





LINK SLED Prosthesis

MITUS ART – Anatomic Reconstruction Technique

Instruments

Surgical Technique

CE 0482

Explanation of Pictograms			
	Manufacturer		Article number
	Material number		Product meets the applicable requirements, which are regulated in the EU harmonization legislation for the affixing of the CE marking.

LINK SLED Prosthesis with MITUS ART Instrument Set

This surgical technique guide was written in conjunction with:
Mr. Sean O'Leary FRCS (TR & Orth), Department of Trauma and Orthopaedics,
Royal Berkshire NHS Foundation Trust, Reading UK, www.readingkneeunit.co.uk
We would like to thank him for his valuable contribution.

Surgical Technique

- 02 Patient Selection and Surgical Planning
- 03 Patient Positioning and Surgical Approach
- 04 Tibial Resection
- 05 Assembly and Application of the Extramedullary Tibial Guide
- 11 Femoral Component Positioning/Alignment
- 12 Femoral Cartilage Removal
- 13 Femoral Preparation
- 14 Tibial Preparation
- 15 Tibial Preparation: All-poly Component
- 17 Tibial Preparation: Metal-backed Component
- 18 Trial Reduction
- 18 Implantation and Cementation
- 20 Final Reduction
- 21 Optional: Femur First

Implants

- 22 Femoral Components
- 22 Tibial Plateaus – all-polyethylene
- 23 Tibial Plateaus – metal-backed

Instruments

- 24 MITUS ART Instrument Set
- 25 Case – Tibia Resection
- 26 Case – Tibia Preparation
- 28 Case – Femur Preparation
- 29 Accessories: Adapter, Sawblades, X-Ray Templates, Further Information
- 31 Important Information for X-ray Investigations
- 32 Indications/Contraindications
- Important Information

Patient Selection and Surgical Planning

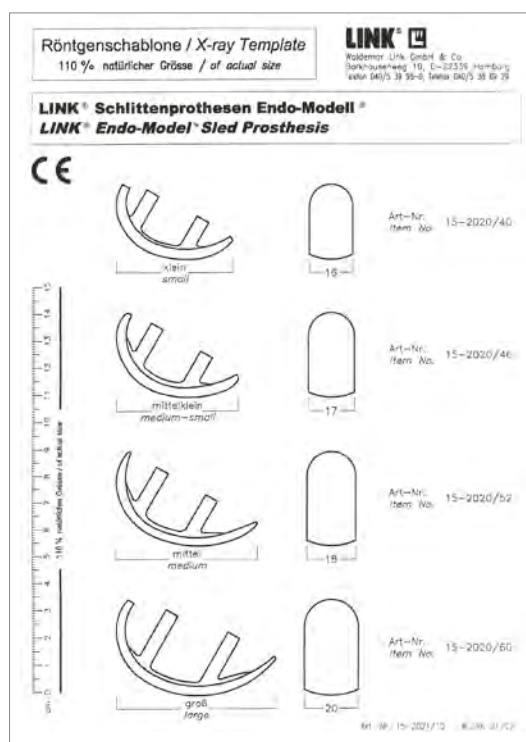

Imaging:

Pre-operative planning is an essential part of the surgery.

The following baseline radiographs are recommended; Weight bearing AP views or Rosenberg PA view taken in slight flexion are essential. These may be supplemented by varus/valgus stress views and Rosenberg view to ensure a correctable deformity. True lateral (femoral condyles overlapping) to assess for posterior tibial plateau erosion seen with chronic ACL deficiency. Skyline PFJ view.

X-ray Templates of the individual components (femur and tibia) which are 110% the actual size are available. A note should be made of the natural tibial slope which will act as a guide during the tibial resection. These views may be supplemented by a long leg X-ray to determine the pre-operative weight bearing axis and any extra-articular deformity. We also support electronic computerized planning and cooperate with the leading manufacturers of electronic templating systems. We would be pleased to provide you with more information on request.

The MITUS ART Instruments are suitable both for the traditional approach and for a less invasive approach, producing less soft tissue damage. When the instruments are used as described below, the intervention can be performed with a small incision yet maximum precision.

Patient Positioning and Surgical Approach

Positioning

Following general/spinal anaesthesia and application of a tourniquet (optional), the patient is placed in the supine position and the flexion range of the knee joint is checked. It should be possible to flex the knee at least 120°. Coverage of the tibia and ankle should not be too thick in order to reliably determine the center of the ankle for later application of the tibial jig.

Suggested Approach: Medial UKR

With the knee flexed 90°, a medial paramedian skin incision is made extending from a point 4 cm above the patella to a point midway between the tibial tuberosity and the joint line. A medial para patellar (omega) capsular incision is made which runs along the side of the patella tendon (1).

We recommend partial excision of the fat pad to allow direct visualization of the lateral wall of the medial femoral condyle.

A medial meniscectomy is performed taking care to protect the superficial meniscal attachment to the medial collateral ligament. The osteophytes are then removed from the medial and lateral borders of the medial femoral condyle and the medial border of the tibial plateau to define the true borders.

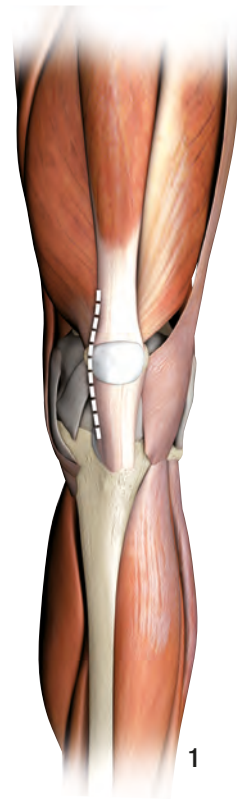

1

Finally the leg is fully extended and a horizontal line is marked on the femoral condyle to demarcate the future anterior margin of the femoral prosthesis (2.1). If the femoral component projects beyond this mark, there is an increased risk of patellar impingement (2.2).

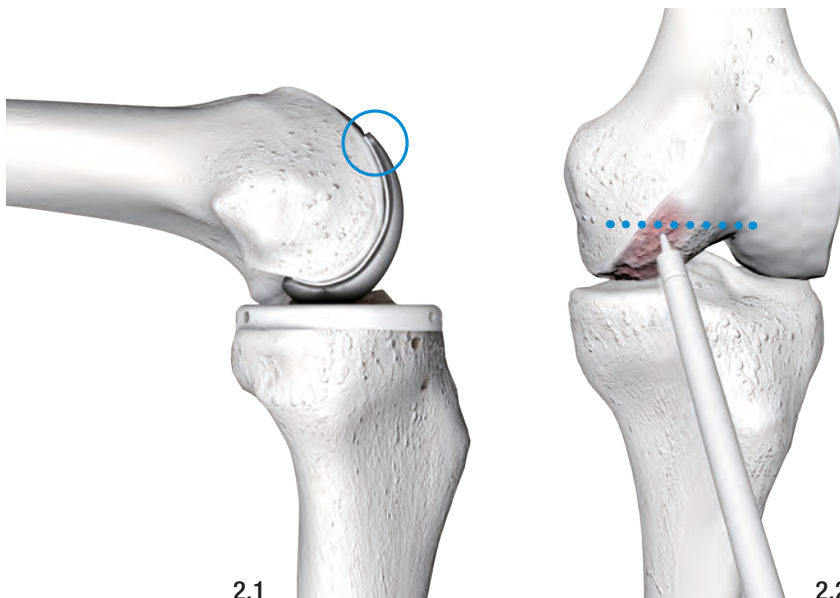

2.1

2.2

Tibial Resection

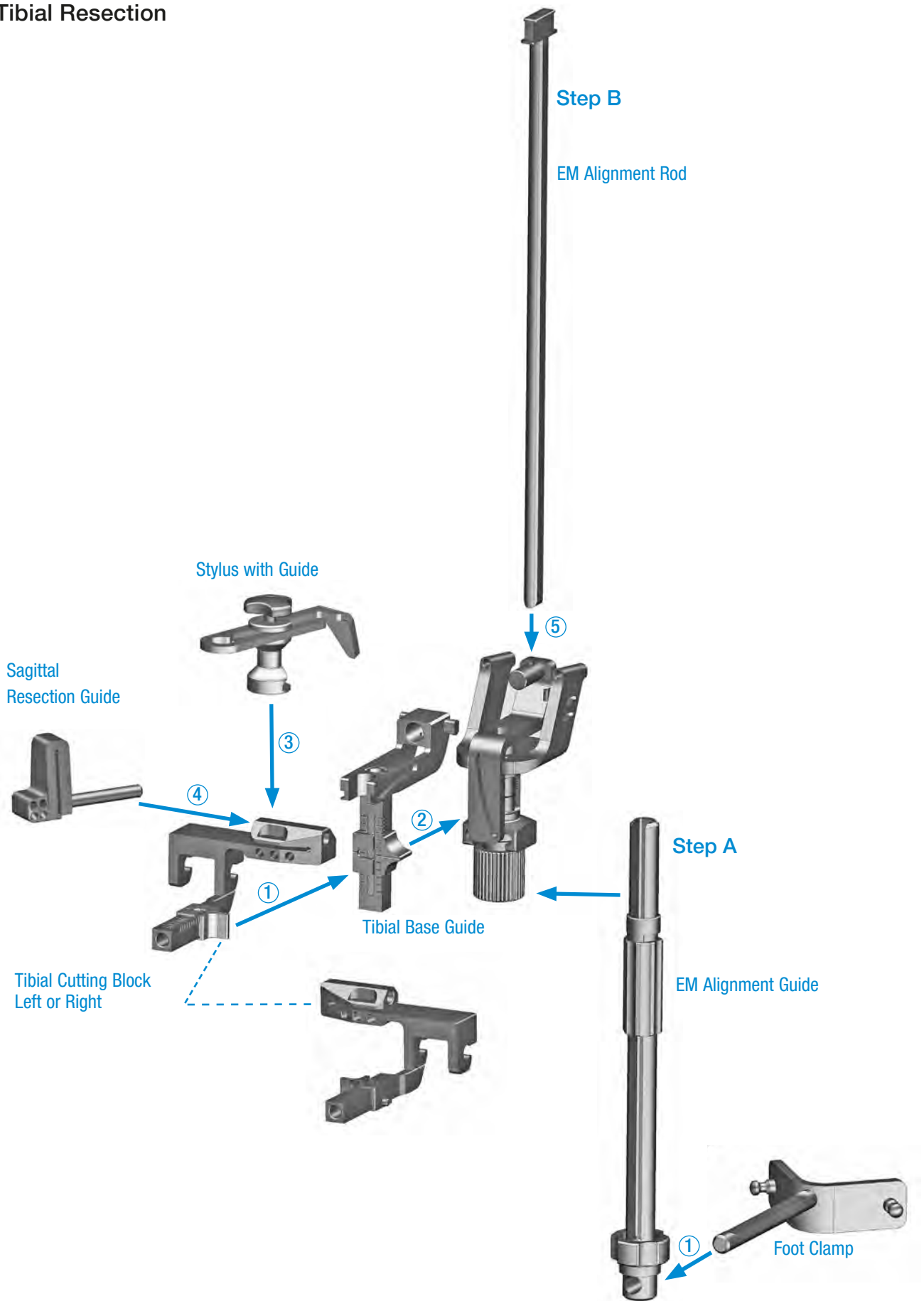

Assembly and Application of the Extramedullary Tibial Guide

(Instrument Sets 35-1000/01)



3.1

Slide the Tibial Cutting Block (Left or Right) 90° onto the proximal end of the Tibial Base Guide (3.1).

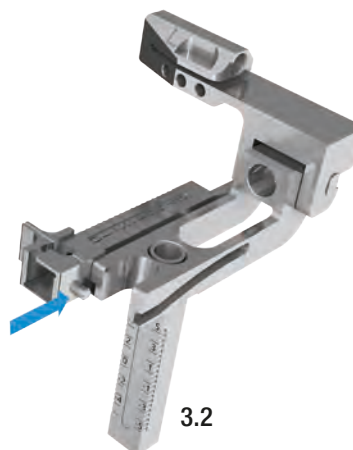

3.2

Insert the Posterior Slope Selector onto the Tibial Cutting Block and position it at “0” (3.2). Be sure that the Selector Pin is inserted into the slot of the Tibial Base Guide.

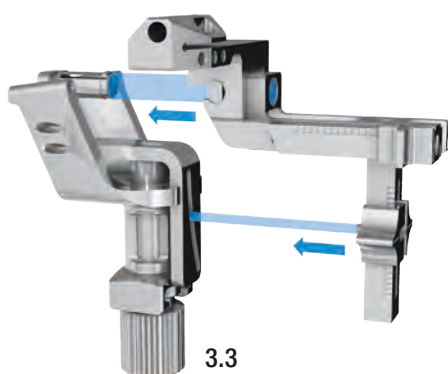

3.3

Slide the Tibial Cutting Block Assembly into the Tibial Base Guide.

Be sure that the big peg of the Tibial Base Guide is aligned with the hole on the proximal end of the Tibial Cutting Block Assembly (3.3).

Attention:

Set the resection micro adjustment to ‘neutral’.

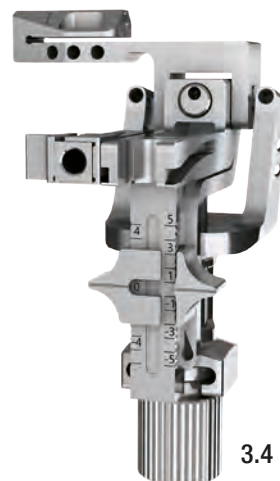

3.4

Tibial Cutting Block Assembly (3.4).

Position all Selectors (posterior slope and varus/valgus adjustment) at “0”.



Fixation at the ankle is achieved either by the Silicone Strap or the optional Spring Clamp and is then assembled to the EM Guide and positioned. The Alignment Guide is positioned parallel to the tibial shaft axis by releasing the Set Screw and pushing the EM Guide in an anterior-posterior direction until the desired position is achieved. The Set Screw is then tightened again (3.5).

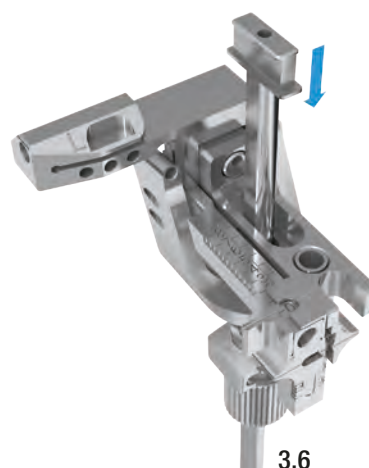

The EM Alignment Rod is pushed through the Tibial Cutting Block Assembly (3.6).

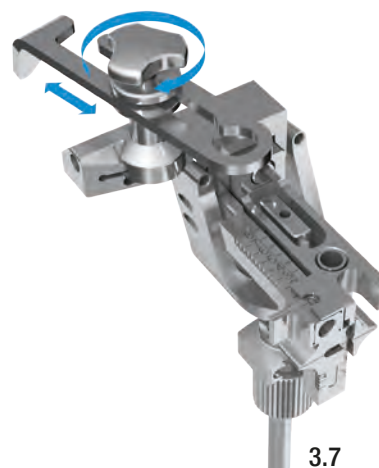

The 5-mm Stylus (optional 7 mm) is inserted in the Guide and positioned on the Tibial Base Frame. We recommend measuring an initial 5 mm initial bony cut from the anterior aspect of the tibial defect. This allows for the use of a 7-mm Component (5 mm bone + 2 mm cartilage) (3.7).

Attention:

The Stylus knob is locking the Stylus assembly to the Tibial Cutting Block Assembly.

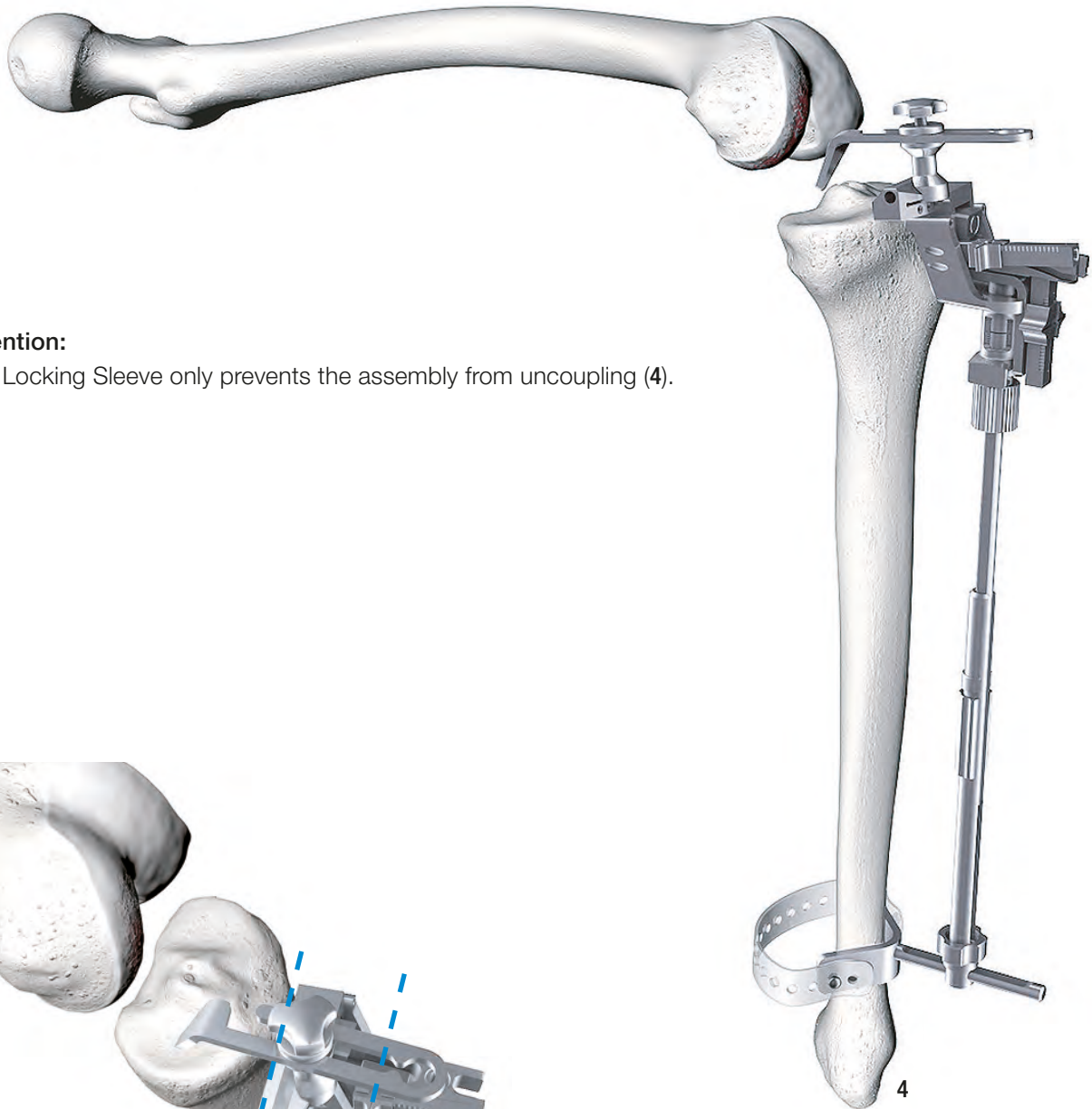

Attention:
The Locking Sleeve only prevents the assembly from uncoupling (4).

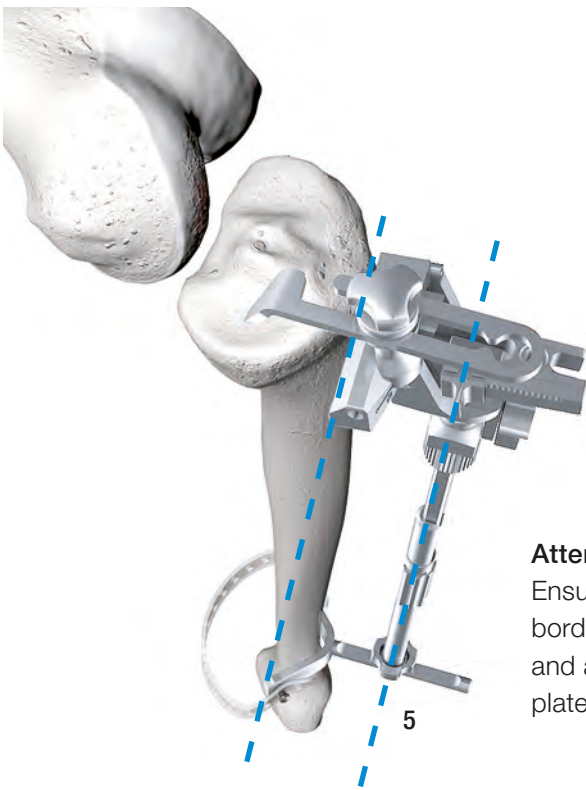

Attention:
Ensure that the Alignment Rod is parallel with the anterior border of the tibial shaft (to realise the preset posterior slope) and also in the mechanical axis of the tibia (mid-point of plateau to mid-point of ankle joint) (5).

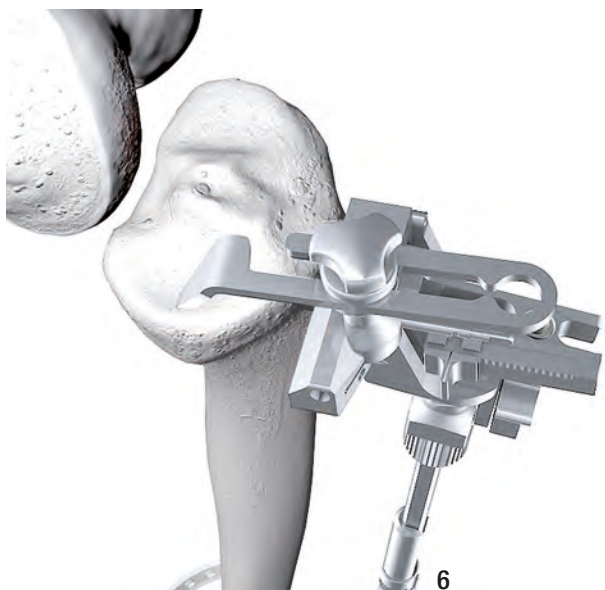

Determine the height of resection. The 5-mm Stylus is used and should reference from the anterior margin/ edge of the chondral defect. A good view must be ensured for this (if necessary open the joint slightly using a lamina spreader) (6).



Attention:

The correct alignment and height of resection can be checked using the Cutting Template through the cutting slots for the saw (7).

The eminentia intercondylaris and in particular the insertion of the anterior cruciate ligament serve for orientation.

Attention: The sagittal cut should be made just medial to the ACL attachment point on the tibial spine in order to maximize the size of the tibial base

The Tibial Base Frame initially is secured medially with a Drill Pin.

Attention: Sufficient initial stability is usually achieved by the single Pin and the Foot Clamp. If necessary an additional Drill Pin can be inserted medially (*).

The Guide with Stylus is removed. Fine adjustments can then be made for precise tibial resection (8).

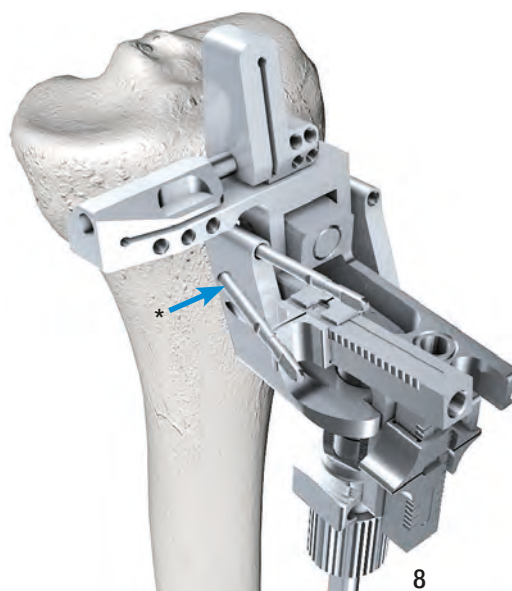

Optional: Fine adjustments for the tibial resection

Posterior Slope (9 A)

Orientation of the posterior slope to the natural preoperative situation, so that the biomechanics of the individual patient are not changed. The resection can be checked for control purposes. It should have the same thickness ventral-dorsal parallel. If an uneven cut is made it can be recut/adjusted in 1° steps.

Attention: Kinematic results suggested that 5° to 7° of posterior slope were preferable, and that excessive posterior slope (> 7°) should be avoided.

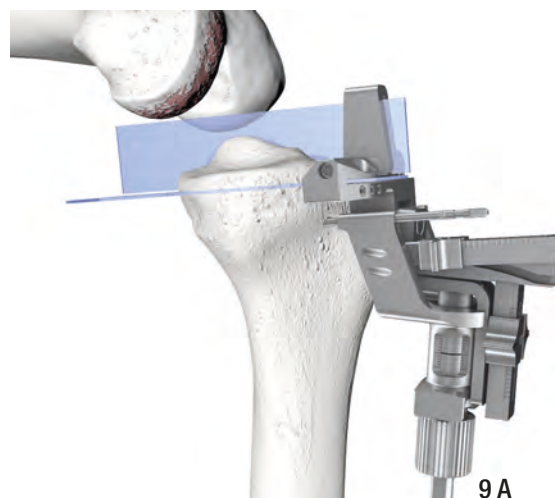

Varus-valgus Adjustment (9B)

Precise varus or valgus alignment is possible with fine adjustment.

Warning: Overcorrection in valgus should be avoided under all circumstances. Position the tibia in 0° to 3° varus. Place the Alignment Rod through the Tibial Cutting Block Assembly to check position of the cut plane to avoid overcorrection.

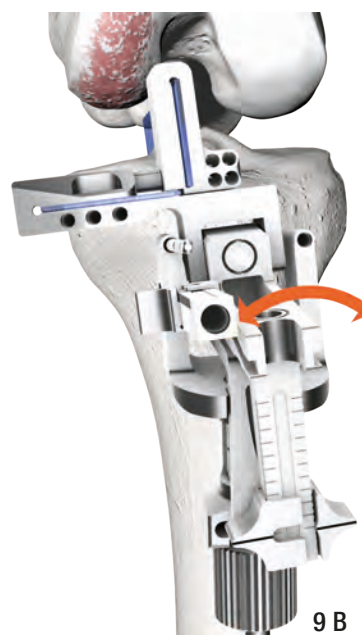

Tibial Resection Height (9 C)

Fine-tune of the resection height is possible by acting on the micro adjustment screw.

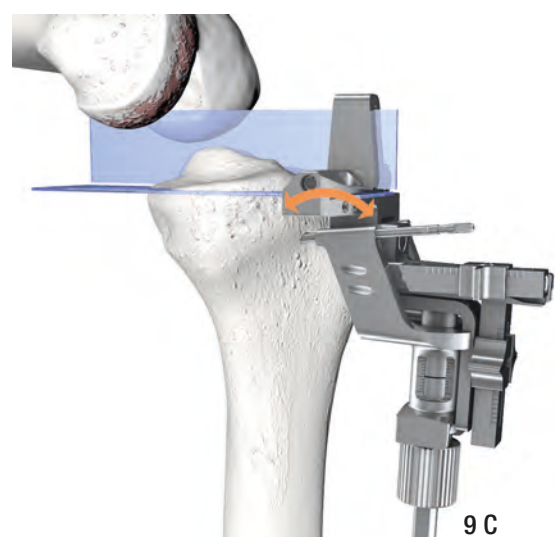

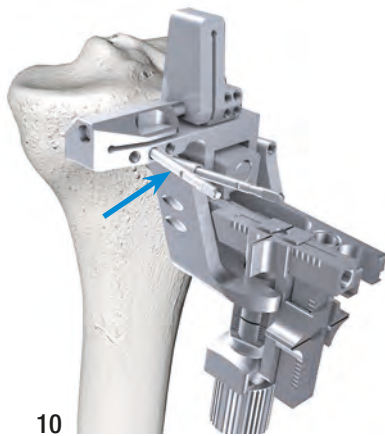

10

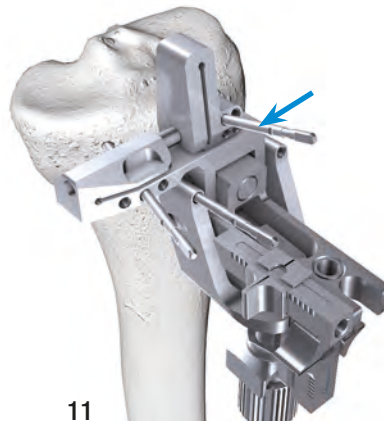

11

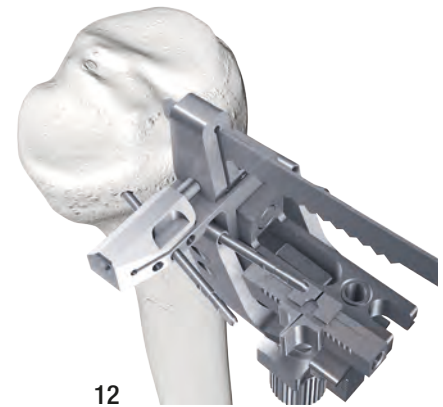

12

After a final inspection of the proposed tibial resection, the Tibial Cutting Block (10) and (if desired) the Sagittal Resection Guide are then fixed with a Drill Pin (11). The reciprocating Saw is introduced through the vertical slot and should be in line with the lateral border of the medial femoral condyle (12). The cut should be in the AP direction. The sagittal Saw is then introduced through the cutting slot (13). Care must be taken to ensure no damage is done to the superficial MCL, which may be protected with a Retractor.

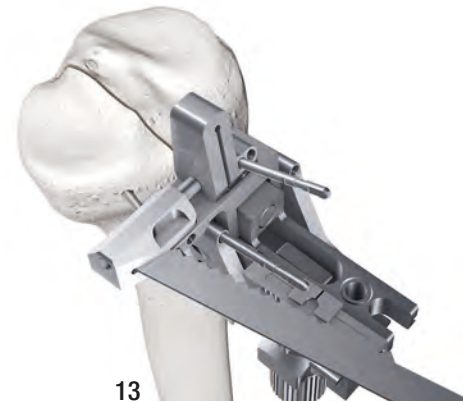

13

The Drill Pins for the Tibial Cutting Block and the Sagittal Resection Guide are removed and then the Sagittal Resection Guide with the Tibial Cutting Block are removed from the Tibial Base Frame (14). If, later on, it becomes evident that the joint space is too small, the Tibial Cutting Block can be simply repositioned and, after correcting the height setting, resection can be performed again.



14

The resected Plateau is then inspected to assess its thickness and the evenness of the cut in the AP and medial/lateral planes. The Plateau can then be sized by comparison with the Tibial Templates. It is important to ensure that all bony fragments/retained resection material and meniscal remnants are removed from the posterior aspect of the joint to allow easy positioning of the appropriate Femoral Drill Guide.

A 7-mm Trial is provided to insert onto the resected Plateau which allows assessment throughout the range of motion (15).

Attention: Check that there is no overcorrection. The tibia plateau should be in 0° to 3° varus.

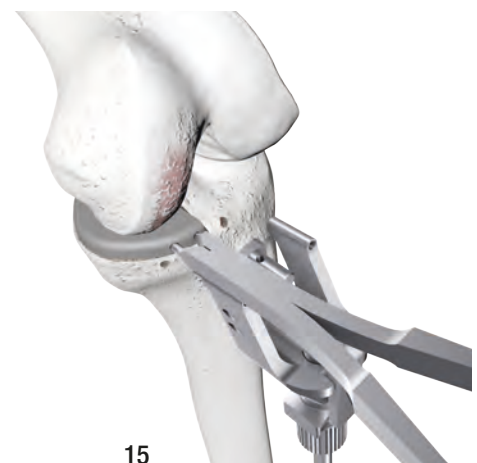

15

Femoral Component Positioning / Alignment

The positioning of a Unicondylar Sled Prosthesis onto an anatomically unique femoral condyle will always involve a degree of compromise. However there are certain guidelines to aid in the positioning of the implant.

Femoral – Tibial Contact

In an attempt to prevent edge loading of the Tibial Component the femoral prosthesis should be positioned in order to be in contact with the center of the Tibial Plateau. Marks can be made on the femoral condyle during cyclical flexion/extension which correspond to the contact point of the femoral condyle with the centre of the Plateau throughout flexion.

Attention: In fixed-bearing medial UKA the optimal target for the surgeon should be a central implantation of the femoral component for expecting the best clinical and biomechanical outcome.



Step 1
Marking of the anterior margin of the femoral prosthesis with the knee in extension.



Step 2
Knee in flexion.

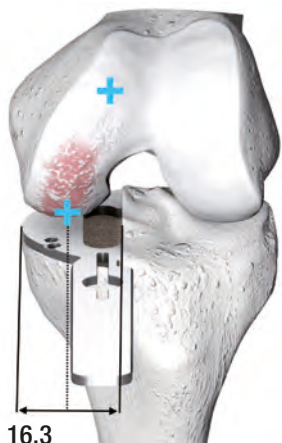

Step 3
Marking of center of the condyle in flexion.

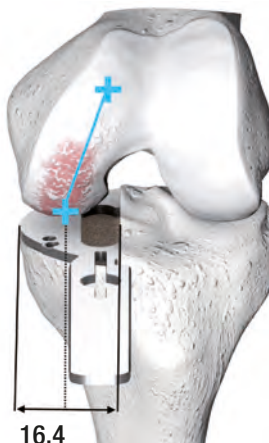

Step 4
Connecting of the two markings. This describes the femoral component alignment.

Option: Position the femoral component perpendicular to the tibia.

Attention: Do not select the femoral component too large in order not to run too far anteriorly.

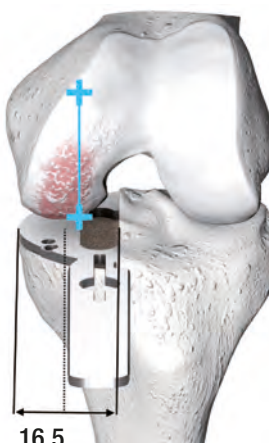

16.5

Femoral Cartilage Removal

Suitable sizing of the Femoral Component required the femoral cartilage to be removed (17). Appropriate instruments for cartilage removal include the burr, Curette, Sharp Spoon or Sawblade. At this stage remove any posterior osteophytes using a curved Osteotome (18).

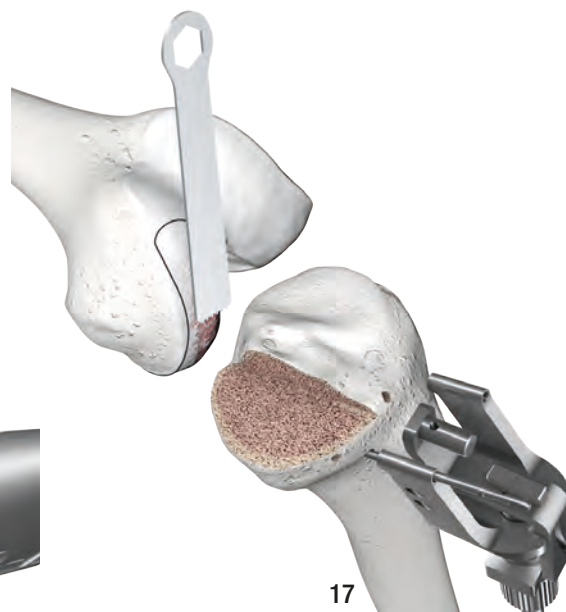
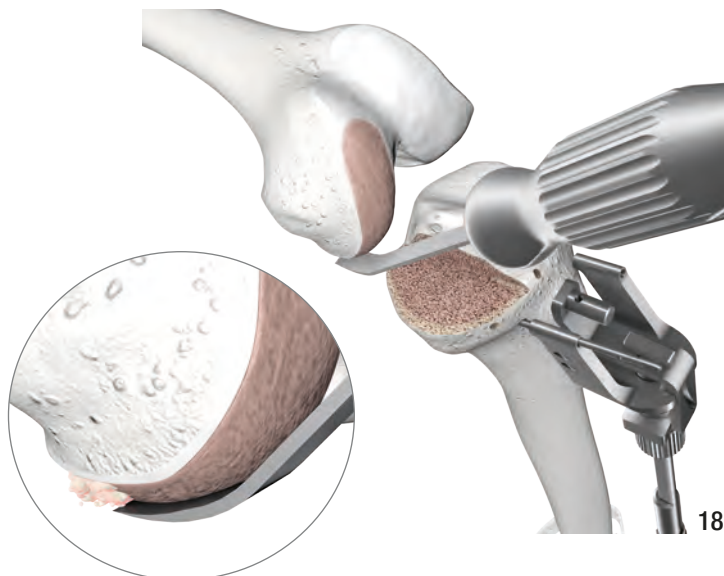

17

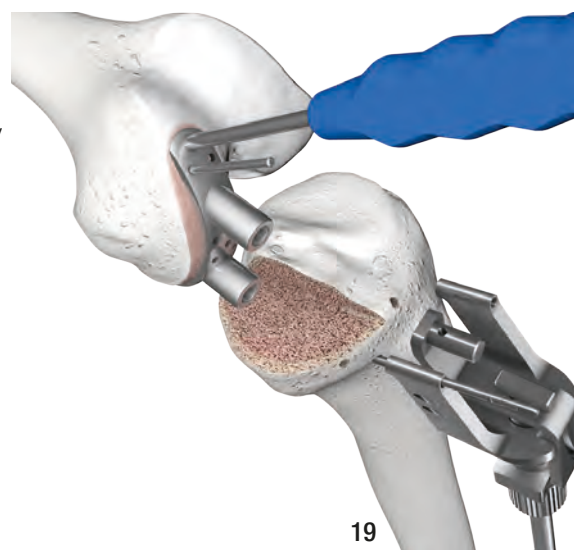

19

The Drill Guides match the component geometries and can be used as a surrogate sizing device. The Drill Guide should cover the femoral condyle to allow tibio femoral contact in deep flexion and extend up to but not significantly beyond the anterior mark made during the approach and avoid any possibility of Tibial Component 'edge loading'. The selected Femoral Drill Guide is fixed with Drill Pins (19).

There are four sizes of the Femoral Component available (40, 46, 52 and 60 mm). The appropriate size is selected using a best fit philosophy.

Femoral Preparation

The fixation holes are drilled using the appropriate femoral drill length (20). The drill stop is to be unlocked using the corresponding Hex Head Screwdriver (319-535/00). The stop is adjusted according to the size of the Femoral Component:

Femoral Size	
Small	S/MS/M
Medium-small	S/MS/M
Medium	S/MS/M
Large	L

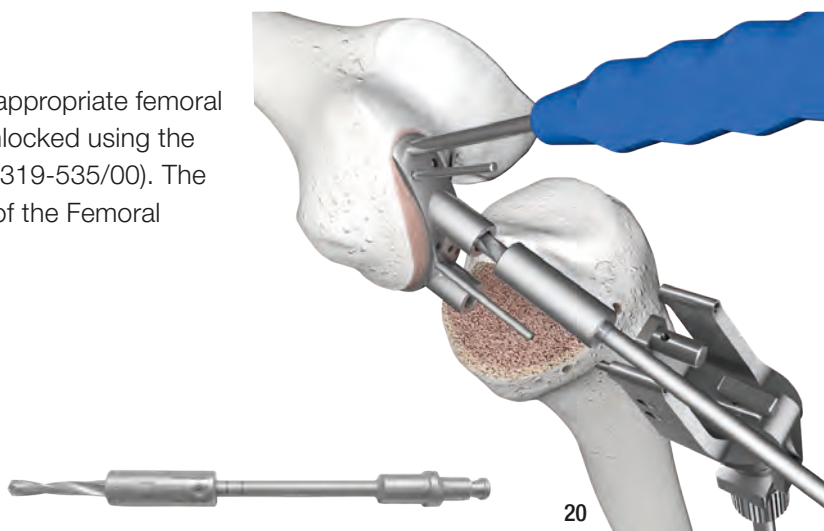

Corresponding to the Femoral Drill Guides there are Femoral Trial Components available. Prior to positioning the trial use a Chisel or an Oscillating Saw to prepare a groove between the two fixation holes ensuring that the fin on the backside of the Femoral Component will fit (21).

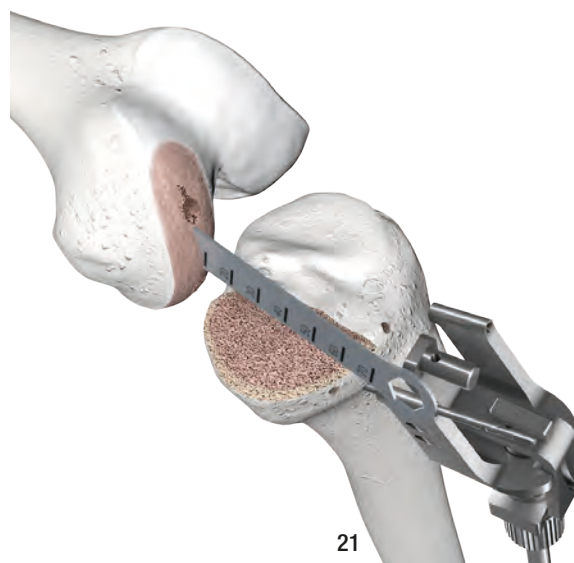

To ensure adequate bony resection and 'balance' a trial reduction is performed. The Trial Sled Prosthesis is placed on the prepared femoral condyle using the Inserting Forceps (22).

Attention: The appropriate orientation for the pegs have to be considered (22.1-22.2).

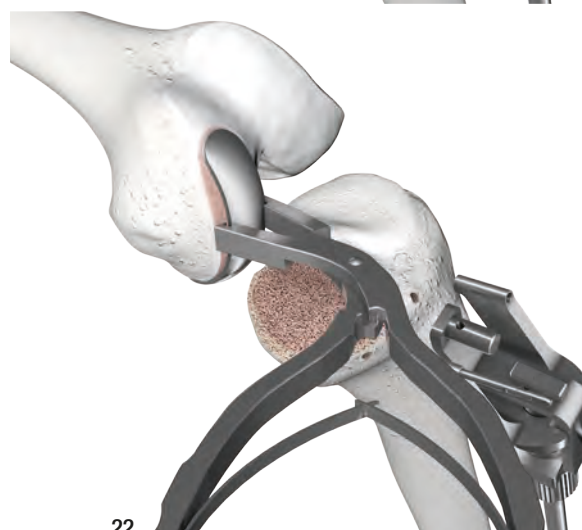

Tibial Spacer Blocks are available in the Instrument Set for evaluating the joint space (23).

If the joint space is too small, the space can be corrected by re-cutting the tibial surface following re-application of the Tibial Jig over the Guide Pin.

If the result is satisfactory, the Tibial Resection Guide is taken off.

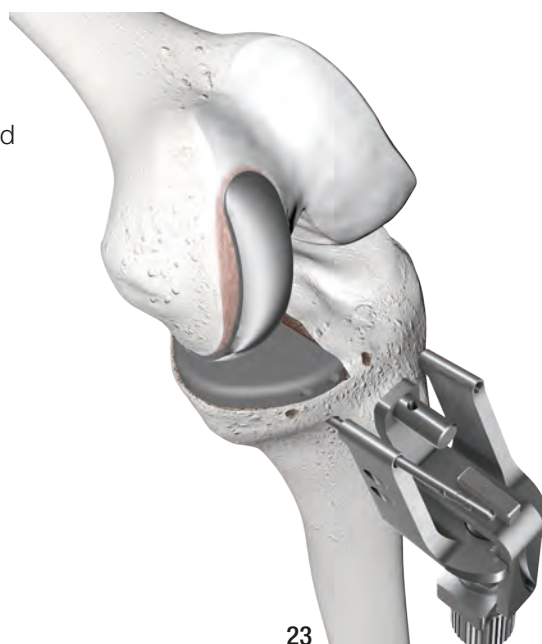

Tibial Preparation

The tibial preparation consists of:

- Sizing and aligning the Tibial Plateau
- Preparation of the Tibial Keel
- Shaping/final preparation of the Tibial Keel

Two options are available for the tibia: a Metal-backed Tibial Component or an All-poly Tibial Component.

Due to the different profile of the backside of the implant the preparation required differs:



All-poly Tibial Component

Preparation can be done with either a Milling System or a Keel Chisel and is concluded using a Bone Compressor.

Metal-backed Tibial Component

Here preparation is done exclusively with a Keel Chisel.

The Tibial Template used is based on the implant decision (metal-backed or all-poly):

All-poly Tibial Components	
	
Size (A/P) mm	Width (M/L) mm
45	22
50	27
55	29
58	31
Metal-backed Tibial Components	
	
Size (A/P) mm	Width (M/L) mm
45	22.5
50	25.0
55	27.5

Tibial Preparation: All-poly Component

The appropriately sized Tibial Template is put into place. It can be used left/right and medial/lateral. The ideal size (a/p) is determined by positioning the hook at the end of Tibial Template posterior of the intercondylar eminence. The Template should be perfectly aligned with the anterior margin of the tibia. Do not undersize (24). The Tibial Template is secured using a **Pin with stop** (Drill Pin with stop 319-566/00 or alternatively Thread Pin with stop 319-560/01) (25).

Attention: It is important to achieve maximal coverage of the tibial plateau. Determine the tibial component as large as possible. However, an overhang, especially anteriorly, should be avoided.

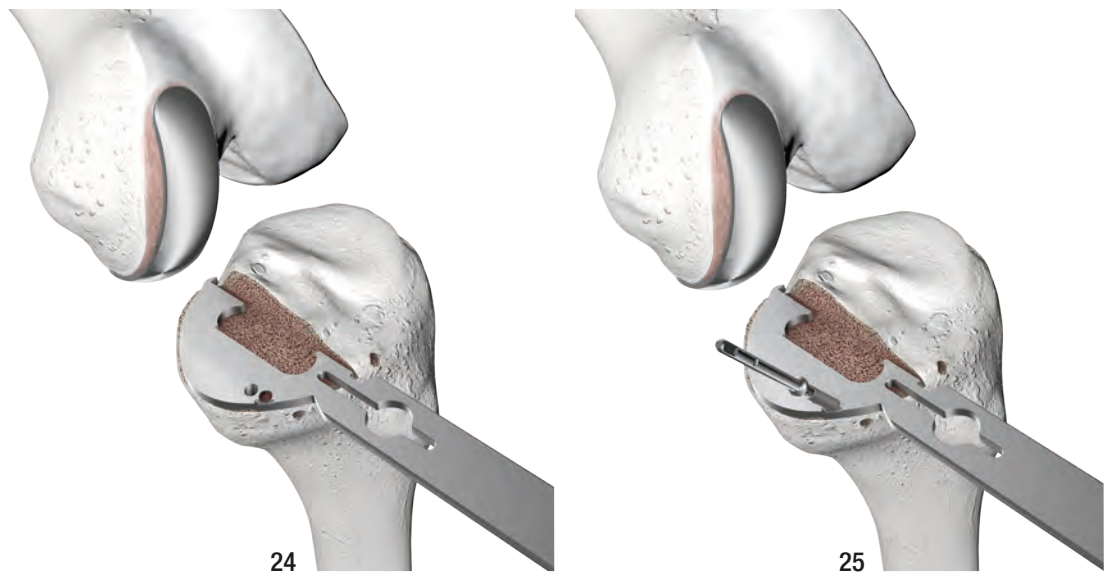

Optional: In case of insufficient stability or poor bone quality, the Tibial Template can be additionally secured by the Mill Fixation Adapter and further Drill Pins (26).

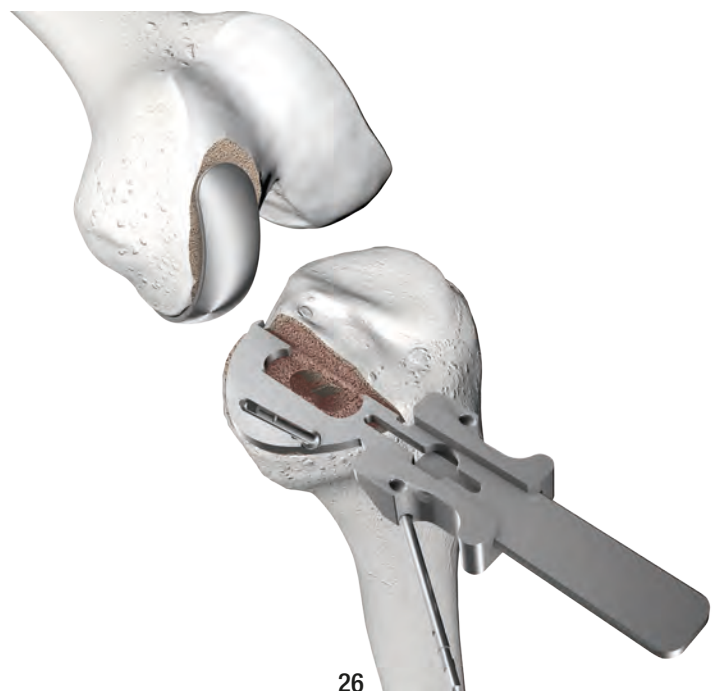

There are two options for preparing the keel.

1. Milling System

The tibial mill limits the depth and AP excursion of the mill and is selected according to the component size.

- The **Tibial Mill Guide** is placed in the Tibial Template in anterior position (27).
- The **Tibial Cutter** is inserted and put into operation, milling is then performed up to the stop and the Tibial Cutter is subsequently removed (28).
- The **Tibial Mill Guide** is pushed toward posterior and the mill is operated up to the stop. Then, with the mill operating, the Tibial Mill Guide is moved toward anterior/posterior in order to prepare the box (29).



Once preparation is complete, the Tibial Cutter is removed followed by the Tibial Mill Guide. For final preparation, the Bone Compressor which corresponds to the selected tibial size is chosen and inserted/impacted into the prepared box (30).

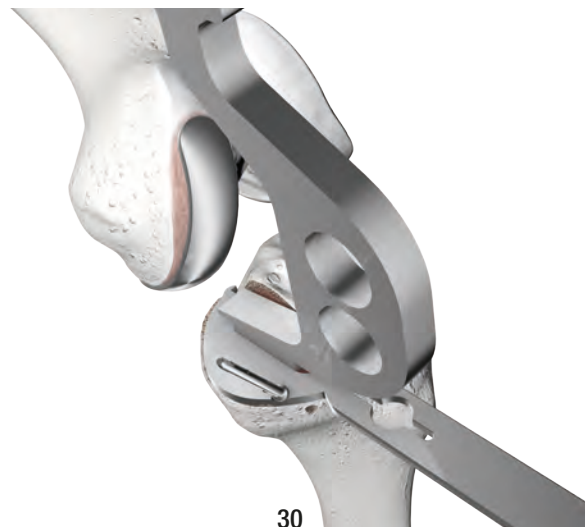

2. Keel Chisel

As an alternative to the Milling System, the box for the Tibial Component can also be prepared with a Keel Chisel. As described above, the Tibial Template is fixed into place in order to determine both size and position.

The tool of the corresponding size is selected, guided through the recess in the Tibial Template and then used for chiseling. The bone block is released by means of a posterior/anterior tilting motion and the Keel Chisel is removed. The Bone Compressor can then be inserted.

Tibial Preparation: Metal-backed Component

For preparation of the keel for Metal-backed Tibial Components there is the dedicated Keel Chisel to be used. As described above, the relevant Tibial Template is placed and fixed onto the tibia in order to determine both size and position (31).

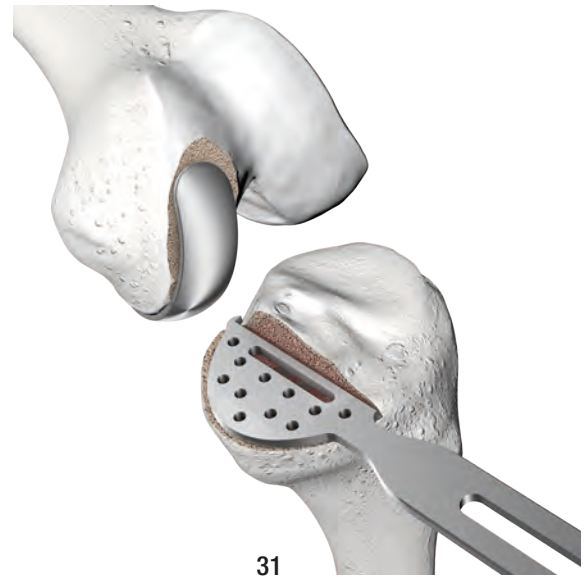

The tool of the corresponding size is selected, guided through the recess in the Tibial Template and then used for chiseling. As such, the bony structure is displaced, compressed and then the Chisel is removed by tilting it posterior/anterior (32).

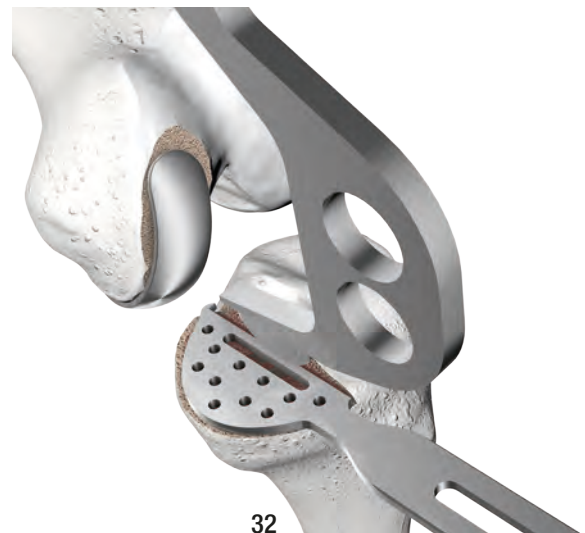

Trial Reduction

The Tibial Trial Prosthesis (with keel) is selected – All-poly (yellow) or Metal-backed (red). As a rule, the smallest Trial Component is used. For this, the knee joint should be flexed at least 90° (33).

Attention:

The Tibial Trial Prosthesis is easier to put into place with slight valgus loading.

The knee is moved through its entire range of motion to check joint stability. The height of the Tibial Component is to be selected so that the natural tension of the ligaments is restored. With valgus loading of the knee joint, it should be possible to open the medial joint space 1-2 mm (34).

Attention: It is important to ensure a slight under correction of the limb alignment and have appropriate ligamentous tension restored (2 - 3 mm of laxity) in flexion and extension.

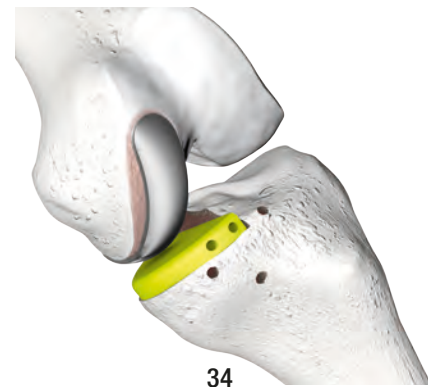

Implantation and Cementation

Warning:

A good fixation of the implant components is a prerequisite to achieve long-term success of the application. Cementing technique is one of the factors that play an important role in this respect. Therefore the following instructions have to be carefully considered.

In sclerotic bone, multiple holes should be drilled with a small drill (Max diam 3.0 mm-drill pins can be used as an alternative) to ensure better bone cement interdigitation. Due to the preparation technique, this is particularly important for the femoral condyle. Cleanse all cement-receiving bone surfaces thoroughly using pulse lavage and dry with a clean, dry lap sponge (35). The Bone Cement is prepared, taking account of the manufacturer's specific instructions.

The implantation of the tibial and femoral components should be done in two stages. This ensures that there is sufficient time to position the component, remove excess bone cement and allow it to harden without inadvertently manipulating the implant-bone cement-bone interface.

The bone cement, which has been prepared according to the manufacturer's instructions, is applied both to the back of the implant and to the bone.

Beginning with the tibial component, the bone cement is carefully applied evenly to ensure a homogeneous cement mantle. A steady pressure is maintained with the tibial impactor during curing.

The femoral component is then cemented.

Important:

Ensure that excess Bone Cement is completely removed and no loose Bone Cement particles remain, especially in the posterior aspect of the joint.



Tibial Component

The Bone Cement is applied to the prepared bony surface including the keel and the underside of the implant.

Attention: It should be considered to apply bone cement at the vertical wall a too.

Apply a thin layer of cement over the entire underside of the tibial component. The cement should just overfill the bead structure on the underside of the tray, up to 1 mm proud posteriorly and 2 mm proud anteriorly.

Apply cement to the tibia and pressurize the cement, striving for penetration of 3-4 mm.

Use of a cement gun/cartridge equipped with a pressurizing nozzle is recommended to deliver and pressurize cement into the prepared holes and across the flat surface.

Alternatively, cement may be applied manually and pressurized into the bone using a flat osteotome.

The Tibial Component is inserted posteriorly initially, then pushed downward and finally pushed in anteriorly (36).

Attention: To facilitate placement, the knee is flexed and the tibia is externally rotated.

Femoral Component

The Bone Cement is applied to the back of the Femoral Component. In addition, both drill holes for the fixation pegs are filled with Bone Cement. The Femoral Component is positioned using Inserting Forceps and both pegs are to be inserted into the prepared drill holes (37). The Femoral Component is then finally driven on using the Femoral Impactor (38).

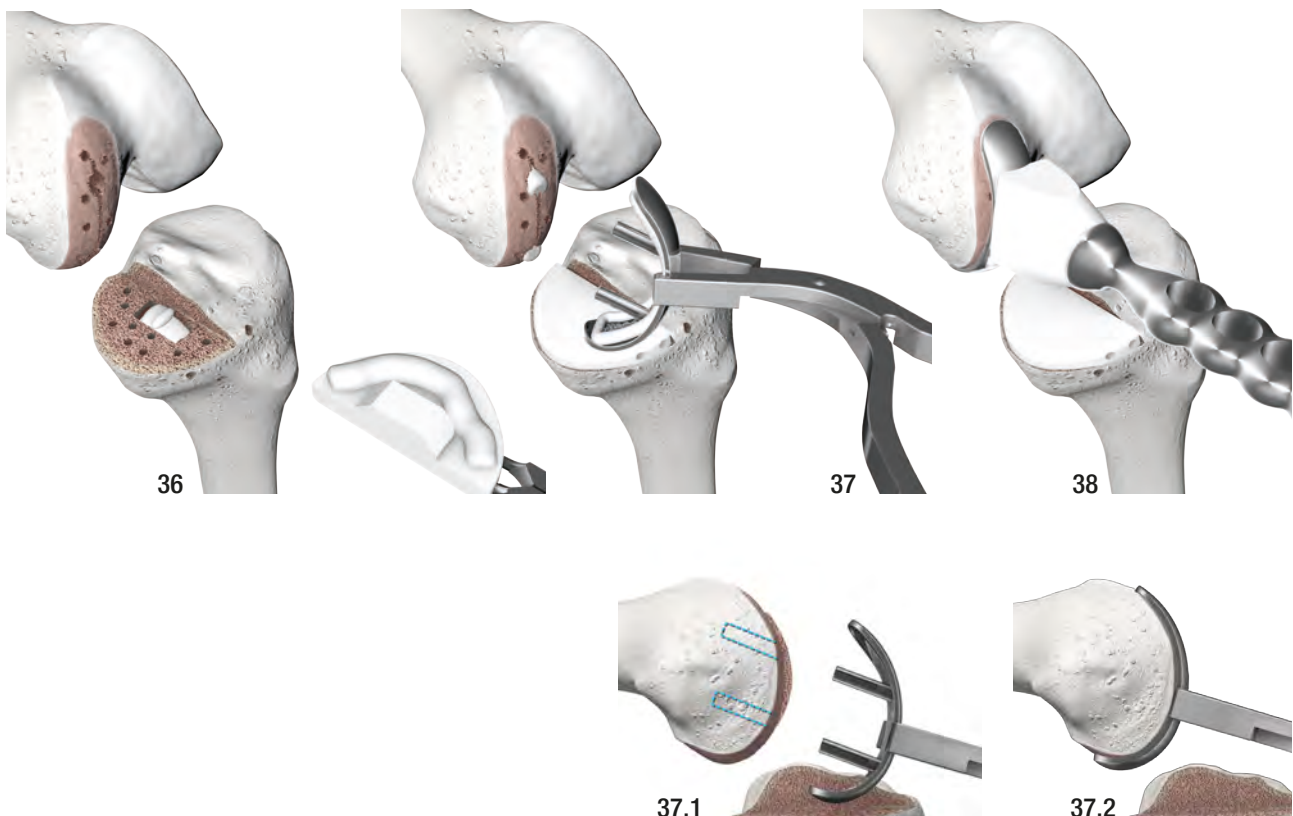

Final Reduction

The leg is held in extension for the remainder of the cement curing process (39).



Optional: Femur First

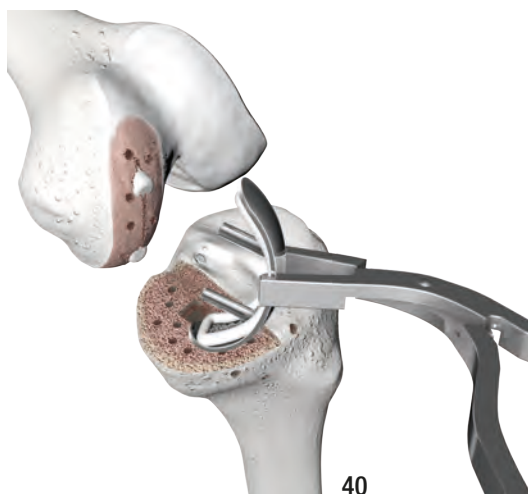

Femoral Component

The Bone Cement is applied to the back of the Femoral Component. In addition, both drill holes for the fixation pegs are filled with Bone Cement. The Femoral Component is positioned using Inserting Forceps and both pegs are to be inserted into the prepared drill holes (40). The appropriate orientation for the pegs should be considered (40.1 & 40.2).

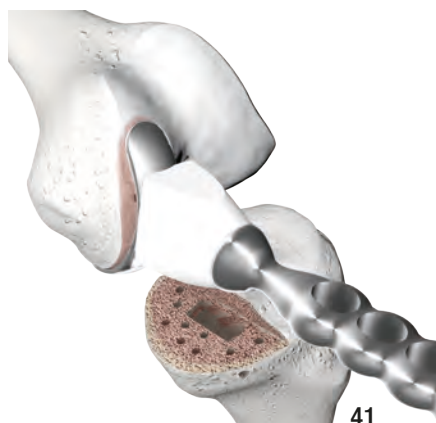
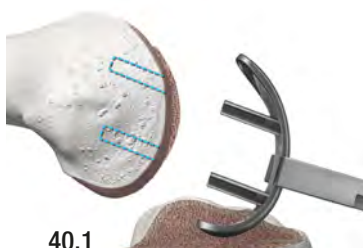

The Femoral Component is then finally driven on using the Femoral Impactor (41).

Tibial Component

The Bone Cement is applied to the prepared bony surface and the underside of the implant.

Attention: It should be considered to apply bone cement at the vertical wall a too.

Apply a thin layer of cement over the entire underside of the tibial component. The cement should just overfill the bead structure on the underside of the tray, up to 1 mm proud posteriorly and 2 mm proud anteriorly.

Apply cement to the tibia and pressurize the cement, striving for penetration of 3-4 mm.

Use of a cement gun/cartridge equipped with a pressurizing nozzle is recommended to deliver and pressurize cement into the prepared holes and across the flat surface.

Alternatively, cement may be applied manually and pressurized into the bone using a flat osteotome. The Tibial Component is inserted posteriorly initially, then pushed downward and finally pushed in anteriorly (42 & 43).

Attention: To facilitate placement, the knee is flexed and the tibia is externally rotated.



Femoral Components

MAT CoCrMo or CoCrMo/TiNbN

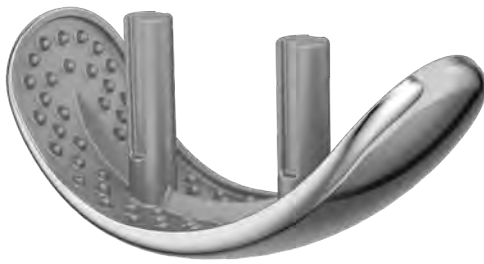

REF CoCrMo	REF CoCrMo/ LINK PorEx*	Size	Width (K) mm	Length (T) mm
15-2020/40	15-2220/40	small	16	40
15-2020/46	15-2220/46	medium small	17	46
15-2020/52	15-2220/52	medium	18	52
15-2020/60	15-2220/60	large	20	60

* LINK PorEx: TiNbN = Titanium Niobium Nitride; hypoallergenic coating (gold colour).

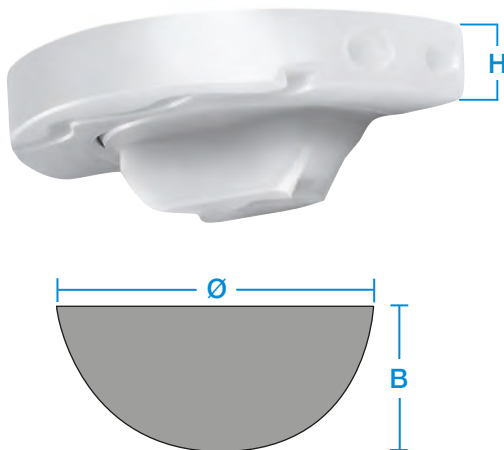
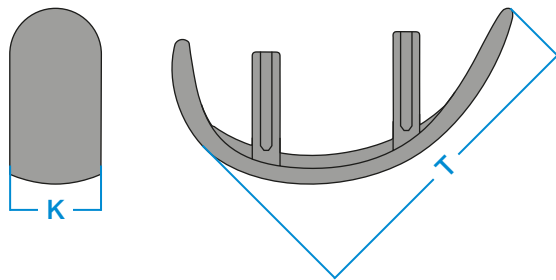

Tibial Plateaus – All-polyethylene

MAT UHMWPE/ CoCrNiMoFe

REF UHMWPE/ CoCrNiMoFe	Height (H) mm	Ø mm	Width mm
15-2028/01	7	45	22
15-2028/02	9	45	22
15-2028/03	11	45	22
15-2028/04	13	45	22
15-2028/05	7	50	27
15-2028/06	9	50	27
15-2028/07	11	50	27
15-2028/08	13	50	27
15-2028/09	7	55	29
15-2028/10	9	55	29
15-2028/11	11	55	29
15-2028/12	13	55	29
15-2028/13	7	58	31
15-2028/14	9	58	31
15-2028/15	11	58	31
15-2028/16	13	58	31

Important information:

Tibial Components of 7-mm high offer the advantage of particular bone preservation and allow for a good range of motion. The suitability of these particular components have to be medically indicated. The Tibial Components of 7-mm high are not suitable for obese or very active patients.

Tibial Plateaus – metal-backed

MAT CoCrMo or CoCrMo/TiNbN, UHMWPE

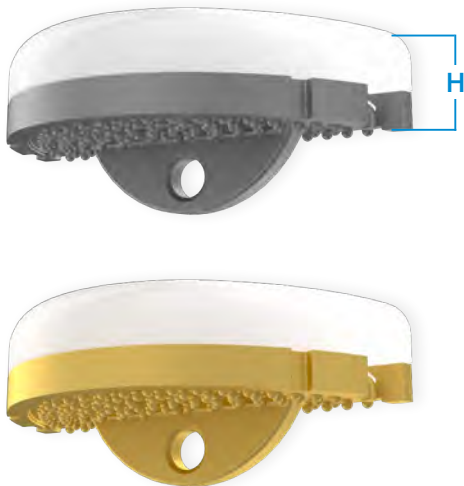

REF CoCrMo	REF CoCrMo/ LINK PorEx*	Height (H) mm	Ø mm	Width (B) mm
15-2030/13	15-2230/13	8	45	22.5
15-2030/02	15-2230/02	9	45	22.5
15-2030/03	15-2230/03	11	45	22.5
15-2030/04	15-2230/04	13	45	22.5
15-2030/14	15-2230/14	8	50	25.0
15-2030/06	15-2230/06	9	50	25.0
15-2030/07	15-2230/07	11	50	25.0
15-2030/08	15-2230/08	13	50	25.0
15-2030/15	15-2230/15	8	55	27.5
15-2030/10	15-2230/10	9	55	27.5
15-2030/11	15-2230/11	11	55	27.5
15-2030/12	15-2230/12	13	55	27.5

* LINK PorEx: TiNbN = Titanium Niobium Nitride; hypoallergenic coating (gold colour).

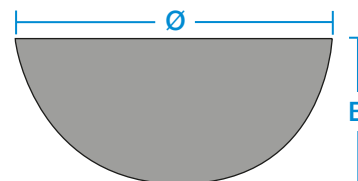

MITUS ART Instrument Set (Anatomic Reconstruction Technique)

Greater Safety
and Higher Precision

- Instrument Set for optimal alignment and soft tissue adjustment with reproducible results
- The Instruments are arranged on the Trays in the correct surgical sequence
- All the Instruments can be dismantled without tools and are quick and easy to reassemble



REF	MITUS ART Instrument Set
35-1000/01	Case – Tibia Resection
35-1100/00	Case – Tibia Preparation
35-2100/00	Case – Femur Preparation

35-1000/01 Case – Tibia Resection

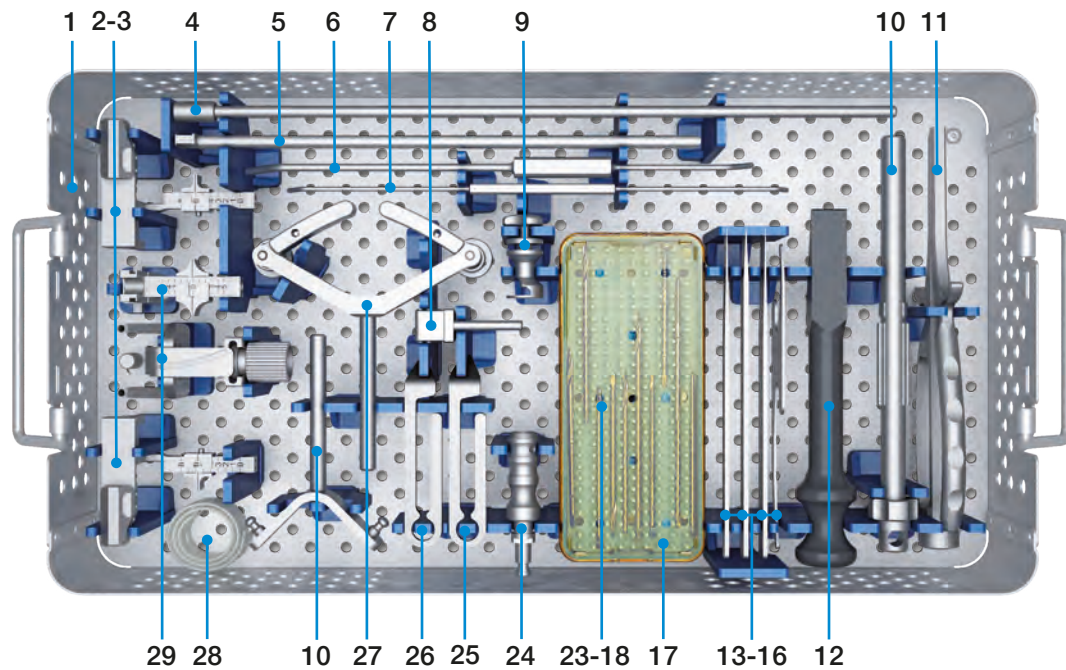

1	35-0100/01	Instruments Tray – Tibia Resection , empty, 485 x 253 x 80 mm
2	35-1002/00	Tibial Saw Guide , asymmetrical, right
3	35-1001/00	Tibial Saw Guide , asymmetrical, left
4	319-520/01	Alignment Rod , extramedullary
5	319-110/01	EM Alignment Rod , for tibia alignment
6	15-2201/70	Curette to remove excess cement
7	15-2201/71	Spatula , double end, to remove excess cement
8	35-1003/00	Tibial Sagittal Resection Guide
9	35-1004/00	Guide for stylus
10	319-160/00	Foot Clamp , EM tibial alignment (2 parts)
11	317-586	Inserter/Extraction Forceps , for fixation pins Ø 3 mm
12	35-1017/00	Tibial Impactor
13	317-802/53	Cutting Template
14	15-2102/03	Lambotte Osteotome , width 15 mm
15	15-2201/17	Lambotte Osteotome , width 11 mm
16	15-2201/16	Lambotte Osteotome , width 9 mm
17	319-602/30	Sterilizing Box with base, silicon mat and top consisting of:
18	319-560/01	Thread Pin , Ø 3.5 mm, 70 mm (2 pieces)
19	319-566/00	Drill Pin with stop, Ø 3.0/3.5 mm, 85 mm (2 pieces)
20	319-581/00	Drill Pin , Ø 3 mm, 80 mm (3 pieces)
21	319-582/00	Drill Pin , Ø 3 mm, 110 mm (2 pieces)
22	35-1020/08	Self-tapping Fixation Pin , Ø 3 mm, 80 mm (3 pieces)
23	35-1021/00	Locking Socket , for tibia alignment rod (1 piece)
24	16-3287/00B	Adapter , LINK power tool snap lock adapter
25	35-1005/00	Stylus , height 5 mm
26	35-1007/00	Stylus , height 7 mm
27	319-183/00	Foot Clamp , spring fixation
28	317-538/01	Plastic Connector , 495 mm
29	319-140/01	Tibial Base Guide (2 parts)

35-1100/00 Case – Tibia Preparation

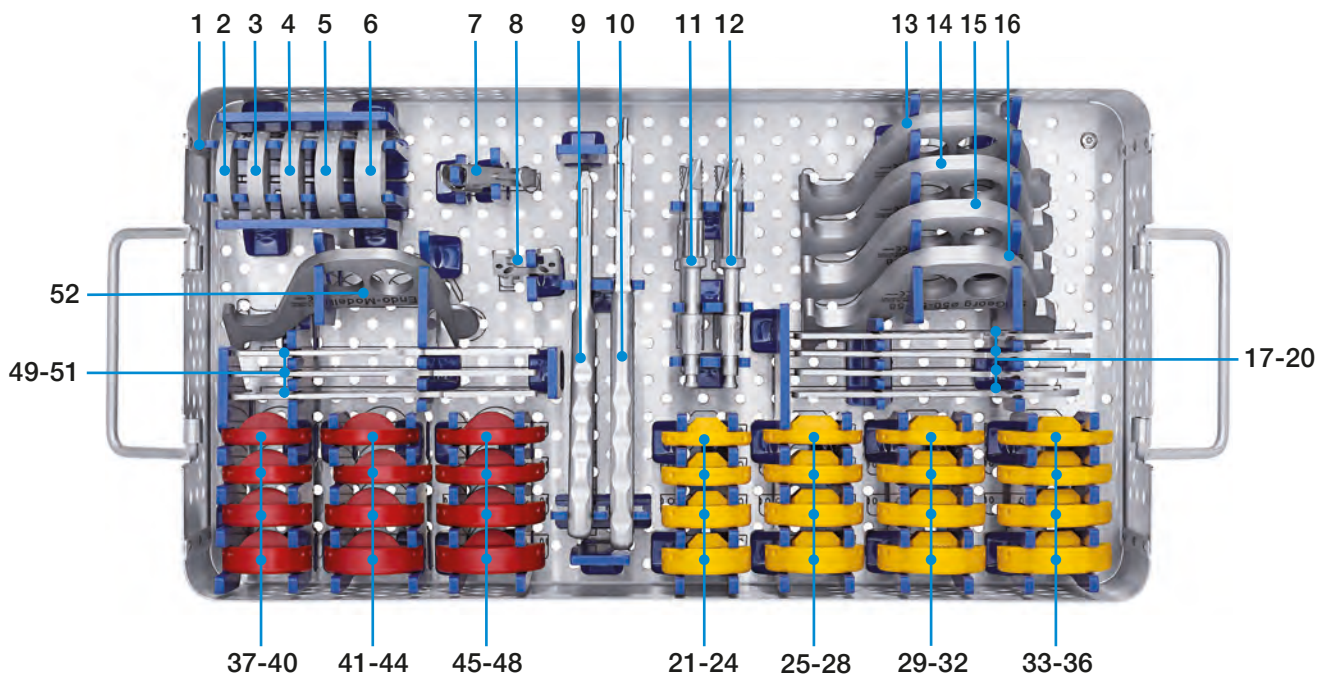

1	35-0110/00	Instruments Tray – Tibia Preparation, empty, 485 x 253 x 80 mm
		Tibial Trial Plates, Ø 45 mm
2	35-1012/07	Height 7 mm
3	35-1012/08	Height 8 mm
4	35-1012/09	Height 9 mm
5	35-1012/11	Height 11 mm
6	35-1012/13	Height 13 mm
7	35-1010/00	Tibia Milling Guide
8	35-1011/00	Milling Fixation Block
9	15-2040/09	Plateau Holding and Inserting Forceps, for tibial plateaus (metal-backed)
10	15-2042	Inserting Forceps, for tibial trial prosthesis (all-poly) and tibial plateaus (all-poly)
11	35-1008/00	Tibial Cutter, small, for tibial plateaus (all-poly) Ø 45 mm
12	35-1009/00	Tibial Cutter, large, for tibial plateaus (all-poly) Ø 50, 55, 58 mm
13	35-1013/00	Keel Chisel, for tibial plateaus (all-poly), Ø 45 mm
14	35-1015/00	Bone Compressor, for tibial plateaus (all-poly), Ø 45 mm
15	35-1014/00	Keel Chisel, for tibial plateaus (all-poly), Ø 50, 55, 58 mm
16	35-1016/00	Bone Compressor, for tibial plateaus (all-poly), Ø 50, 55, 58 mm
		Tibial Templates for tibial plateaus (all-poly)
17	35-1158/00	Ø 58 mm
18	35-1155/00	Ø 55 mm
19	35-1150/00	Ø 50 mm
20	35-1145/00	Ø 45 mm

Tibial Trial Prostheses, for tibial plateaus (all-poly)		
21	35-1145/07	Ø 45 mm, Height 7 mm
22	35-1145/09	Ø 45 mm, Height 9 mm
23	35-1145/11	Ø 45 mm, Height 11 mm
24	35-1145/13	Ø 45 mm, Height 13 mm
25	35-1150/07	Ø 50 mm, Height 7 mm
26	35-1150/09	Ø 50 mm, Height 9 mm
27	35-1150/11	Ø 50 mm, Height 11 mm
28	35-1150/13	Ø 50 mm, Height 13 mm
29	35-1155/07	Ø 55 mm, Height 7 mm
30	35-1155/09	Ø 55 mm, Height 9 mm
31	35-1155/11	Ø 55 mm, Height 11 mm
32	35-1155/13	Ø 55 mm, Height 13 mm
33	35-1158/07	Ø 58 mm, Height 7 mm
34	35-1158/09	Ø 58 mm, Height 9 mm
35	35-1158/11	Ø 58 mm, Height 11 mm
36	35-1158/13	Ø 58 mm, Height 13 mm
Tibial Trial Prostheses, for tibial plateaus (metal-backed)		
37	35-1045/08	Ø 45 mm, Height 8 mm
38	35-1045/09	Ø 45 mm, Height 9 mm
39	35-1045/11	Ø 45 mm, Height 11 mm
40	35-1045/13	Ø 45 mm, Height 13 mm
41	35-1050/08	Ø 50 mm, Height 8 mm
42	35-1050/09	Ø 50 mm, Height 9 mm
43	35-1050/11	Ø 50 mm, Height 11 mm
44	35-1050/13	Ø 50 mm, Height 13 mm
45	35-1055/08	Ø 55 mm, Height 8 mm
46	35-1055/09	Ø 55 mm, Height 9 mm
47	35-1055/11	Ø 55 mm, Height 11 mm
48	35-1055/13	Ø 55 mm, Height 13 mm
Tibial Templates, for tibial plateaus (metal-backed)		
49	35-1055/00	Ø 55 mm
50	35-1050/00	Ø 50 mm
51	35-1045/00	Ø 45 mm
52	35-1012/00	Keel Chisel, for tibial plateaus (metal-backed)

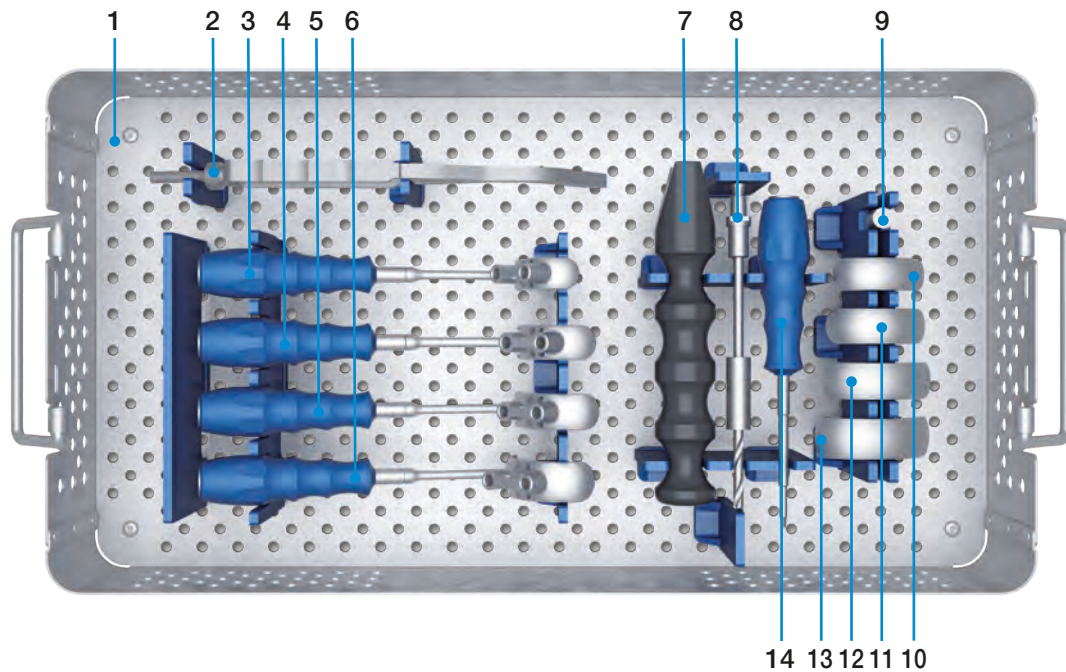

35-2100/00 Case – Femur Preparation



1	35-0201/00	Instruments Tray – Femur Preparation , empty, 485 x 253 x 80 mm
2	15-2201/10	Inserting Forceps , for trial sled prostheses
		Drill Guides
3	15-2040/40	small
4	15-2040/46	medium-small
5	15-2040/52	medium
6	15-2040/60	large
7	35-2002/00	Femoral Impactor
8	15-2040/03B	Twist Drill with stop, Ø 5.5 mm, 160 mm, with B Hudson fitting
9	15-2201/53	Fixation Pin for stabilization of drill guide
		Trial Sled Prostheses
10	35-2340/00	small
11	35-2346/00	medium-small
12	35-2352/00	medium
13	35-2360/00	large
14	319-535/00	Screwdriver , hex 2.5 mm

Adapter for Power Tool Chuck

Different adapters are available to ensure compatibility to allow various connections:

REF	Attachment
16-3283/01	Jakobs-Fitting (E) 
16-3284/00	AO-Fitting (D) 
16-3285/00	Harris-Fitting (C) 

Hudson-Fitting

Standard tool connection.

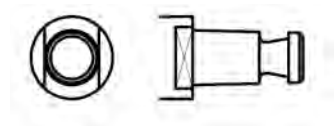

X-ray Templates, 110% actual size, one sheet

REF	Application
15-2021/10	for Unicondylar Sled Prosthesis 15-2020/40 to 15-2020/60
15-2021/14	for Tibial Plateaus, metal-backed 15-2030/02 to 15-2030/13 and 15-2230/02 to 15-2230/13
15-2021/13	for Tibial Plateaus, all-polyethylene 15-2028/01 to 15-2028/16

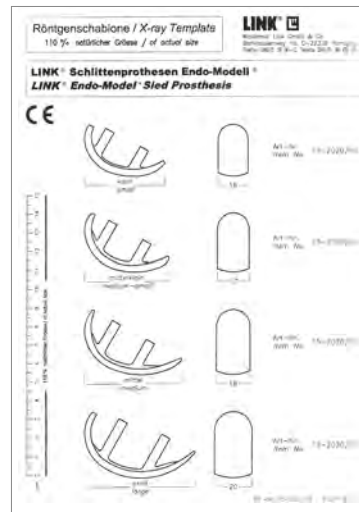

Further Information

LINK PorEx Technology
(TiNbN = Titanium-Niob-Nitride) Surface Modification
for metal sensitive patients

Important Information for X-ray Investigations

X-ray investigations

X-ray images can be used to evaluate implant positioning post-operatively. Images taken from certain angles can create the impression that the implant has broken.



Fig. 1: Post-operative X-ray 1



Fig. 2: Post-operative X-ray 2

Attention:

The LINK Tibial Plateau metal-backed is delivered as one piece, i.e. the Polyethylene Component and the Metal Component are pre-assembled as a single unit. The manufacturing process of the components has never been changed. For secure connection the polyethylene engages with a mechanical coupling device.

These technical specifications can lead X-ray images taken from certain angles to appear distorted, which may give the impression that the Tibial Plateau is broken. Examples of such distorted images are shown below:



Fig. 3a: Photograph of externally rotated tibia

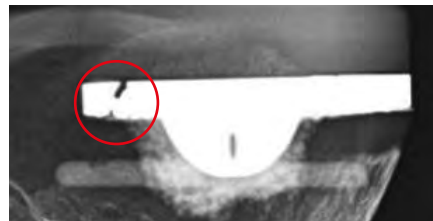

Fig. 3b: X-ray image of figure 3a

As a broken Tibial Plateau is most unlikely, the diagnosis should be verified with additional X-ray images.

Verification: Rotation of the tibia ensuring strictly lateral alignment for the follow-up X-ray.



Fig. 4a: Photograph of tibia from a strictly lateral position

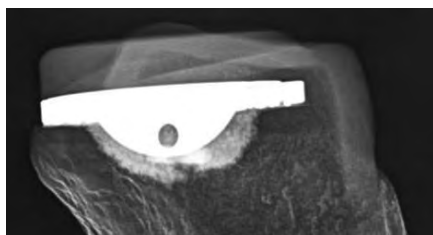

Fig. 4b: X-ray image of figure 4a

Specified indications and contraindications:	LINK Sled	LINK Sled with PorEx*
General Indications:		
Unicompartmental cartilage defect with limitation of mobility due to degeneration or post-traumatic arthrosis/arthritis.	X	X
Unicompartmental arthrosis in a stable knee (intact ligaments including anterior and posterior cruciate ligaments) with a correctable varus / valgus deformity (<10°).	X	X
Contraindications (absolute):		
Acute / chronic infections, local or systemic – insofar as they compromise the successful implantation of a unicondylar Sled prosthesis.	X	X
Any neuro-muscular disease affecting the limb which would put an arthroplasty 'at risk'.	X	X
Insufficient / inadequate bone stock preventing stable fixation of either prosthesis.	X	X
Unstable knee (Insufficient crucial and/or collateral ligaments).	X	X
Non-compliant patient.	X	X
Contraindications (relative):		
Hypersensitivity to (implant) materials (LINK PorEx indication).	X	-

* LINK PorEx: TiNbN = Titanium Niobium Nitride; hypoallergenic coating (gold colour).

Please note the following regarding the use of our implants:

1. Choosing the right implant is very important.

The size and shape of the human bone determines the size and shape of the implant and also limits the load capacity. Implants are not designed to withstand unlimited physical stress. Demands should not exceed normal functional loads.

2. Correct handling of the implant is very important.

Under no circumstances should the shape of a finished implant be altered, as this shortens its life span. Our implants must not be combined with implants from other manufacturers. The instruments indicated in the Surgical Technique must be used to ensure safe implantation of the components.

3. Implants must not be reused.

Implants are supplied sterile and are intended for single use only. Used implants must not be used again.

4. After-treatment is also very important.

The patient must be informed of the limitations of the implant. The load capacity of an implant cannot compare with that of healthy bone!

5. Unless otherwise indicated, implants are supplied in sterile packaging.

Note the following conditions for storage of packaged implants:

- Avoid extreme or sudden changes in temperature.
- Sterile implants in their original, intact protective packaging may be stored in permanent buildings up until the "Use by" date indicated on the packaging.
- They must not be exposed to frost, dampness or direct sunlight, or mechanical damage.
- Implants may be stored in their original packaging for up to 5 years after the date of manufacture. The "Use by" date is indicated on the product label.
- Do not use an implant if the packaging is damaged.

6. Traceability is important.

Please use the documentation stickers provided to ensure traceability.

7. Further information on the material composition is available on request from the manufacturer.

Follow the instructions for use!

Waldemar Link GmbH & Co. KG, Hamburg

All content in this catalog, including text, pictures and data, is protected by law. Every instance of use, whether in part or in whole and which is not permitted by law, is subject to our prior consent. In particular, this applies to the reproduction, editing, translation, publishing, saving, processing, or passing on of content stored in databases or other electronic media and systems, in any manner or form. The information in the catalogs is solely intended to describe the products and does not constitute a guarantee.

The Surgical Technique described has been written to the best of our knowledge and belief, but it does not relieve the surgeon of his/her responsibility to duly consider the particularities of each individual case.

Products shown in this document may not be available in your country. The product availability is subject to the approval and/or registration regulations of the respective country. Please contact Waldemar Link GmbH & Co. KG if you have questions about the availability of LINK products in your country.

Waldemar Link GmbH & Co. KG and/or other corporate affiliated entities own, use or have applied for the following trademarks in many jurisdictions: LINK, BiMobile, SPII, Modell Lubinus, E-Dur, EndoDur, T.O.P. II, BetaCup, CombiCup PF, CombiCup SC, CombiCup R, MobileLink, C.F.P., LCU, SP-CL, LCP, MIT-H, Endo-Model, Endo-Model SL, MP, MEGASYSTEM-C, GEMINI SL, SPAR-K, LCK, Link OptiStem, HX, TiCaP, X-LINKed, PorAg, LINK PorEx, BiPorEx, PorEx-Z, TrabecuLink, Tilastan, customLINK, RescueSleeve, Stactip, VACUCAST.

Other trademarks and trade names may be used in this document to refer to either the entities claiming the marks and/or names or their products and are the property of their respective owners.

 Waldemar Link GmbH & Co. KG

Barkhausenweg 10 · 22339 Hamburg · Germany
Phone +49 40 53995-0 · info@link-ortho.com
www.link-ortho.com

