







# LINK SLED Prosthesis

with MITUS Instrument Set

CE 0482

| Explanation of Pictograms   |                 |   |  |
|---|-----------------|---|--|
|  | Manufacturer    |  | Article number   |
|  | Material number |  | Product meets the applicable requirements, which are regulated in the EU harmonization legislation for the affixing of the CE marking. |

# LINK SLED Prosthesis with MITUS Instrument Set

## **Surgical Technique**

- 02 Patient Selection and Surgical Planning
- 03 Patient Positioning and Surgical Approach
- 04 Patient Positioning
- 05 Tibial Resection
- 12 Femoral Resection
- 14 Trial Reduction
- 18 Cementation

## **Implants**

- 20 Femoral Components
- 20 Tibial Plateaus – all-polyethylene
- 21 Tibial Plateaus – metal-backed

## **Instruments**

- 22 MITUS Instrument Set
- 26 Additional Instruments
- 27 Tibial Saw Guide
- 28 Additional Instruments
- 29 Accessories: Adapter, Sawblades, X-Ray Templates, Further Information
- 30 Important Information for X-ray Investigations
- 31 Indications/Contraindications
- Important Information

## Patient Selection and Surgical Planning

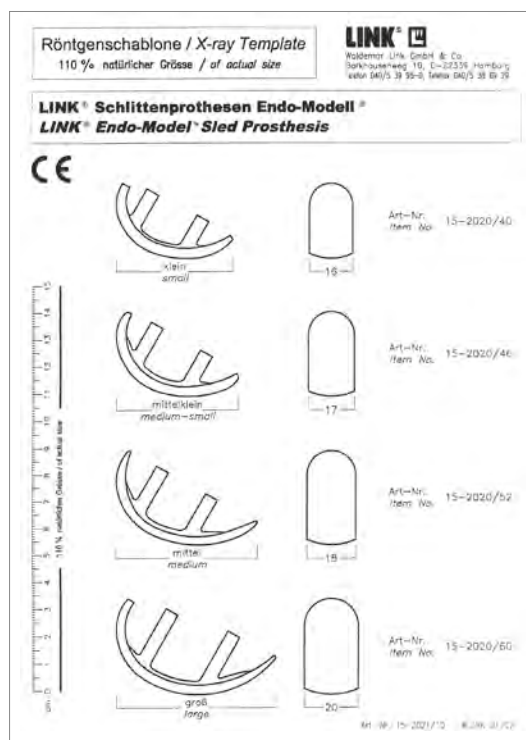

### Imaging:

Pre-operative planning is an essential part of the surgery.

The following baseline radiographs are recommended; Weight bearing AP views or Rosenberg PA view taken in slight flexion are essential. These may be supplemented by varus/valgus stress views and Rosenberg view to ensure a correctable deformity. True lateral (femoral condyles overlapping) to assess for posterior tibial plateau erosion seen with chronic ACL deficiency. Skyline PFJ view.

X-ray Templates of the individual components (femur and tibia) which are 110% the actual size are available. A note should be made of the natural tibial slope which will act as a guide during the tibial resection. These views may be supplemented by a long leg X-ray to determine the pre-operative weight bearing axis and any extra-articular deformity. We also support electronic computerized planning and cooperate with the leading manufacturers of electronic templating systems. We would be pleased to provide you with more information on request.

## Patient Positioning

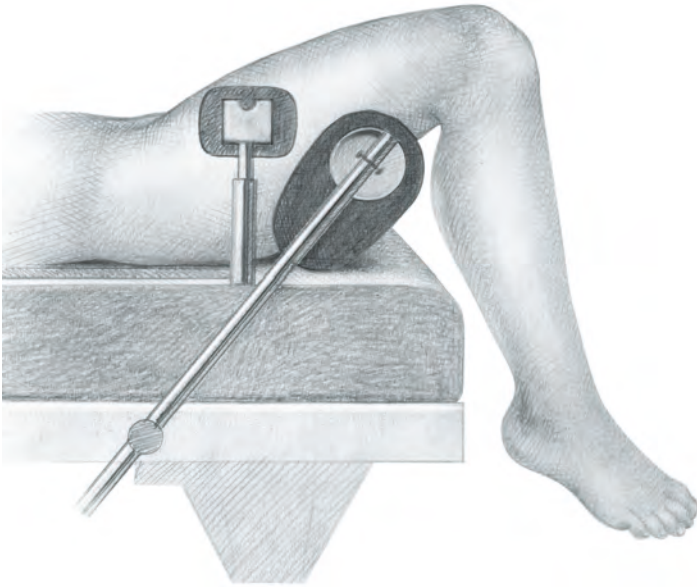

The limb is placed in a thigh support with 45° flexion of the hip. The leg is hanging down. It should be possible to flex the knee at least 120°. When using a medial incision a lateral thigh support is needed.

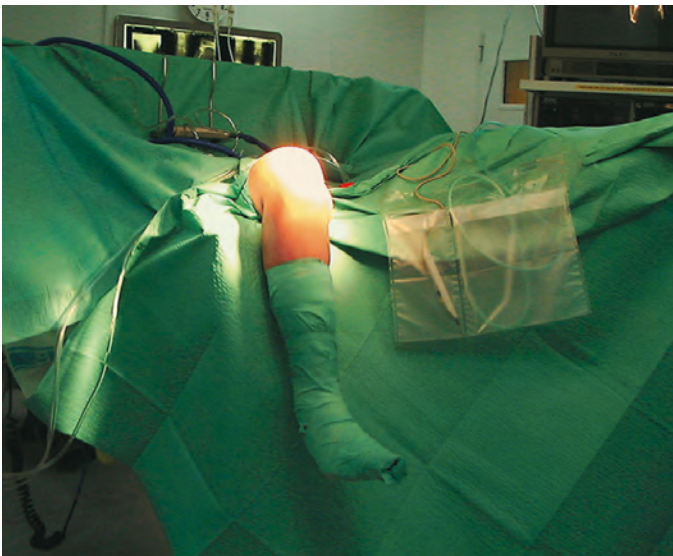

The operation is performed with the surgeon sitting in front of the flexed knee. The other leg is placed in a leg support leaving plenty of space for the surgeon and the assistant. The operation is performed in a bloodless field.

## Patient Positioning

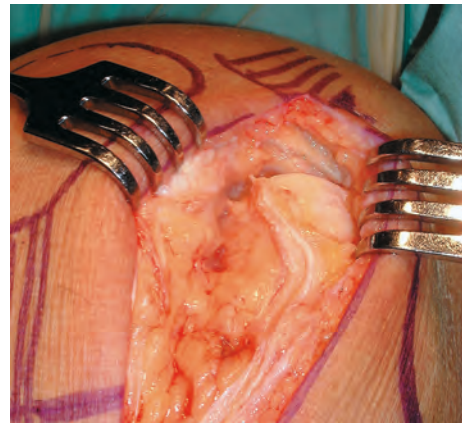
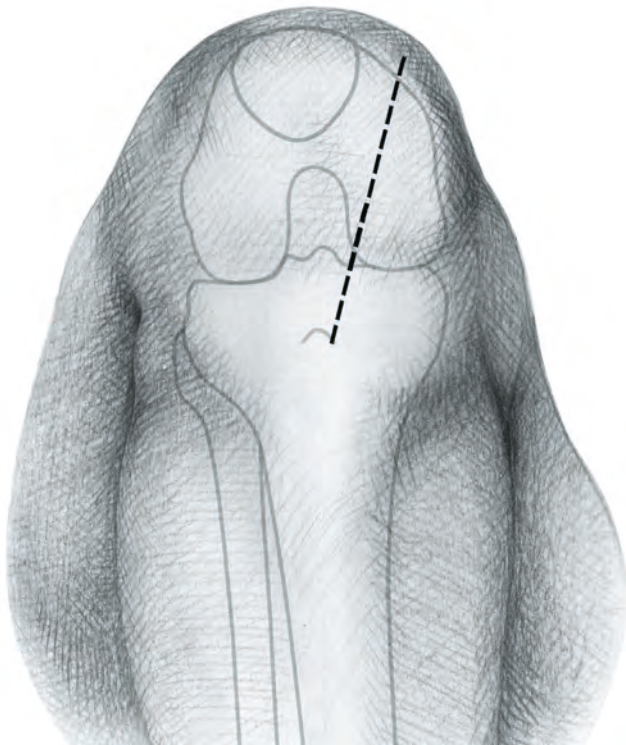

With the knee flexed 90°, a medial parapatellar incision is made starting at the margin of the vastus medialis 2–3 cm medial to the patella and extending distally and diagonally to the tibial tuberosity.

A medial parapatellar capsule incision is made. For better visualization the incision is angulated in its proximal part. The vastus medialis is detached. The capsule is released from the tibia almost to the front of the medial collateral ligament. The meniscus is removed. Partial excision of the retropatellar fat pad is necessary to gain better exposure of the intercondylar notch.

A retractor is placed in the lateral recess, allowing inspection of this compartment. To examine the patellar articulation, the knee is extended. If there are any doubts preoperatively about the condition of the other compartments diagnostic arthroscopy or MRI can be performed prior to the operation. After inspection, the retractor is placed in the intercondylar notch and the curved retractor behind the femoral condyle, to get a full view of the medial compartment.



## Tibial Resection



The purpose of the LINK Unicdylar Sled Prosthesis is to restore the damaged joint surfaces and the mechanical axis; a slight under-correction is desirable.

The Tibial Saw Guide allows the surgeon to determine and achieve the desired cutting depth precisely and to control the cutting in the frontal and the sagittal planes. The Saw Guide can be used with either a minimally invasive technique or the traditional exposure.

## Tibial Resection

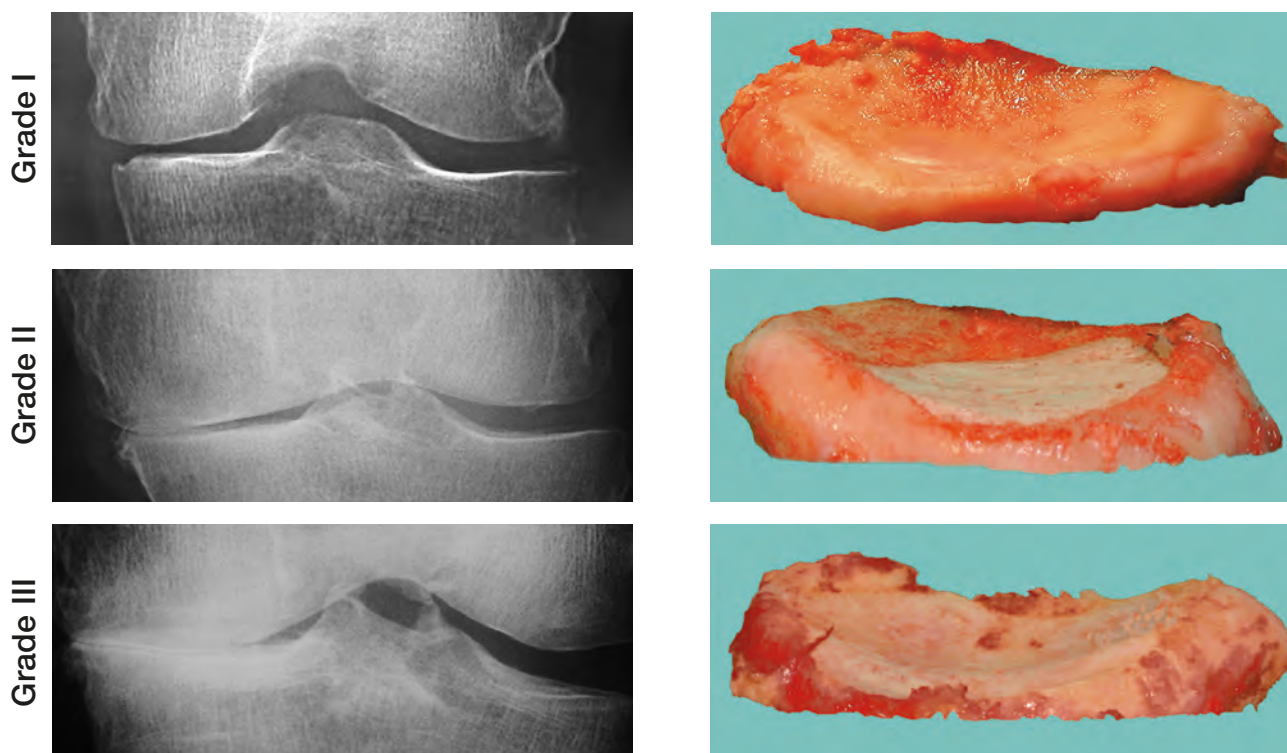

In knee replacement surgery by the traditional technique, the deepest point and the most damaged area of the tibial plateau are taken as the basis for determining the depth of the tibial resection. The depth of the resection is then highly dependent on the surgeon's experience. Often further resection is needed or the height of the Tibial Plateau must be changed to obtain the desired alignment and stability of the knee. The best aid to determining the depth of the horizontal cut is weight-bearing radiographs of the knee and pre-operative observations of the degree of cartilage damage. These allow a slight undercorrection of only a few degrees of varus to be achieved. The analysis of the weight-bearing radiographs is based on the classification of Ahlbäck.

The proposed resection depths are based on the use of a 9-mm high Tibial Plateau.

**Grade I** The joint space is reduced by one-half. The cartilage of the tibial condyle is preserved but reduced in height. The Cutting Platform should be adjusted to 11 mm depth. The stylus is placed at the deepest point of the remaining cartilage of the tibial condyle.

**Grade II** Total loss of the cartilage on both the femoral and the tibial condyles. The Cutting Platform should be adjusted to 9 mm depth and the stylus placed at the deepest point of the exposed bone of the tibial condyle.

**Grade III** Half a centimeter bone attrition of the femoral and tibial condyles on the frontal view weightbearing radiograph. The Cutting Platform should be adjusted to 7 mm and the stylus placed at the border between the exposed and the eroded bone.

The stylus is not placed at the level of the planned surface of the Tibial Plateau. In Grade I the surface of the Tibial Plateau will be lower than the surface of the tibial condyle, and correspondingly in Grade III the surface of the Tibial Plateau will be higher than the surface of the damaged tibial condyle.



## Tibial Resection

| Height of Tibial Plateaus | Resection Height |          |           |
|---------------------------|------------------|----------|-----------|
|                           | Grade I          | Grade II | Grade III |
| 7 mm                      | 9                | 7        | –         |
| 9 mm                      | 11               | 9        | 8         |
| 11 mm                     | 13               | 11       | 9         |

**Table 1:**

Depth of the tibial resection (mm) in relation to the chosen height of the Tibial Plateau.

| Resection Height | Height of Tibial Plateaus |          |           |
|------------------|---------------------------|----------|-----------|
|                  | Grade I                   | Grade II | Grade III |
| 7 mm             | –                         | 7        | 9         |
| 9 mm             | 7                         | 9        | 11        |
| 11 mm            | 9                         | 11       | 13        |

**Table 2:**

Height of the Tibial Plateau (mm) in relation to the depth of the tibial cutting.

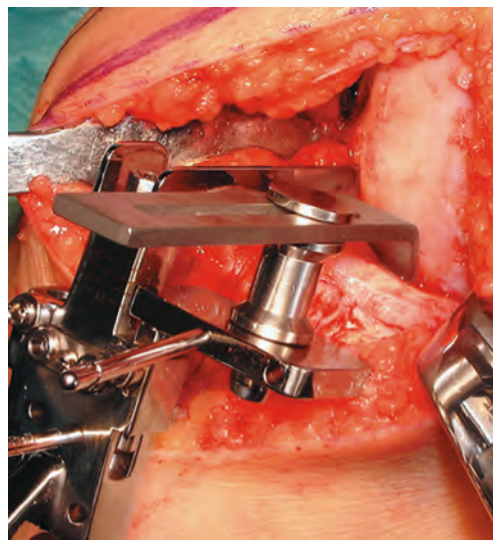

**Table 1**

When a 7-mm high Tibial Plateau is used, the tibial resection depth should be 9 mm in Grade I knees and 7 mm in Grade II knees. Because the construction of the Tibial Saw Guide does not permit less than 7 mm resection depth between the tip of the stylus and the Cutting Platform a 7-mm Tibial Plateau cannot be used in Grade III osteoarthrosis, and such knees must therefore be undercorrected. According to suggestions given above, the depth of the resection when using an 11-mm Tibial Plateau will be 13 mm in Grade I, 11 mm in Grade II, and 9 mm in Grade III. These resection depths will unnecessarily be too deep and will remove more bone than necessary.

**Table 2**

It is convenient to use the same resection depth independent of the degree of cartilage and bone damage. This means that a resection depth of 9 mm in relation to the tibial surface is needed in order to use a 7-mm Tibial Plateau in Grade I, a 9-mm Tibial Plateau in Grade II and an 11-mm Tibial Plateau in Grade III to achieve the same degree of alignment.

## Tibial Resection

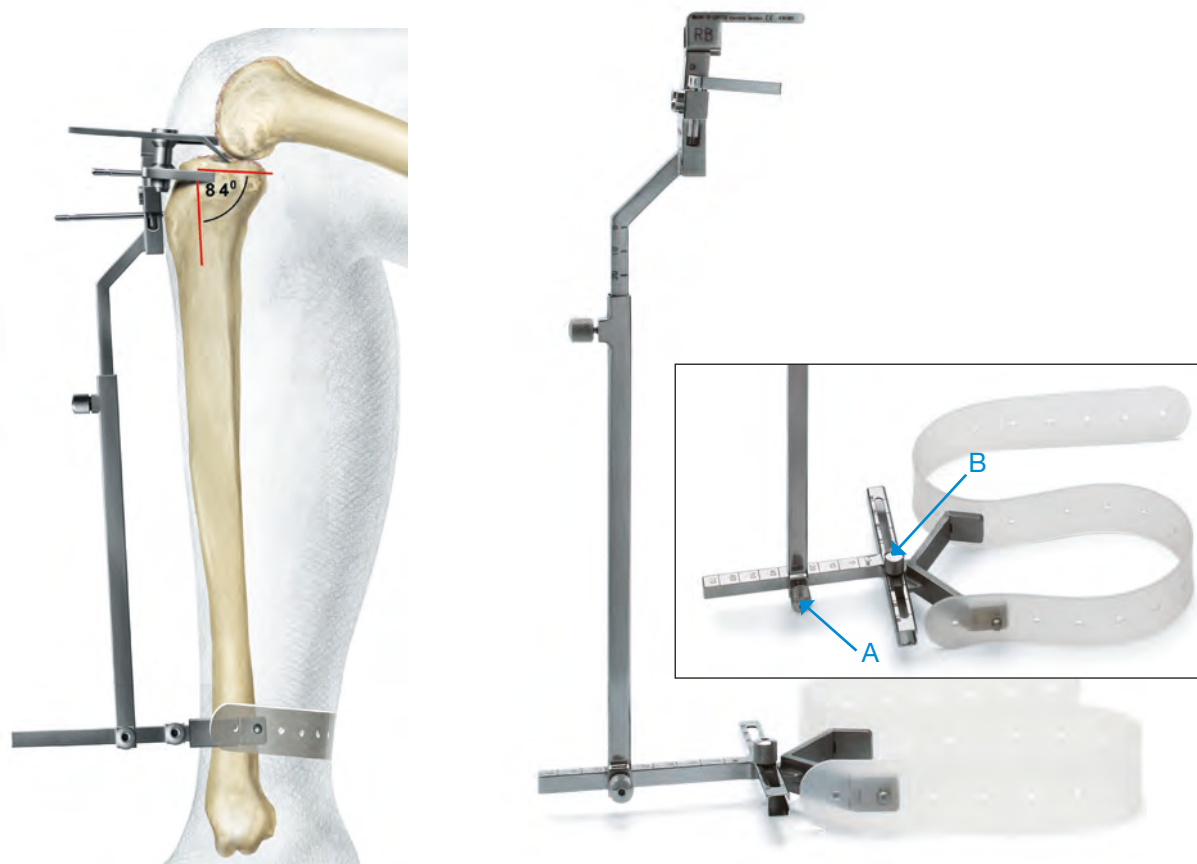

The clamp of the Tibial Saw Guide is placed at the level of the ankle directly proximal to the malleoli.

### The posterior slope of the Tibial Component

Orientation of the posterior slope to the natural preoperative situation, so that the biomechanics of the individual patient are not changed.

The resection can be checked for control purposes. It should have the same thickness ventral-dorsal parallel. Note that the Cutting Platform has a posterior slope of 6° in relation to the long axis of the Guide. The Tibial Saw Guide should be adjusted in the vertical plane parallel to the long axis of tibia by moving the vertical rod ventrally. In most cases the Guide needs to be moved 20–25 mm anteriorly to obtain the required posterior angle of a 6°. **Lock Screw A.**

Orientation of the posterior slope to the natural preoperative situation, so that the biomechanics of the individual patient are not changed.

The resection can be checked for control purposes. It should have the same thickness ventral-dorsal parallel.

**Attention:** Kinematic results suggested that 5° to 7° of posterior slope were preferable, and that excessive posterior slope (> 7°) should be avoided.

### The varus-valgus alignment of the Tibial Component

The varus-valgus alignment of the Tibial Component can be adjusted by placing the distal fixation of the long rod beneath the actual tibia condyle. In women the rod is moved approximately 20–25 mm and in men 25–30 mm from the center to achieve a cutting surface perpendicular to the long axis of tibia. The varus-valgus alignment is controlled with the Alignment Rod. **Lock Screw B.**

**Warning:** Overcorrection in valgus should be avoided under all circumstances. Position the tibia in 0° to 3° varus. Place the Alignment Rod through the Tibial Cutting Block

## Tibial Resection

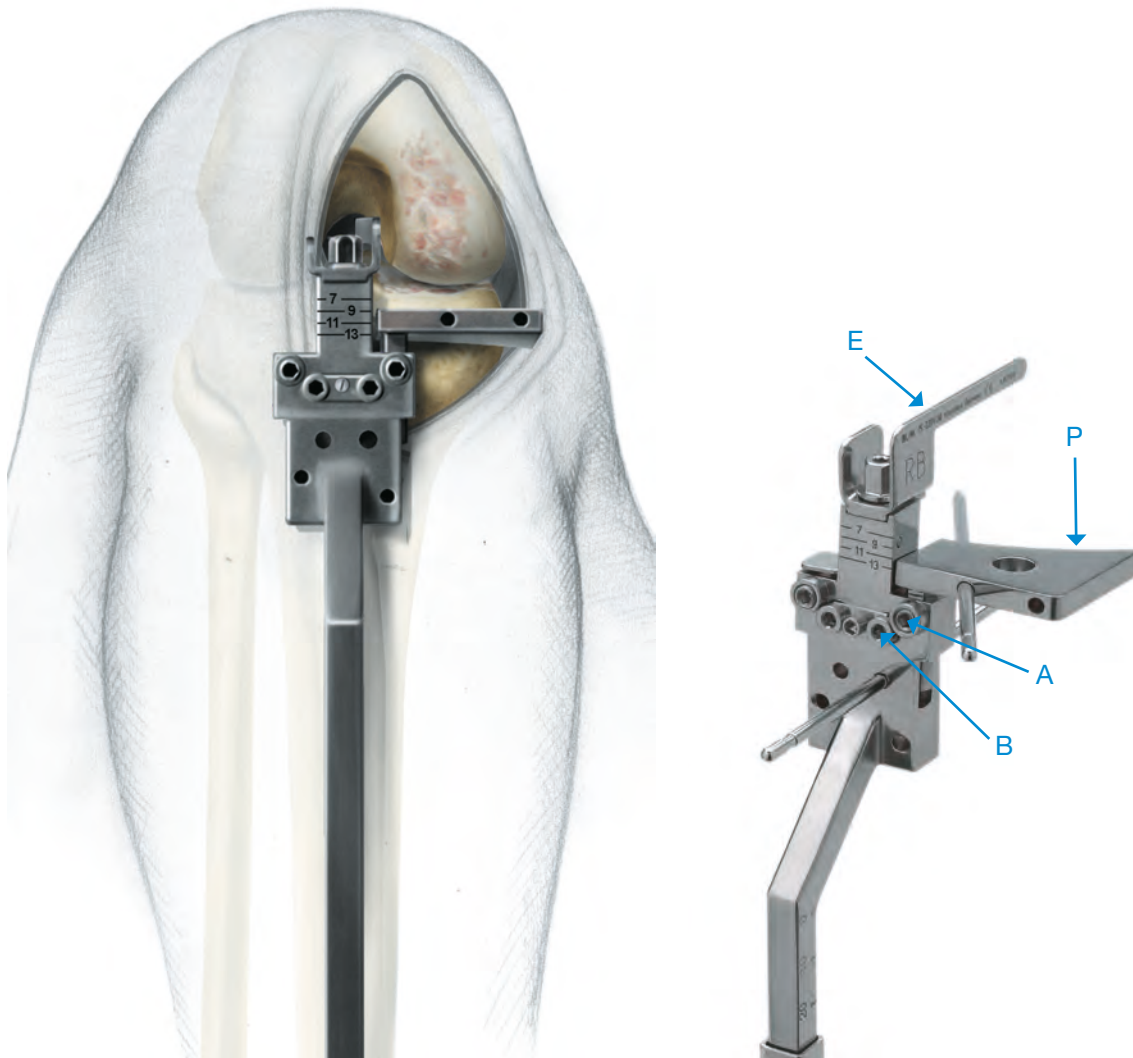

The **Eminentia Saw Guide (E)** is placed close and parallel to the eminentia along the planned sagittal cut.

**Attention:** The eminentia intercondylaris and in particular the insertion of the anterior cruciate ligament serve for orientation. The sagittal cut should be made just medial to the ACL attachment point on the tibial spine in order to **maximize the size of the tibial base**.

There are **Cutting Platforms (P)** for the medial as well as the lateral compartments. The cutting depth can be set between 7 and 13 mm by using a Screwdriver in the adjustment **Hole (B)**. The Cutting Platform is secured and locked with **Screw (A)**.

The **Tibial Saw Guide** is fixed with a Fixation Pin in the central hole of the platform. The Pin is angulated centrally towards the eminentia. A second Fixation Pin is placed in the Tibial Saw Guide to secure the position.

## Tibial Resection

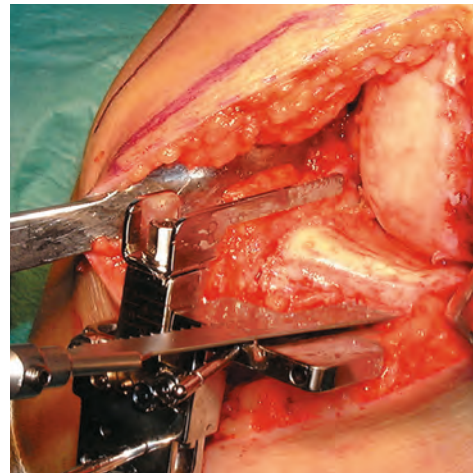
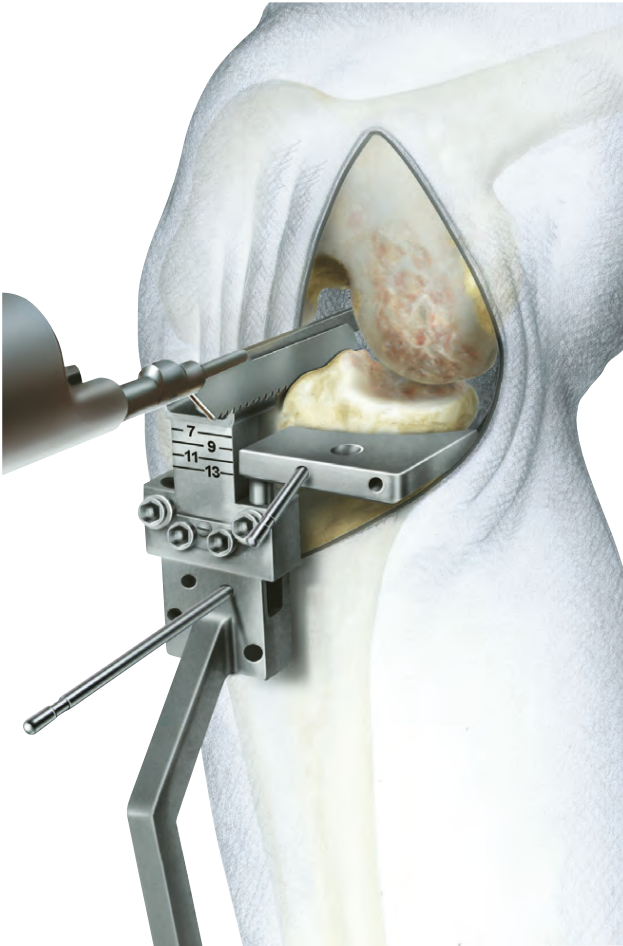

### Bone Cuts

The **vertical cut** is performed along the Eminentia Saw Guide. The **horizontal cut** is guided by the Cutting Platform.

The resected Tibial Plateau and remaining parts of the meniscus are then removed.

Tibial Resection

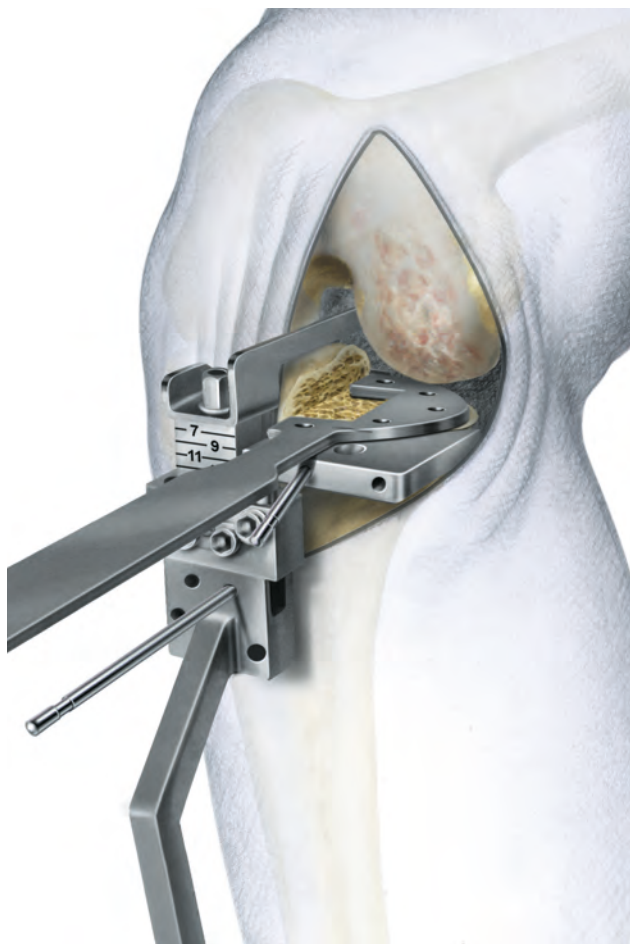

Templates for Tibial Plateaus all-Polyethylene (3 sizes: 45, 50, 55 mm)



Templates for Tibial Plateaus metal-backed (3 sizes: 45, 50, 55 mm)

Depending on implant selection a **Template** is used for the sizing of the Tibial Plateau. Both are available in three sizes (45, 50 and 55 mm).

The size of the Tibial Plateau in the sagittal plane is determined by placing the hook of the Template behind the tibial condyle. If the anterior part of the Template is in alignment with the anterior border of the tibia, that is the right size.

The size must be checked medially to ensure there is no medial overhang.

**Attention:** It is important to achieve maximal coverage of the tibial plateau. Determine the tibial component as large as possible. However, an overhang, especially anteriorly, should be avoided.



## Femoral Resection

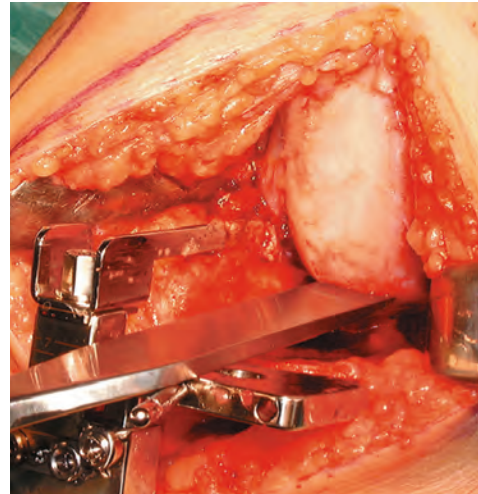
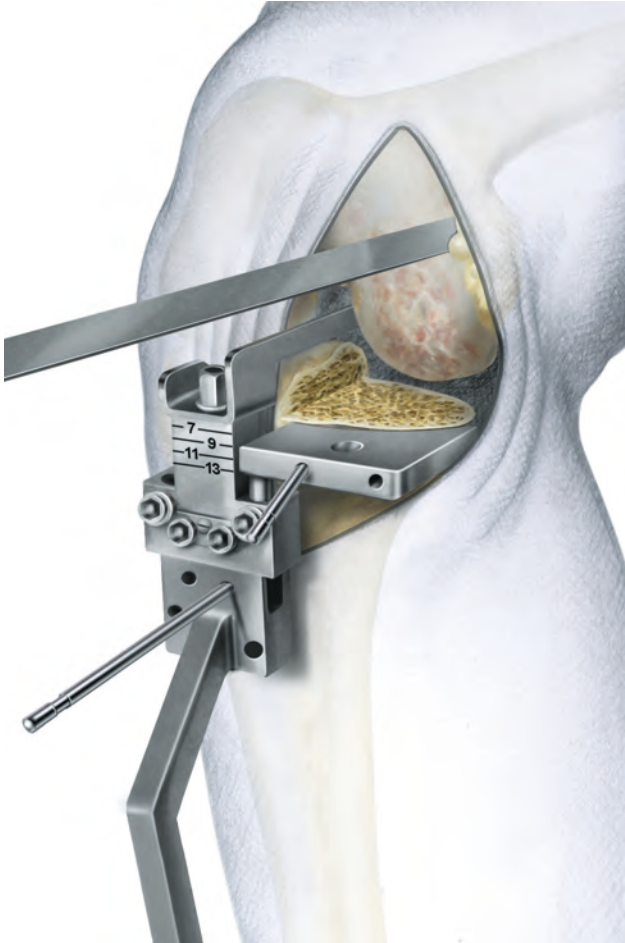

**Do not remove the Tibial Saw Guide** during the preparation for the Femoral Component.

Begin the preparation of the femoral condyle by cutting 3–5 mm of its posterior aspect to remove undamaged cartilage.

Resect central and medial osteophytes, with attention to osteophytes behind the medial collateral ligament.

## Femoral Resection

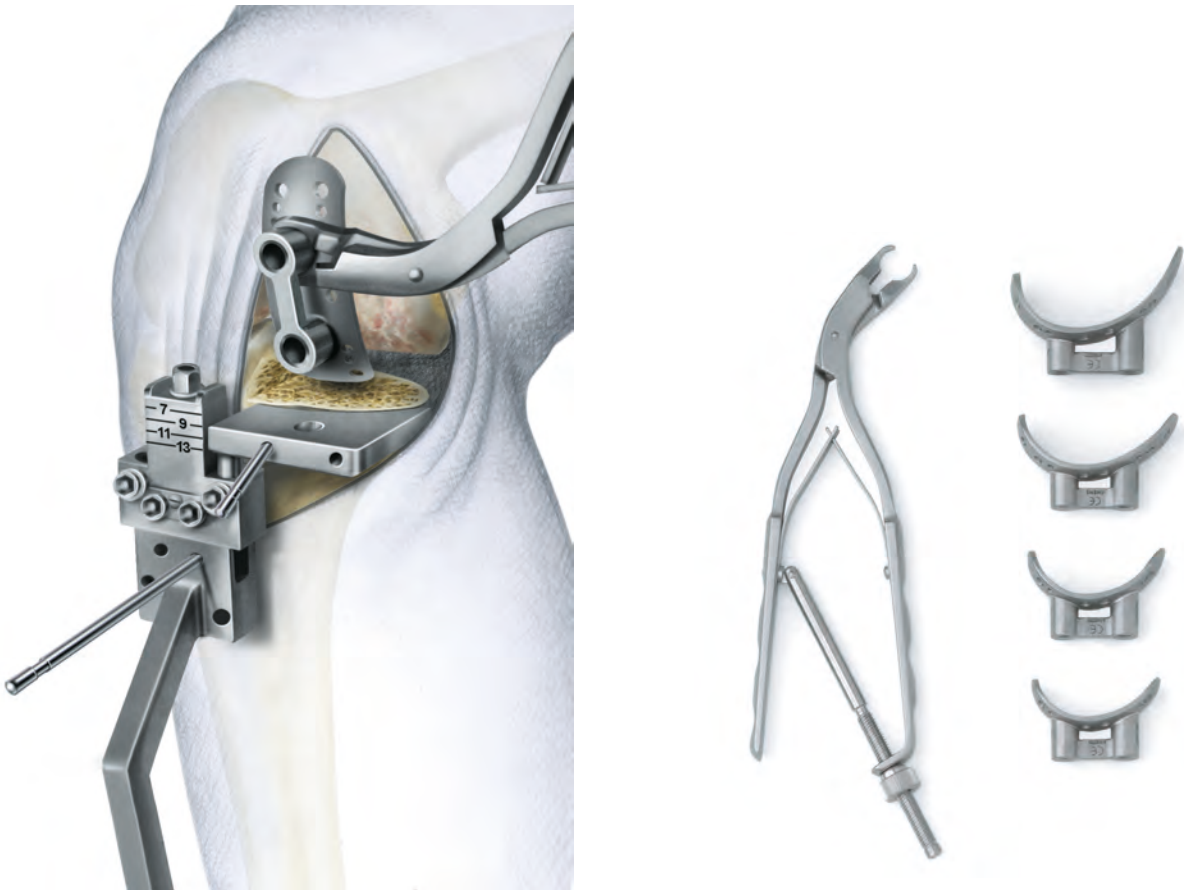

There are four sizes of the Femoral Components (40, 46, 52 and 60 mm) and corresponding Drill Guides to determine the correct size. The selected femoral Drill Guide is placed centrally on the femoral condyle and fixed with two short Fixation Pins.

## Trial Reduction



Drill the anchoring holes. If it is difficult to drill the lower hole at 100-110° of flexion of the knee, the Femoral Drill Guide is either too large or has been placed too far dorsally. Either change its position or chose a smaller Drill Guide.

Mark the borders of the Drill Guide. Remove any cartilage inside the area marked for the Femoral Component.

Trial Reduction

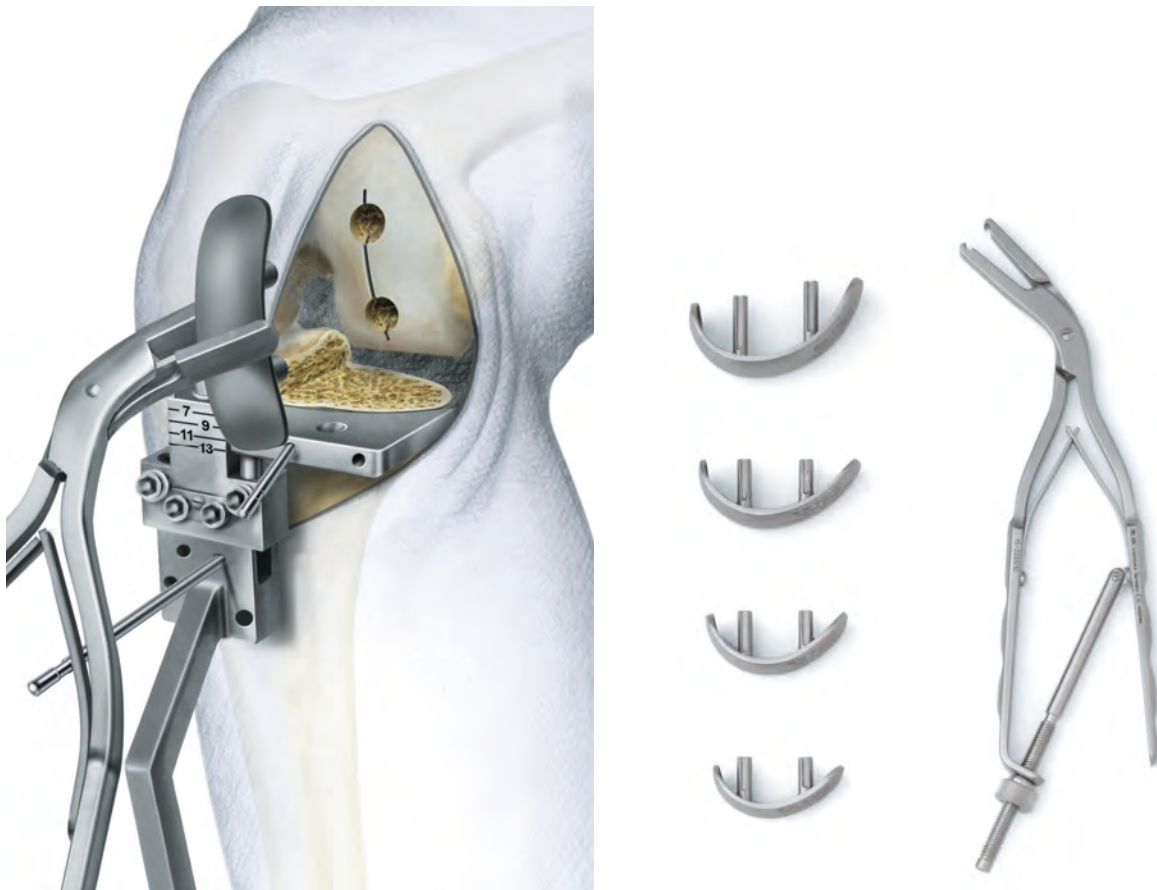

Corresponding to the Femoral Drill Guides are four **Femoral Trial Sled Prostheses**. Before trialing the chosen size, use a chisel or a saw to prepare a groove between the two anchoring holes. Place the Femoral Trial Sled Prosthesis using the **Inserting Forceps**.

**Attention:** The appropriate orientation for the pegs should be considered.



Test knee flexion and extension to make certain that the Femoral Trial Sled Prosthesis does not make contact with the patella at any point during the movement. If it does, remove that part of the patella that made the contact.

## Trial Reduction

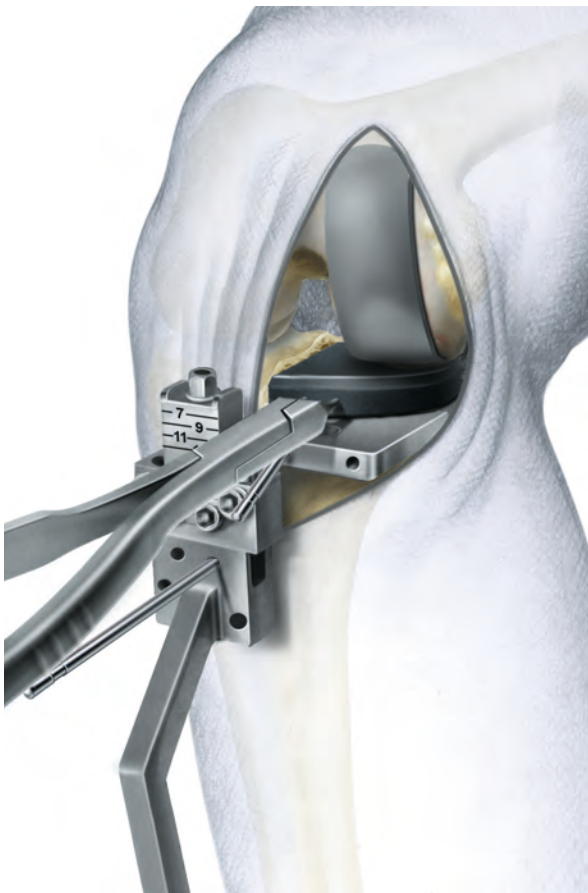

The **Tibial Plateaus** (all-polyethylene) are available in 4 heights (7, 9, 11 and 13 mm) and the Tibial Plateaus (metal-backed) in 3 heights (9, 11 and 13 mm).

With the Femoral Trial Sled Prosthesis in place, a 9-mm **Tibial Trial Plateau** is positioned. This is easiest when the knee is flexed at least 90°. Some valgus load may be needed. If the Tibial Component has a tendency to tilt anteriorly, the posterior angle of slope is too small. This can be corrected with a rasp.

The knee is moved through its entire range of motion to check joint stability. The height of the Tibial Component is to be selected so that the natural tension of the ligaments is restored. With valgus loading of the knee joint, it should be possible to open the medial joint space 1-2 mm.

**Warning:** Overcorrection in valgus should be avoided under all circumstances. Position the tibia in 0° to 3° varus. It is important to ensure a slight under correction of the limb alignment and have appropriate ligamentous tension restored (2-3 mm of laxity) in flexion and extension.



## Trial Reduction

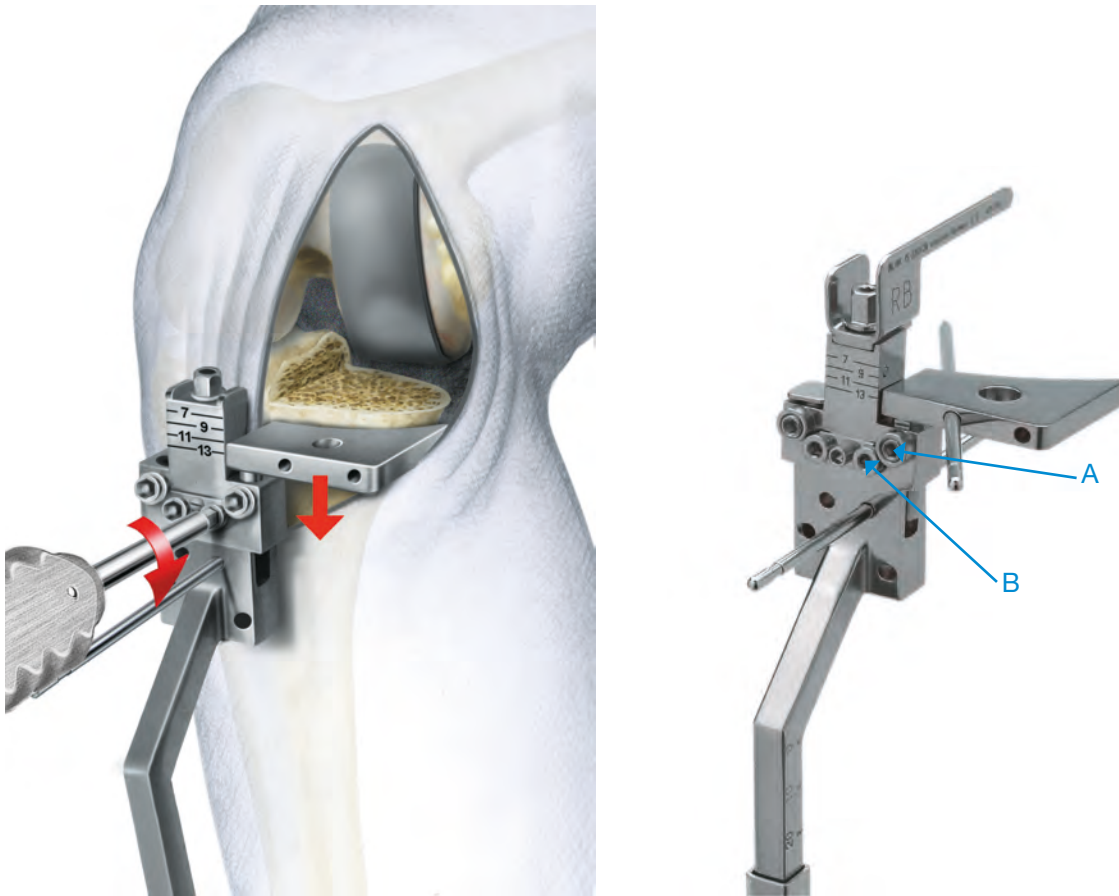

If the knee is too tight, remove the Tibial Trial Component and the Fixation Pin in the Cutting Platform and loosen **Screw (A)**. Deepen the resection by lowering the platform to the appropriate level by turning **Screw (B)** using a Screwdriver. As a rule 1-mm increase in resection depth increases varus angulation by 2 degrees.

Secure the Cutting Platform by tightening **Screw (A)** and stabilize it with a Fixation Pin through one of the unused holes in the Cutting Platform.

Perform the cut and repeat the trial by using the same height of the Tibial Trial Component.

### Cementation

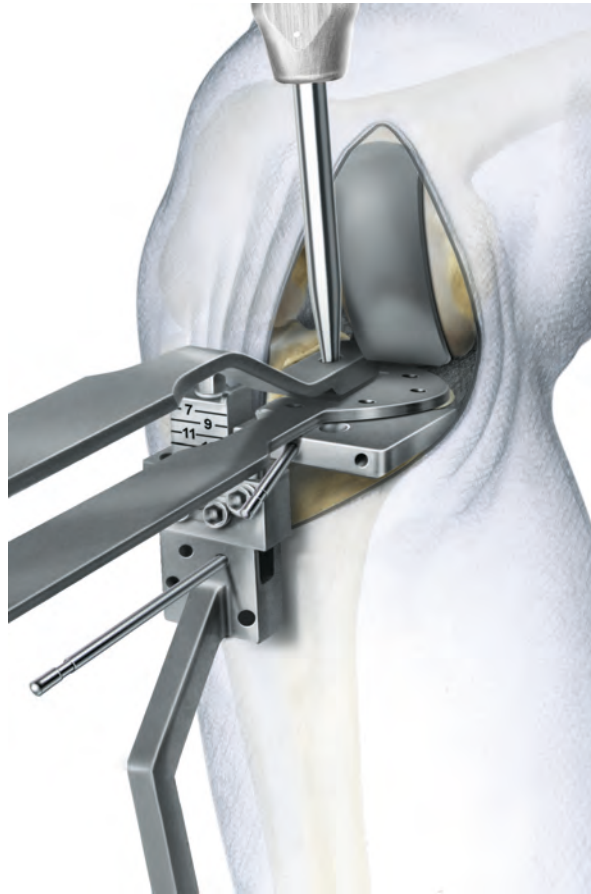

Prepare the space for the keel of the Tibial Plateau (metal-backed), place the head of the **Cancellous Bone Compressor** into the recess of the tibial Template and impact it using the **Impactor**.

The keel of the Tibial Plateau (all-polyethylene) is larger. To prevent fractures of the tibial condyle remove some bone with a chisel before impacting the Bone Compressor.

Whichever Tibial Plateau is being used, the tibial surface needs to be protected during the compression of the bone with the tibial Template, which is laid on the sawing platform. Test that the final choice of Tibial Plateau fits and can be placed easily. Some valgus stress will be needed. The keel slot may be extended anteriorly if necessary.

## Cementation

### Preparation

#### Warning:

A good fixation of the implant components is a prerequisite to achieve long-term success of the application. Cementing technique is one of the factors that play an important role in this respect. Therefore the following instructions have to be carefully considered.

In sclerotic bone, multiple holes should be drilled with a small drill (Max diam 3.0 mm-drill pins can be used as an alternative) to ensure better bone cement interdigitation. Due to the preparation technique, this is particularly important for the femoral condyle. Cleanse all cement-receiving bone surfaces thoroughly using pulse lavage and dry with a clean, dry lap sponge.

#### General remarks

The tibial and femoral components should be done in two stages. This ensures that there is sufficient time to position the component, remove excess bone cement and allow it to harden without inadvertently manipulating the implant-bone cementbone interface.

The bone cement, which has been prepared according to the manufacturer's instructions, is applied both to the back of the implant and to the bone.

Beginning with the tibial component, the bone cement is carefully applied evenly to ensure a homogeneous cement mantle.

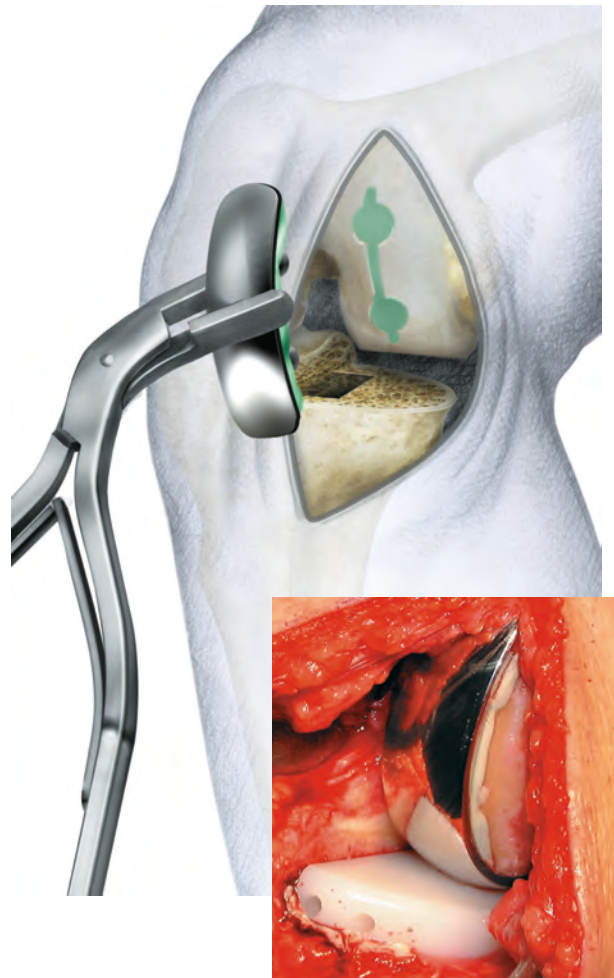

**Attention:** It should be considered to apply bone cement at the vertical wall a too.

A steady pressure is maintained with the tibial impactor during curing. The femoral component is then cemented.

**Option:** Start the implantation with the femoral component.

### Cementation of Tibial Component

Apply a thin layer of cement over the entire underside of the tibial component. The cement should just overfill the bead structure on the underside of the tray, up to 1 mm proud posteriorly and 2 mm proud anteriorly.

Apply cement to the tibia and pressurize the cement, striving for penetration of 3-4 mm.

Use of a cement gun/cartridge equipped with a pressurizing nozzle is recommended to deliver and pressurize cement into the prepared holes and across the flat surface.

Alternatively, cement may be applied manually and pressurized into the bone using a flat osteotome.

### Cementation of Femoral Component

The Bone Cement is applied to the back of the Femoral Component . In addition, both drill holes for the fixation pegs are filled with Bone Cement. The Femoral Component is positioned u sing Inserting Forceps and both pegs are to be inserted into the prepared drill holes.

The Femoral Component is then finally driven on using the Femoral Impactor

**Femoral Components**

**MAT** CoCrMo or CoCrMo/TiNbN

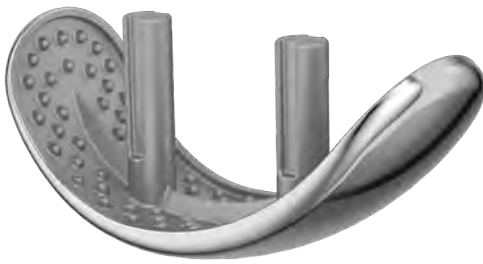

| REF CoCrMo | REF CoCrMo/<br>LINK PorEx* | Size         | Width<br>(K)<br>mm | Length<br>(T)<br>mm |
|------------|----------------------------|--------------|--------------------|---------------------|
| 15-2020/40 | 15-2220/40                 | small        | 16                 | 40                  |
| 15-2020/46 | 15-2220/46                 | medium small | 17                 | 46                  |
| 15-2020/52 | 15-2220/52                 | medium       | 18                 | 52                  |
| 15-2020/60 | 15-2220/60                 | large        | 20                 | 60                  |

\* LINK PorEx: TiNbN = Titanium Niobium Nitride; hypoallergenic coating (gold colour).

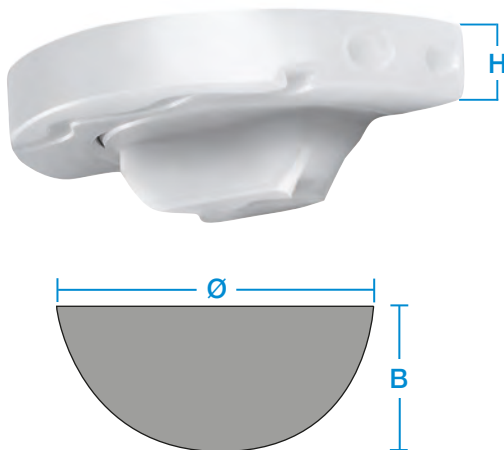
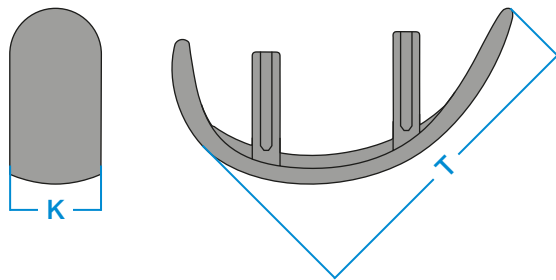

**Tibial Plateaus – All-polyethylene**

**MAT** UHMWPE/ CoCrNiMoFe

| REF UHMWPE/<br>CoCrNiMoFe | Height<br>(H)<br>mm | Ø<br>mm | Width<br>mm |
|---------------------------|---------------------|---------|-------------|
| 15-2028/01                | 7                   | 45      | 22          |
| 15-2028/02                | 9                   | 45      | 22          |
| 15-2028/03                | 11                  | 45      | 22          |
| 15-2028/04                | 13                  | 45      | 22          |
| 15-2028/05                | 7                   | 50      | 27          |
| 15-2028/06                | 9                   | 50      | 27          |
| 15-2028/07                | 11                  | 50      | 27          |
| 15-2028/08                | 13                  | 50      | 27          |
| 15-2028/09                | 7                   | 55      | 29          |
| 15-2028/10                | 9                   | 55      | 29          |
| 15-2028/11                | 11                  | 55      | 29          |
| 15-2028/12                | 13                  | 55      | 29          |
| 15-2028/13                | 7                   | 58      | 31          |
| 15-2028/14                | 9                   | 58      | 31          |
| 15-2028/15                | 11                  | 58      | 31          |
| 15-2028/16                | 13                  | 58      | 31          |

**Important information:**

Tibial Components of 7-mm high offer the advantage of particular bone preservation and allow for a good range of motion. The suitability of these particular components have to be medically indicated. The Tibial Components of 7-mm high are not suitable for obese or very active patients.

**Tibial Plateaus – metal-backed**

**MAT** CoCrMo or CoCrMo/TiNbN, UHMWPE

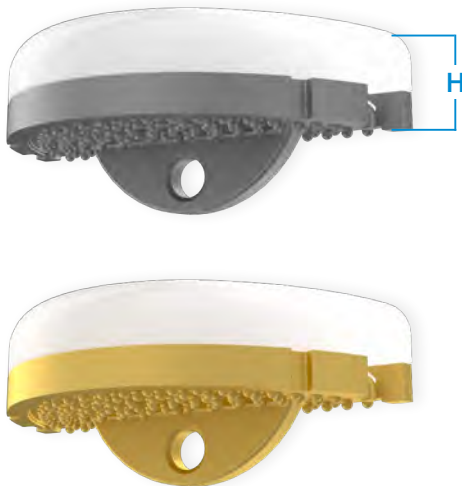

| REF CoCrMo | REF CoCrMo/<br>LINK PorEx* | Height<br>(H)<br>mm | Ø<br>mm | Width<br>(B)<br>mm |
|------------|----------------------------|---------------------|---------|--------------------|
| 15-2030/13 | 15-2230/13                 | 8                   | 45      | 22.5               |
| 15-2030/02 | 15-2230/02                 | 9                   | 45      | 22.5               |
| 15-2030/03 | 15-2230/03                 | 11                  | 45      | 22.5               |
| 15-2030/04 | 15-2230/04                 | 13                  | 45      | 22.5               |
| 15-2030/14 | 15-2230/14                 | 8                   | 50      | 25.0               |
| 15-2030/06 | 15-2230/06                 | 9                   | 50      | 25.0               |
| 15-2030/07 | 15-2230/07                 | 11                  | 50      | 25.0               |
| 15-2030/08 | 15-2230/08                 | 13                  | 50      | 25.0               |
| 15-2030/15 | 15-2230/15                 | 8                   | 55      | 27.5               |
| 15-2030/10 | 15-2230/10                 | 9                   | 55      | 27.5               |
| 15-2030/11 | 15-2230/11                 | 11                  | 55      | 27.5               |
| 15-2030/12 | 15-2230/12                 | 13                  | 55      | 27.5               |

\* LINK PorEx: TiNbN = Titanium Niobium Nitride; hypoallergenic coating (gold colour).

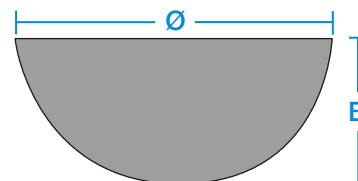



### MITUS Instrument Set

Minimally Invasive Surgical Technique for LINK Unicondylar Sled Prosthesis

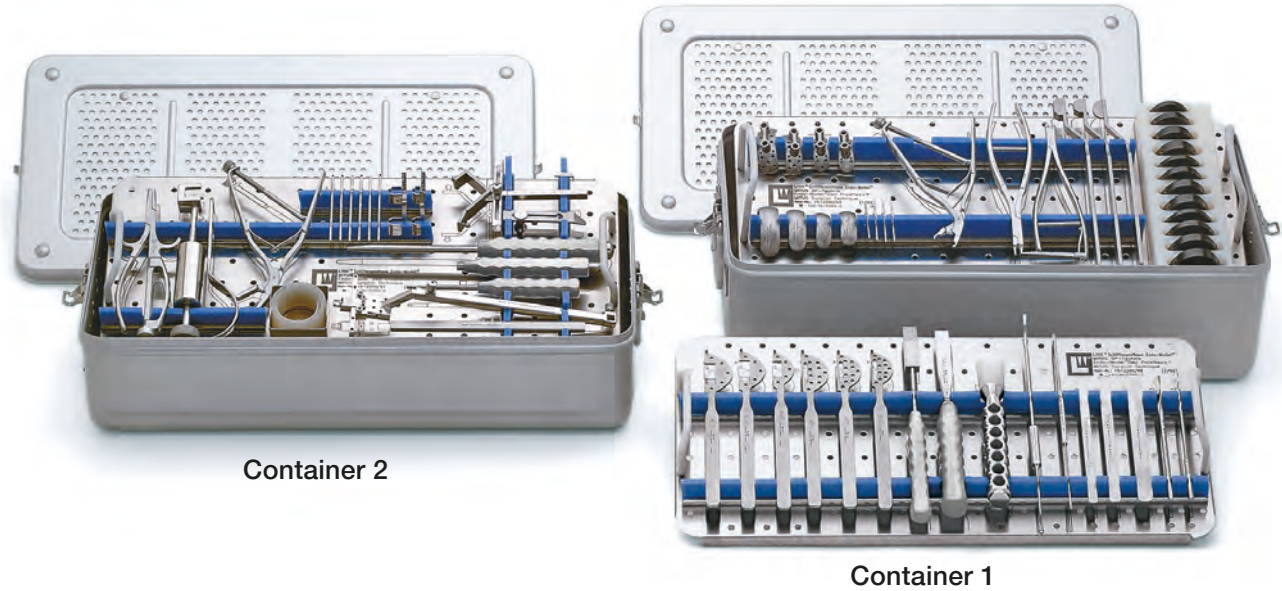

Container 2

Container 1

| REF        | Instrument Set, complete (Container 1 and 2)  |      |
|------------|---|------|
| 15-2201/01 | Set, complete in 2 standard containers, on 3 trays with storage inserts, consisting of: |      |
| 05-2001/03 | N11 Standard Container, empty, stainless steel, 575 x 275 x 100 mm                      | 1ea. |
| 05-2002/03 | N21 Standard Container, empty, stainless steel, 575 x 275 x 130 mm                      | 1ea. |
| 15-2200/02 | Lower Tray (Container 1), empty, perforated stainless steel, 550 x 265 x 50 mm          | 1ea. |
| 15-2200/03 | Upper Tray (Container 1), empty, perforated stainless steel, 550 x 265 x 50 mm          | 1ea. |
| 15-2200/01 | Tray (Container 2), empty, perforated stainless steel, 550 x 265 x 50 mm                | 1ea. |

\*Fittings: How to order: 317-649/08B = Hudson fitting

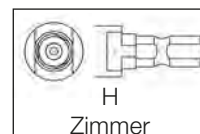
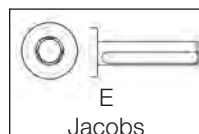
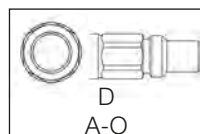
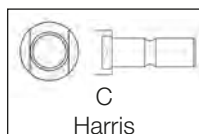
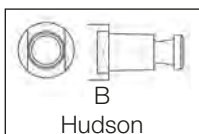

Lower Tray, Container 1

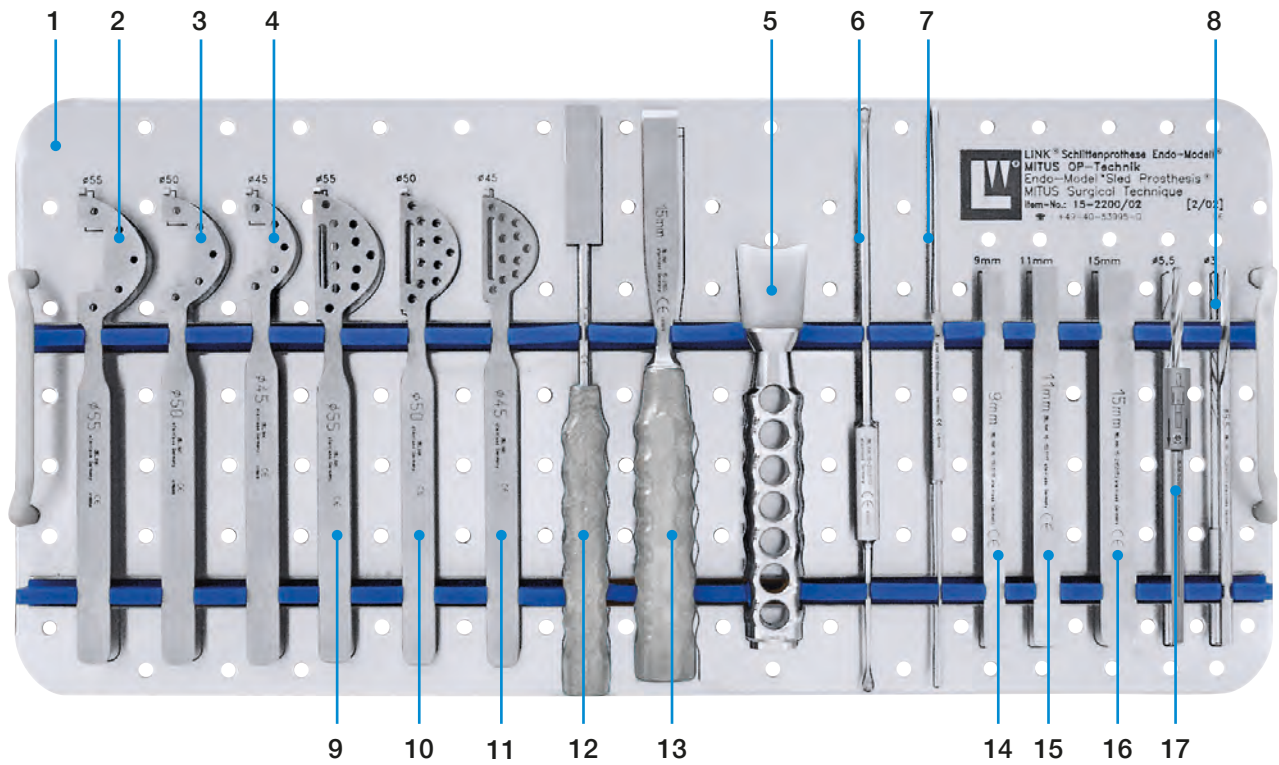

|   |              |  |
|---|--------------|--|
| 1   | 15-2200/02   | <b>Lower Tray (Container 1), empty, 550 x 265 x 50 mm</b>                        |
| <b>Drill and Saw Guide (templates) for tibial plateaus all-polyethylene</b> |              |  |
| 2   | 15-2201/55   | 55 mm  |
| 3   | 15-2201/50   | 50 mm  |
| 4   | 15-2201/45   | 45 mm  |
| 5   | 15-2040/05   | <b>Sled Impactor, for sled prosthesis metal-backed, 170 mm</b>                   |
| 6   | 15-2201/70   | <b>Curette, to remove excess cement</b>  |
| 7   | 15-2201/71   | <b>Spatula, double end, to remove excess cement</b>                              |
| 8   | 15-2040/03E* | <b>Twist Drill with stop, Ø 5.5 mm, 160 mm, fittings optional (see page 25)*</b> |
| <b>Drill and Saw Guide (templates) for tibial plateaus metal-backed</b>     |              |  |
| 9   | 15-2202/55   | 55 mm  |
| 10  | 15-2202/50   | 50 mm  |
| 11  | 15-2202/45   | 45 mm  |
| 12  | 15-2040/06   | <b>Plateau Impactor, 250 mm</b>  |
| 13  | 15-2105      | <b>Chip Chisel, 15 mm wide, 240 mm</b>   |
| 14  | 15-2201/16   | <b>Lambotte Osteotome, width 9 mm</b>  |
| 15  | 15-2201/17   | <b>Lambotte Osteotome, width 11 mm</b>   |
| 16  | 15-2102/03   | <b>Lambotte Osteotome, width 15 mm</b>   |
| 17  | 15-2040/02E* | <b>Twist Drill, Ø 3.0 mm, 160 mm, fittings optional (see page 24)*</b>           |

Upper Tray, Container 1

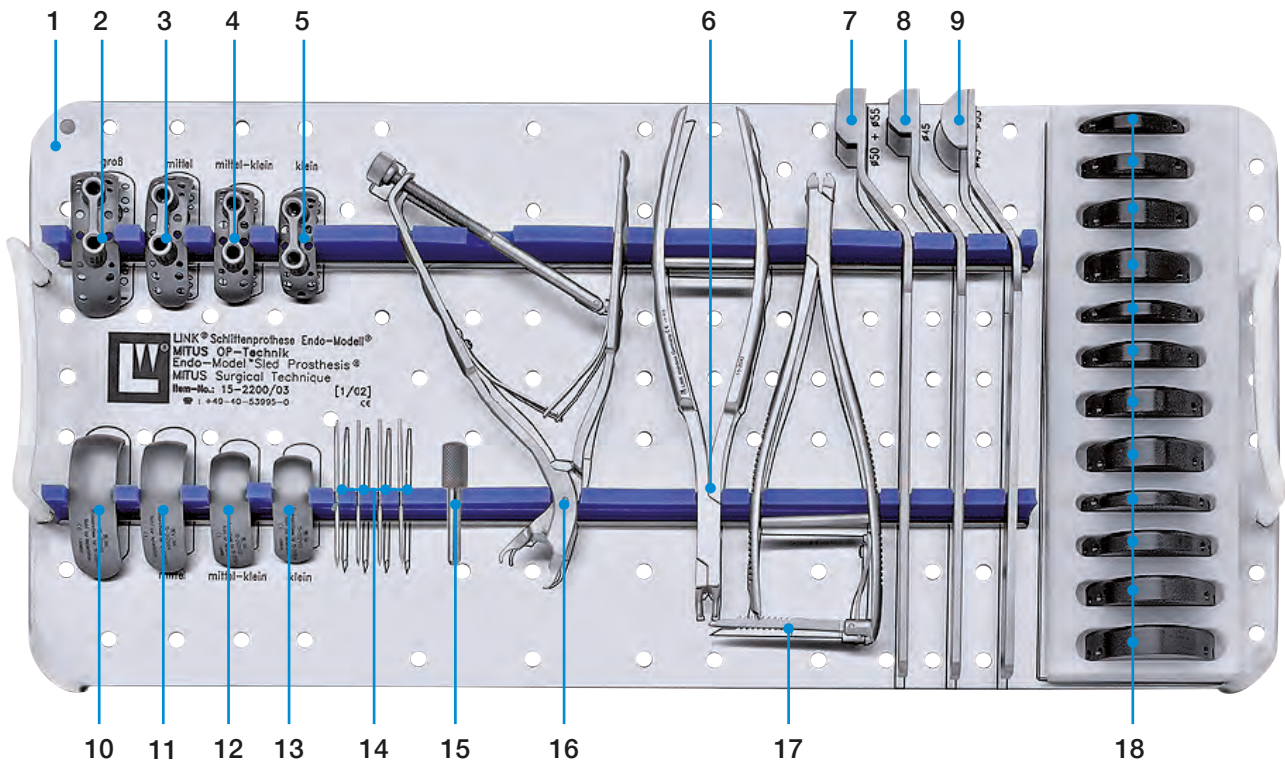

|   |            |  |
|---|------------|--|
| 1   | 15-2200/03 | Upper Tray (Container 1), empty, 550 x 265 x 50 mm   |
| <b>Drill Guides</b> for sled prostheses                                   |            |  |
| 2   | 15-2201/60 | large  |
| 3   | 15-2201/52 | medium   |
| 4   | 15-2201/46 | medium-small   |
| 5   | 15-2201/40 | small  |
| 6   | 15-2042    | <b>Inserting Forceps</b> , for tibial plateaus all-polyethylene and trial plateaus, 215 mm         |
| <b>Cancellous Bone Compressors</b> , for tibial plateaus all-polyethylene |            |  |
| 7   | 15-2201/14 | Ø 50-55 mm   |
| 8   | 15-2201/15 | Ø 45 mm  |
| 9   | 15-2201/19 | <b>Cancellous Bone Compressor</b> , for tibial plateaus metal-backed, Ø 45-55 mm                   |
| <b>Trial Sled Prostheses</b>  |            |  |
| 10  | 15-2021/05 | large  |
| 11  | 15-2021/04 | medium   |
| 12  | 15-2021/03 | medium-small   |
| 13  | 15-2021/02 | small  |
| 14  | 15-2201/12 | <b>Fixation Pins</b> , for drill guides, Ø 2 mm, 60 mm   |
| 15  | 15-2201/53 | <b>Fixation Pin</b> , to stabilize the drill guide, Ø 5.4 mm, 50 mm (4 ea.)                        |
| 16  | 15-2201/13 | <b>Holding and Inserting Forceps</b> , for drill guides  |
| 17  | 15-2040/09 | <b>Inserting Forceps</b> , for tibial plateaus metal-backed  |
| 18  | 15-2040/08 | <b>Set of Trial Plateaus</b> , on storage tray, Ø 45, 50, 55 mm, heights: 7, 9, 11, 13 mm (12 ea.) |



Tray, Container 2

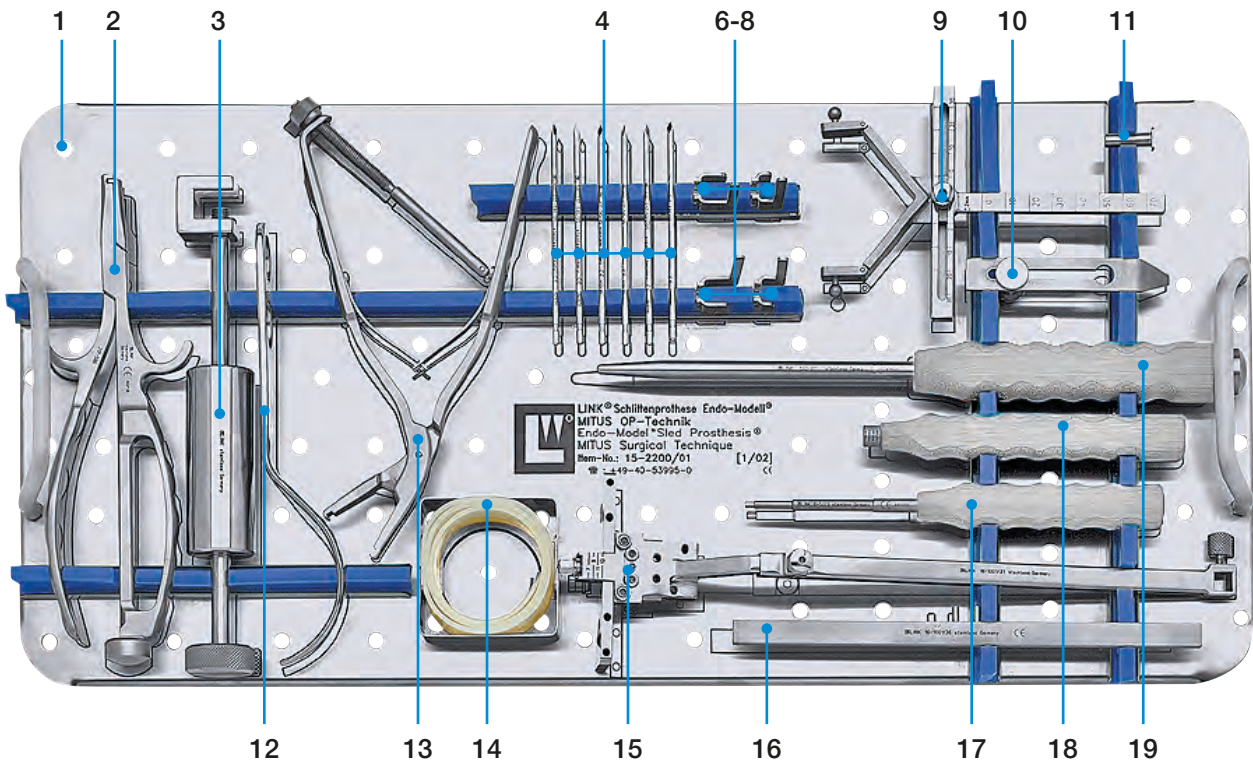

|    |            |  |
|----|------------|--|
| 1  | 15-2200/01 | Tray (Container 2), empty, 550 x 265 x 50 mm           |
| 2  | 317-586    | Insertor/Extraction Forceps, for fixation pins, 210 mm |
| 3  | 15-2201/18 | Extractor, for fixation pins, to be used with 317-586  |
| 4  | 317-585/95 | Fixation Pins, Ø 3 mm, 95 mm (6 ea.)                   |
|    |            | <b>Eminentia Saw Guides</b>                            |
| 5  | 15-2201/32 | left, height A   |
| 6  | 15-2201/37 | left, height B   |
| 7  | 15-2201/33 | right, height A  |
| 8  | 15-2201/38 | right, height B  |
| 9  | 15-2201/34 | Tibial Alignment Device, extramedullary                |
| 10 | 15-2201/35 | Stylus   |
| 11 | 15-2201/39 | Spacer Bolt, to 15-2201/31                             |
| 12 | 15-2201/11 | Retractor  |
| 13 | 15-2201/10 | Inserting Forceps, for trial sled prostheses           |
| 14 | 317-538/01 | Flexible Belt, 495 mm                                  |
| 15 | 15-2201/31 | Tibial Saw Guide Base, adjustable                      |
| 16 | 15-2201/36 | Alignment Rod, transversal, 200 mm                     |
| 17 | 10-5373    | Hex Screwdriver, hex 2.5 mm, 180 mm                    |
| 18 | 317-648    | Universal Wrench, hex 6.0 mm, 140 mm                   |
| 19 | 130-611    | Impactor, 280 mm                                       |

**Additional Instruments** (not included in Instrument Set, complete)

**Trial Tibial Plateaus, Ø 58 mm,**  
suitable for tibial plateaus all-polyethylene  
(without metal-backed)

| REF        | Height mm | Width mm |
|------------|-----------|----------|
| 15-2047/13 | 7         | 31       |
| 15-2047/14 | 9         | 31       |
| 15-2047/15 | 11        | 31       |
| 15-2047/16 | 13        | 31       |



**Trial Tibial Plateaus Height 8 mm,**  
suitable for tibial plateaus with metal-backed

| REF        | Height mm | Width mm | Ø mm |
|------------|-----------|----------|------|
| 15-2040/33 | 8         | 22.5     | 45   |
| 15-2040/34 | 8         | 25.0     | 50   |
| 15-2040/35 | 8         | 27.5     | 55   |

**15-2048/04**

**Storage Tray, separate**

for all-polyethylene trial tibial plateaus, Ø 58 mm



**15-2048/05**

**Storage Tray, separate**

for trial tibial plateaus height 8 mm

**15-2201/58**

**Drill and Saw Guide (templates)**

for tibial plateaus all-polyethylene,  
Ø 58 mm





Tibial Saw Guide 15-2201/30



The tibial saw guide consists of a base with one cutting platform for medial resection and another for lateral resection. The stylus is inserted into a hole on the cutting platform. The spacer bolt is fixed on the opposite side. To protect the intercondylar eminence, eminentia saw guides are available.

The adjustable extramedullary tibial saw guide base determines the correct axial alignment. A transversal alignment rod helps to align the saw guide horizontally. The saw guide is fixed distally using a plastic connector. The saw guide is secured proximally with fixation pins.



317-538/01  
Flexible Belt,  
495 mm



15-2201/34  
Tibial Alignment De-  
vice,  
extramedullary

15-2201/32 - /38  
Eminentia Saw Guide,  
left and right

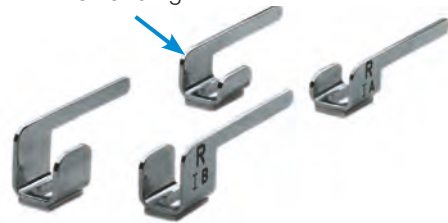

15-2201/35  
Stylus

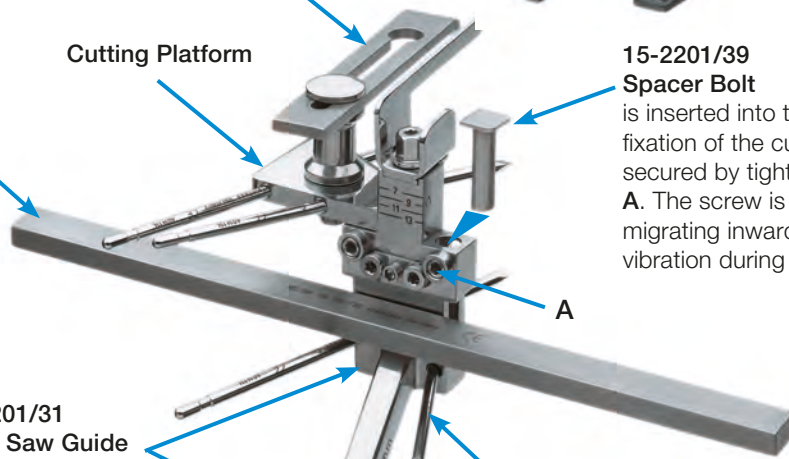

15-2201/36  
Alignment Rod,  
transversal,  
200 mm

Cutting Platform

15-2201/39  
Spacer Bolt

is inserted into the unused opening for fixation of the cutting platform and is secured by tightening fixation screw **A**. The screw is thus prevented from migrating inwards as a result of the vibration during sawing

15-2201/31  
Tibial Saw Guide  
base, adjustable



317-585/95  
Fixation Pins, Ø 3 mm, 95 mm  
for fixation of the tibial saw guide

Additional Instruments



**Sawblades,**  
without offset teeth, 1.24 mm thick

| Width (A)<br>25 mm | Width (A)<br>13 mm | Fitting           |  |
|--------------------|--------------------|-------------------|--|
| 317-654/10         | 317-656/10         | Synthes           |  |
| 317-654/11         | 317-656/11         | Aesculap Combi    |  |
| 317-654/13         | 317-656/13         | Zimmer/Hall Combi |  |
| 317-654/14         | 317-656/14         | Stryker System 4  |  |

15-2040/08

**Set of Trial Plateaus** on storage tray,  
Ø 45, 50, 55 mm, heights: 7, 9, 11, 13 mm (12 ea.)



15-2048/04

**Storage Tray, separate**  
for all-polyethylene trial tibial plateaus, Ø 58 mm



15-2048/05

**Storage Tray, separate**  
for trial tibial plateaus height 8 mm



15-2201/11

**Retractor**



**Adapter for Power Tool Chuck**

Different adapters are available to ensure compatibility to allow various connections:

| REF        | Attachment   |
|------------|--|
| 16-3283/01 | Jakobs-Fitting (E)  |
| 16-3284/00 | AO-Fitting (D)      |
| 16-3285/00 | Harris-Fitting (C)  |

**Hudson-Fitting**  
Standard tool connection.

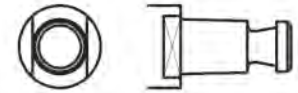

**X-ray Templates, 110% actual size, one sheet**

| REF        | Application   |
|------------|---|
| 15-2021/10 | for Unicondylar Sled Prosthesis<br>15-2020/40 to 15-2020/60                                   |
| 15-2021/14 | for Tibial Plateaus, metal-backed<br>15-2030/02 to 15-2030/13 and<br>15-2230/02 to 15-2230/13 |
| 15-2021/13 | for Tibial Plateaus, all-polyethylene<br>15-2028/01 to 15-2028/16                             |

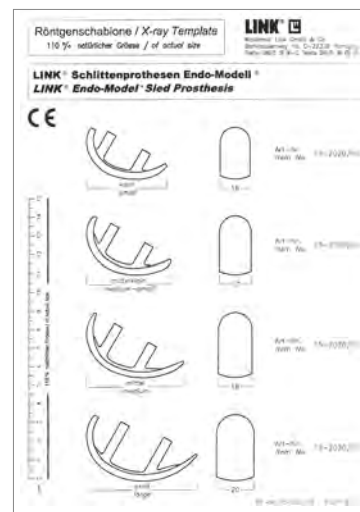

**Further Information**

**LINK PorEx Technology**  
(TiNbN = Titanium-Niob-Nitride) Surface Modification  
for metal sensitive patients

For more information please register at [mediathek.linkorthopaedics.com](http://mediathek.linkorthopaedics.com)

## Important Information for X-ray Investigations

### X-ray investigations

X-ray images can be used to evaluate implant positioning post-operatively. Images taken from certain angles can create the impression that the implant has broken.



Fig. 1: Post-operative X-ray 1

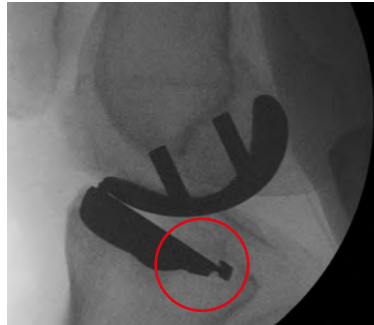

Fig. 2: Post-operative X-ray 2

### Attention:

The LINK Tibial Plateau metal-backed is delivered as one piece, i.e. the Polyethylene Component and the Metal Component are pre-assembled as a single unit. The manufacturing process of the components has never been changed. For secure connection the polyethylene engages with a mechanical coupling device.

These technical specifications can lead X-ray images taken from certain angles to appear distorted, which may give the impression that the Tibial Plateau is broken. Examples of such distorted images are shown below:



Fig. 3a: Photograph of externally rotated tibia



Fig. 3b: X-ray image of figure 3a

As a broken Tibial Plateau is most unlikely, the diagnosis should be verified with additional X-ray images.

**Verification:** Rotation of the tibia ensuring strictly lateral alignment for the follow-up X-ray.



Fig. 4a: Photograph of tibia from a strictly lateral position

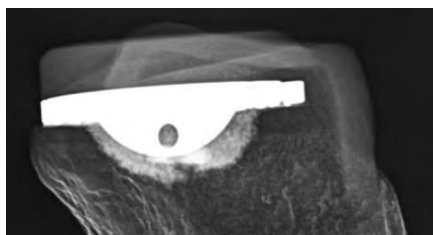

Fig. 4b: X-ray image of figure 4a

| Specified indications and contraindications:   | LINK Sled | LINK Sled with PorEx* |
|--|-----------|-----------------------|
| <b>General Indications:</b>  |           |                       |
| Unicompartmental cartilage defect with limitation of mobility due to degeneration or post-traumatic arthrosis/arthritis.   | <b>X</b>  | <b>X</b>              |
| Unicompartmental arthrosis in a stable knee (intact ligaments including anterior and posterior cruciate ligaments) with a correctable varus / valgus deformity (<10°). | <b>X</b>  | <b>X</b>              |
| <b>Contraindications (absolute):</b>   |           |                       |
| Acute / chronic infections, local or systemic – insofar as they compromise the successful implantation of a unicompartmental Sled prosthesis.                          | <b>X</b>  | <b>X</b>              |
| Any neuro-muscular disease affecting the limb which would put an arthroplasty 'at risk'.   | <b>X</b>  | <b>X</b>              |
| Insufficient / inadequate bone stock preventing stable fixation of either prosthesis.  | <b>X</b>  | <b>X</b>              |
| Unstable knee (Insufficient crucial and/or collateral ligaments).  | <b>X</b>  | <b>X</b>              |
| Non-compliant patient.   | <b>X</b>  | <b>X</b>              |
| <b>Contraindications (relative):</b>   |           |                       |
| Hypersensitivity to (implant) materials (LINK PorEx indication).   | <b>X</b>  | -                     |

\* LINK PorEx: TiNbN = Titanium Niobium Nitride; hypoallergenic coating (gold colour).





Please note the following regarding the use of our implants:

**1. Choosing the right implant is very important.**

The size and shape of the human bone determines the size and shape of the implant and also limits the load capacity. Implants are not designed to withstand unlimited physical stress. Demands should not exceed normal functional loads.

**2. Correct handling of the implant is very important.**

Under no circumstances should the shape of a finished implant be altered, as this shortens its life span. Our implants must not be combined with implants from other manufacturers. The instruments indicated in the Surgical Technique must be used to ensure safe implantation of the components.

**3. Implants must not be reused.**

Implants are supplied sterile and are intended for single use only. Used implants must not be used again.

**4. After-treatment is also very important.**

The patient must be informed of the limitations of the implant. The load capacity of an implant cannot compare with that of healthy bone!

**5. Unless otherwise indicated, implants are supplied in sterile packaging.**

Note the following conditions for storage of packaged implants:

- Avoid extreme or sudden changes in temperature.
- Sterile implants in their original, intact protective packaging may be stored in permanent buildings up until the "Use by" date indicated on the packaging.
- They must not be exposed to frost, dampness or direct sunlight, or mechanical damage.
- Implants may be stored in their original packaging for up to 5 years after the date of manufacture. The "Use by" date is indicated on the product label.
- Do not use an implant if the packaging is damaged.

**6. Traceability is important.**

Please use the documentation stickers provided to ensure traceability.

**7. Further information** on the material composition is available on request from the manufacturer.

**Follow the instructions for use!**

### Waldemar Link GmbH & Co. KG, Hamburg

All content in this catalog, including text, pictures and data, is protected by law. Every instance of use, whether in part or in whole and which is not permitted by law, is subject to our prior consent. In particular, this applies to the reproduction, editing, translation, publishing, saving, processing, or passing on of content stored in databases or other electronic media and systems, in any manner or form. The information in the catalogs is solely intended to describe the products and does not constitute a guarantee.

The Surgical Technique described has been written to the best of our knowledge and belief, but it does not relieve the surgeon of his/her responsibility to duly consider the particularities of each individual case.

Products shown in this document may not be available in your country. The product availability is subject to the approval and/or registration regulations of the respective country. Please contact Waldemar Link GmbH & Co. KG if you have questions about the availability of LINK products in your country.

Waldemar Link GmbH & Co. KG and/or other corporate affiliated entities own, use or have applied for the following trademarks in many jurisdictions: LINK, BiMobile, SPII, Modell Lubinus, E-Dur, EndoDur, T.O.P. II, BetaCup, CombiCup PF, CombiCup SC, CombiCup R, MobileLink, C.F.P., LCU, SP-CL, LCP, MIT-H, Endo-Model, Endo-Model SL, MP, MEGASYSTEM-C, GEMINI SL, SPAR-K, LCK, Link OptiStem, HX, TiCaP, X-LINKed, PorAg, LINK PorEx, BiPorEx, PorEx-Z, TrabecuLink, Tilastan, customLINK, RescueSleeve, Stactip, VACUCAST.

Other trademarks and trade names may be used in this document to refer to either the entities claiming the marks and/or names or their products and are the property of their respective owners.

