







Endo-Model – M

Modular Knee Prosthesis System
with Segmental Bone Replacement Components

CE 0482

Explanation of Pictograms			
	Manufacturer		Item number
	Material (number)		Product meets the applicable requirements, which are regulated in the EU harmonization legislation for the affixing of the CE marking.

Endo-Model – M

Modular Knee Prosthesis System
with Segmental Bone Replacement Components

- 02 System Description
- 03 LINK PorEx Technology (TiNbN = Titanium Niobium Nitride)

Assembly Instruction

- 04 Assembly: Plateau with anti-luxation device
- 05 Assembly: Modular stems

- 06 Indications / Contraindications

Surgical Technique

- 07 Opening
- 08 Femoral preparation
- 16 Tibial preparation
- 19 Implantation: Implant alignment
- 20 Implantation: Rotational knee prosthesis
- 23 Implantation: Hinge knee prosthesis

- 29 Accessories: X-ray templates
- 30 Further Information
- 31 Literature

Important information

The **Endo-Model – M Modular Intracondylar Total Knee Joint Prosthesis** is an additional version of the **LINK Endo-Model Rotational and Hinge Knee System**.



Based on the same low friction principle, the rotational movement of this prosthesis passes smoothly through a pivot point in the physiological region. The Endo-Model – M Rotation Knee Joint Prosthesis permits flexion of the joint up to 142°. Due to the special shape of the tibial contact surfaces and physiological rotation, the kinematics of this prosthesis allow for cushioned transmission of force. The Hinge Knee Prosthesis permit only flexion of the joint up to 142°, without rotation.

With every step, and especially when falling, torsional stresses are transmitted to the prosthetic anchorage which adversely affects the longevity of the cement interface. The cushioned transmission of forces, made possible by the design features, provides a dampened impact upon the boundary layer of the cement interface. The resection required during implantation of the Endo-Model–M Knee Joint Prosthesis amounts to only 14 mm in the tibia-femur joint plane. With the medium sized intracondylar component only 30 mm wide, there is usually ample bone mass left in the event a revision is necessary. Normally, the resection is smaller compared with a Total Knee implant. Design and dimensioning of the

Rotation Knee Joint Prosthesis significantly simplify the surgical procedure. Mounting of the femoral and tibial components is a simple task, requiring only one special introducer instrument for the UHMWPE Plateau. Both components are linked by the special anti-luxation device of the plateau without reducing the motion and rotational sequences. Implantation is facilitated by a small number of easily manipulated instruments. The Hinge Knee Prosthesis is linked by an axis mechanism.

Flexion and rotation of the knee prosthesis occurs in a cross joint. Hyperextension amounts to 2°. The compromise axis lies in the region of the physiological pivot point. Flexion of up to 142° is possible. Often during endoprosthesis replacement of the knee joint, an advancement of the patella or of the patella bearing surface is observed. By displacing the femoral component dorsally relative to the tibial axis, the natural range of motion is also preserved in the patello-femoral joint. This protects against progression of retropatellar arthrosis. Rotation of the prosthesis terminates in the extended position by form closure and assures a secure posture. The rotational option increases continuously with flexion. This rotation is

limited primarily by the capsule ligament apparatus. The body weight, bearing on the joint, elastically dampens further rotation. The femoral component of the Endo-Model – M Total Knee Joint Prosthesis has a normal valgus position of 6°.

Both prosthesis components are broadly supported on the respective knee joint surfaces so that the compression strength of the cancellous bone in the femur and tibia, is not exceeded. The flanges of the femoral component are anatomically shaped. Its ventral depression provides a smooth transition from the implant to the trochlear groove.

The modular prosthesis stems are available in cemented and cementless versions (with smooth surface or longitudinal ribs respectively). To achieve a central position within the medullary canal, the tips of the cemented stems are fitted with star shaped UHMWPE caps. Direct contact of the metal stem with the inner wall of the bone is thereby prevented.

The stems are supplied in lengths of 50 up to 280 mm. Special femoral segments for revision surgery of resurfacing knee implants (reconstruction of condyles) and for tumor cases are also available. It is absolutely necessary to use these segments only in combination with longer stem.

LINK PorEx Technology

(TiNbN = Titanium Niobium Nitride)

The hypoallergenic LINK PorEx surface modification leads to a ceramic-like surface, which significantly reduces the release of ions and can improve tolerance in patients who are sensitive to metal¹.

This surface modification is extremely hard and possesses abrasion properties similar to those of ceramics. These qualities and the wetting angle of the surface give it a low friction coefficient when in contact with fluids.

¹ Internal Study of the influence of TiNbN-coating on the ion release of CoCrMo-alloys in SBF buffer simulator testing.



Assembly: Plateau with anti-luxation device



After cementation of tibial and femoral components the UHMWPE plateau is removed from the tibial tray by loosening the trial screw. With the knee in flexion both components are assembled.

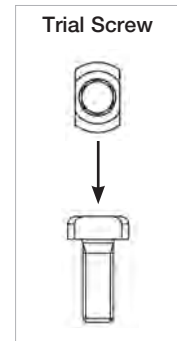

The tibial plateau is attached to the introducer and slid between the femoral and tibial components so that its medial lip grabs over the flange of the femoral bushing. Care must be taken that the dovetailed medial and lateral parts fit into the groove at the posterior rim of the metal tibial tray (fig. B).

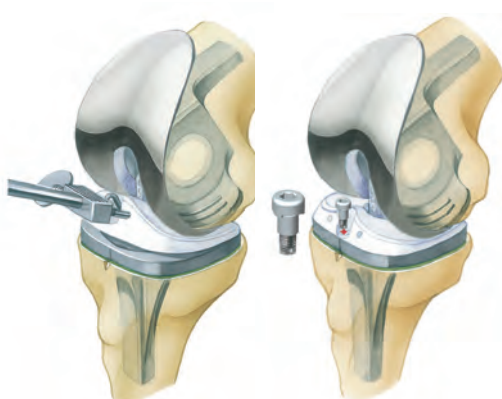
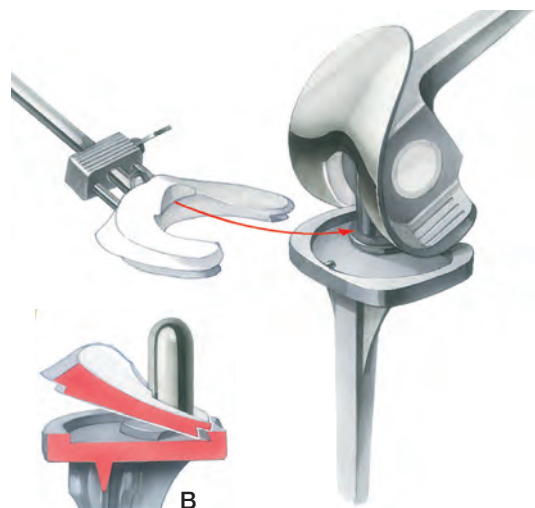

In this position the UHMWPE plateau is pressed down into the metal tray and firmly fixed by the self-locking screw.

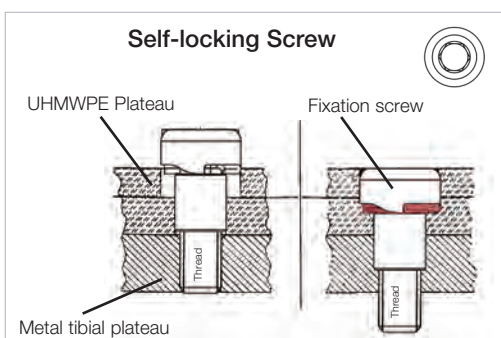
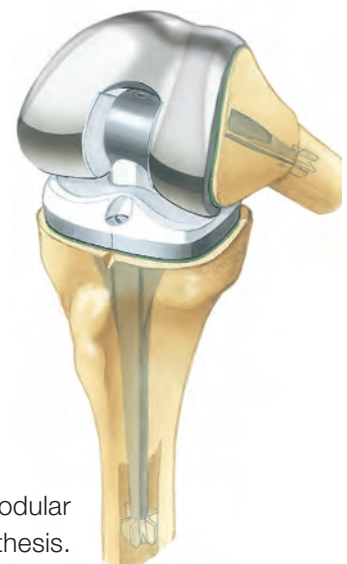

Implanted Endo-Model Modular Knee Prosthesis.

Assembly: Modular stems



The modular stems are joined by a cone assembly. To ensure rotational stability, the stem has two opposing flanges which are inserted in the medial and lateral grooves on the femoral / tibial components.

The current version V02 features a 6 mm groove for attachment of modular stems with female taper and flanges of 3 mm or 6 mm. When attaching modular stems with 3 mm flanges, the stem must be orientated on the taper so that the threaded hole for the counter screw is not obscured (A). To this end, the alignment aid (15-6096/00) for modular stems is used (B). Modular stems with 6 mm flanges cannot be combined with Endo-Model implants with 3 mm grooves.



By tightening the locking screw (2) located in the taper (3) of the tibial respectively femoral component its pointed tip presses the stem (1) firmly onto the taper. A counter screw (4) secures the stem locking screw against loosening. The screw fixation is performed medially. **Screws are only to be tightened hand-tight.**

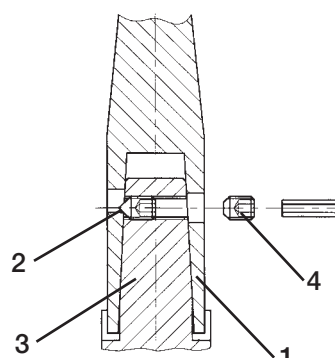
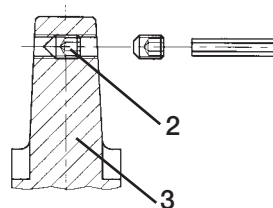

Counter Screw



Important Information:

The locking screw (optionally pre-assembled), the counter screw and one replacement screw each are included separately in the packaging.

Specified Indications and Contraindications for Endo-Model – M Modular Knee Prosthesis System	Products	Rotating Hinge	Pure Hinge	Components with LINK PorEx (TiNbN) surface modification
General Indications				
<ul style="list-style-type: none"> Mobility limiting diseases, fractures or defects of the knee joint, distal femur or proximal tibia which cannot be treated by conservative or osteosynthetic procedures 		X	X	X
Indications				
<ul style="list-style-type: none"> Primary and secondary osteoarthritis 		X	X	X
<ul style="list-style-type: none"> Rheumatoid arthritis 		X	X	X
<ul style="list-style-type: none"> Revision after primary or revision total knee replacement 		X	X	X
<ul style="list-style-type: none"> Bone necroses which won't compromise the successful implantation of a hinged total knee endoprosthesis 		X	X	X
<ul style="list-style-type: none"> Varus and valgus deformity with contracture or laxity of the medial or lateral stabilizers 		X	X	X
<ul style="list-style-type: none"> Extreme cases of varus/valgus deformities (20-30°), rheumatoid arthritis, muscular deficiency and any kind of genu laxum 		–	X	–
<ul style="list-style-type: none"> Oncological and revision surgery in lower limb (in conjunction with the Endo-Model-W and the Megasytem-C) 		X	X	–
<ul style="list-style-type: none"> Sensitization against one or more components of used CoCrMo implant materials 		–	–	X
Contraindications				
<ul style="list-style-type: none"> Acute or chronic infections, local and systemic insofar as they compromise the successful implantation of a hinged total knee endoprosthesis 		X	X	X
<ul style="list-style-type: none"> Allergies to (implant) materials 		X	X	–
<ul style="list-style-type: none"> Distinctive muscular, nerve, vascular or other diseases which put the affected limb at risk 		X	X	X
<ul style="list-style-type: none"> Insufficient bone integrity which prevents a stable anchorage of the prosthesis 		X	X	X

These indications/contraindications refer to standard cases. The ultimate decision on whether or not an implant is suitable for a patient must be made by the surgeon based on his/her individual analysis and his/her experience.

Opening



01

A rein placed posteriorly around the condyles helps to stabilize the femur when the knee is flexed.

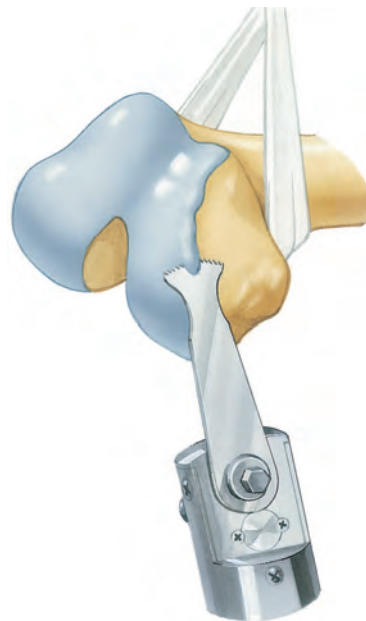

02

Osteophytes are removed to restore the physiologic contour of the condyles.

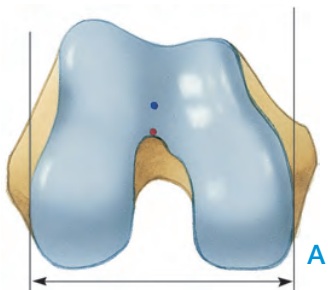

03

The width of the condyles determines which size of knee prosthesis to select (A).

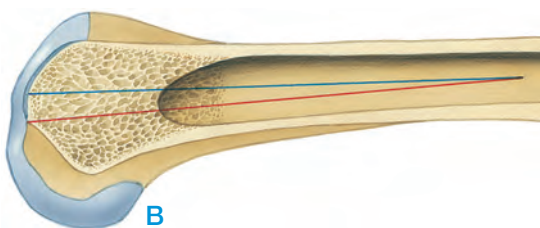

The red line indicates the axis resulting from the initial opening of the femoral canal. The blue line indicates the axis of the femur and the final position of the stem of the femoral prosthesis components (B).

Femoral Preparation

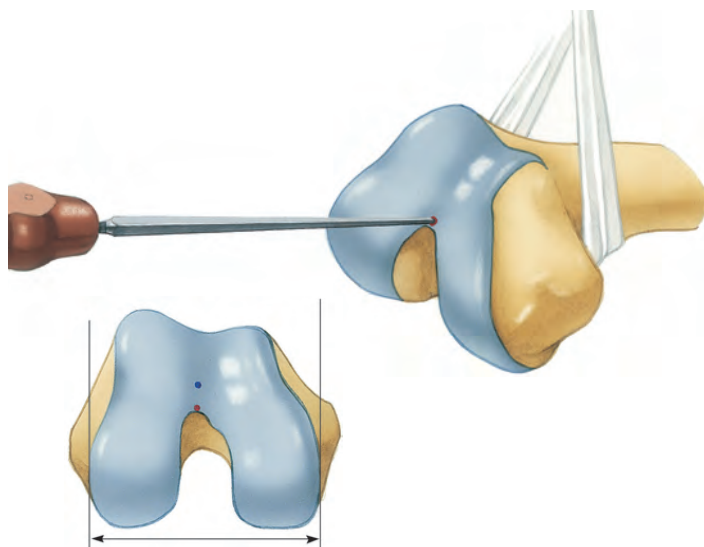

04

To initially open the femoral canal, the bone awl is placed at the lowest point (red) of the trochlear groove in the patellofemoral joint. The point lies at the tip of the intercondylar fossa.

05

The femoral canal is opened with an 8 mm milling drill at the point previously marked.

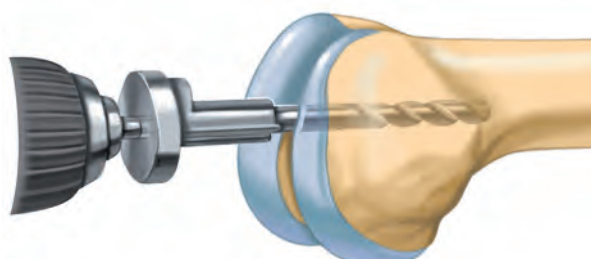

06

The femoral canal is carefully widened with a ball reamer.

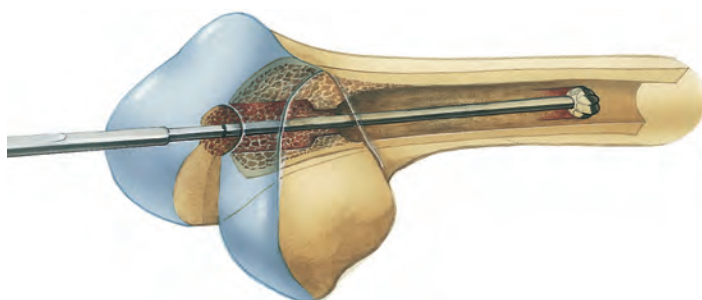

Femoral Preparation

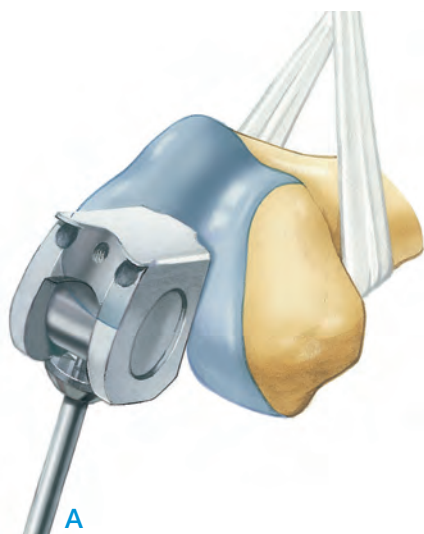

07

The femoral saw guide corresponds in shape to the portion of the femoral component that will lie within the bone (A). The threaded rod with handle is attached to the anterior part of the femoral saw guide. To centrally align the instrument in the femoral canal, the extension stem is screwed into the femoral saw guide. At the proximal end of the extension stem, a metal centralizer adapted to the diameter of the canal is attached (B). The saw guide is advanced until its box is in contact with the condyles. The rotational alignment is correct when the anterior groove of the resection box matches the trochlear groove when viewed from above (C).

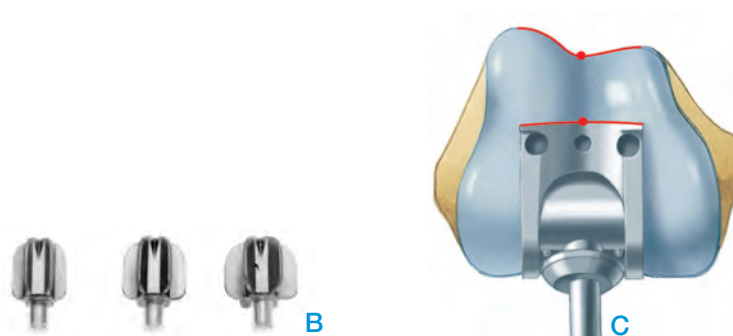

08

Alternatively, the femoral saw guide can be aligned with the femur and the handle with the aid of the alignment guide and can be fixed with fixation pins.

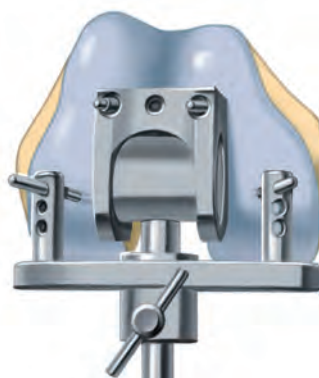

Femoral Preparation

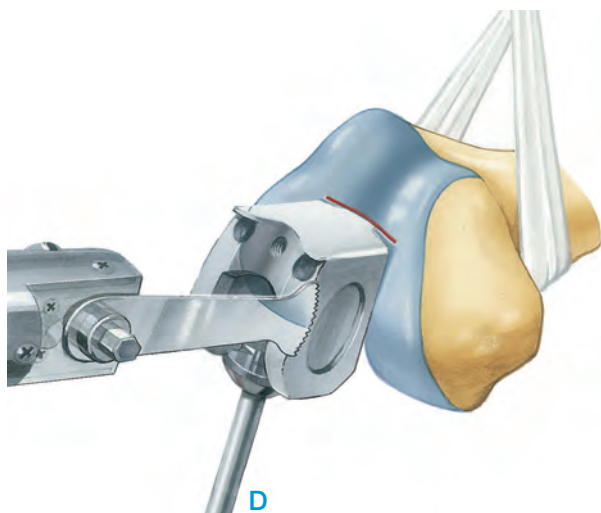

09

Anterior and bilateral femoral osteotomies are performed with the oscillating saw along the surface of the box (D).

The resected bone at the junction of the condyles should be carefully osteotomized step by step with the saw. This should allow the box of the femoral saw guide to be inserted up to the level of the condyles after the resected bone has been removed with a lambotte osteotome (E).

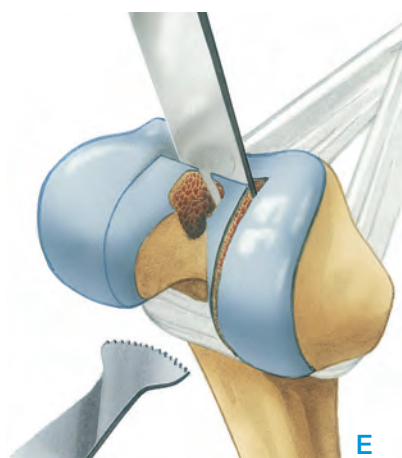

10

In order to adapt the anterior femoral canal to the slight groove in the prosthesis and the saw guide between the anterior surface of the intracondylar box and the stem, the cancellous bone retrograde to the trochlear groove is hollowed out with the oscillating saw. This process creates a step in the cancellous bone attached in a proximal direction, so that this can be removed with a ball reamer or broach.

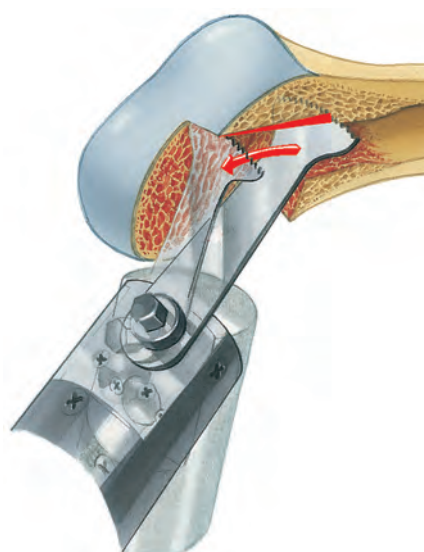

Femoral Preparation

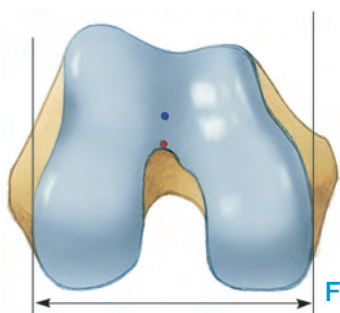

11

The femoral canal is intentionally opened far in a posterior direction first (Fig. F, red point). The inserted femoral guide must then be shifted anteriorly (Fig. F, blue point) until the stem of the femoral saw guide (locked in extension) is aligned with the distal femur (Fig. G, blue position of femoral saw guide), so as to prevent hyperextension.

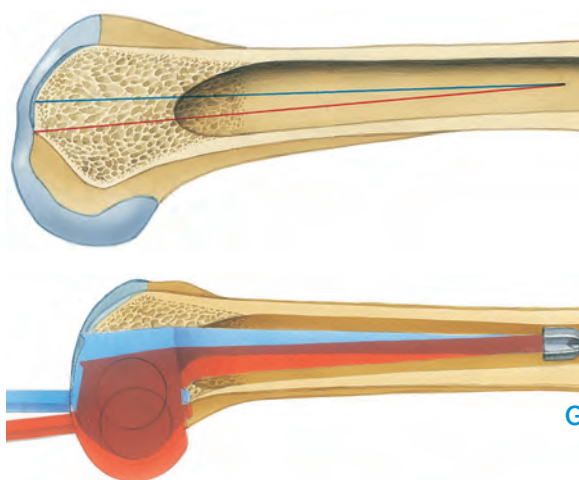

12

If proper axial alignment of the femoral saw guide cannot be achieved after the previous steps have been performed, the femoral saw guide will have to be shifted further in an anterior direction. This requires resection of more bone from the intracondylar portion of the trochlear groove. A lambotte osteotome impacted into the bone can be used to define the extent of the osteotomy with the oscillating saw. The

impacted osteotome also guides the saw blade until the saw has cut a groove in the bone. It is important to perform the resection gradually, verifying proper alignment of the axis of the femoral saw guide with the axis of the femur. After this additional resection, the steps of hollowing out the cancellous bone proximal to the trochlear groove and removing cancellous bone from the anterior portion of the femoral canal proximal to the joint must be repeated.

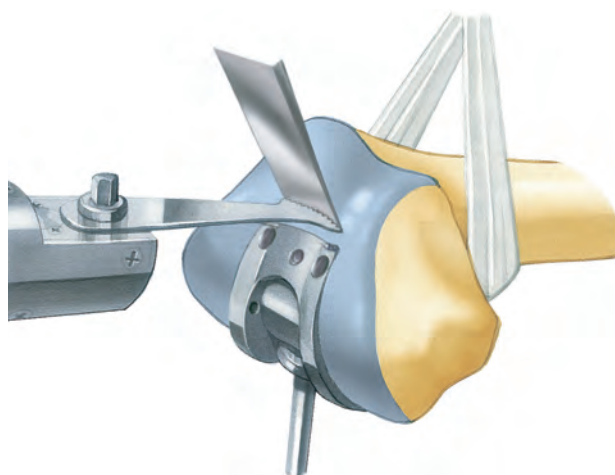

Femoral Preparation

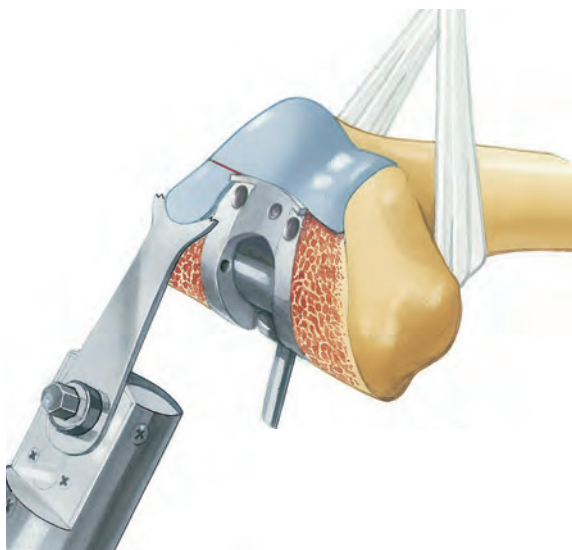

13

The box of the femoral saw guide is advanced into the bone until the contour of the anterior groove of the saw guide is congruent with the trochlear groove in the patellofemoral joint. The femoral saw guide is fixed with two fixation pins. The condyles are then adapted to match the curved surface of the resection box with an oscillating saw.

14
After the trochlear groove resection guide is attached to the saw guide, the anterior surface of the distal femur is resected to fit the shape of the implant.

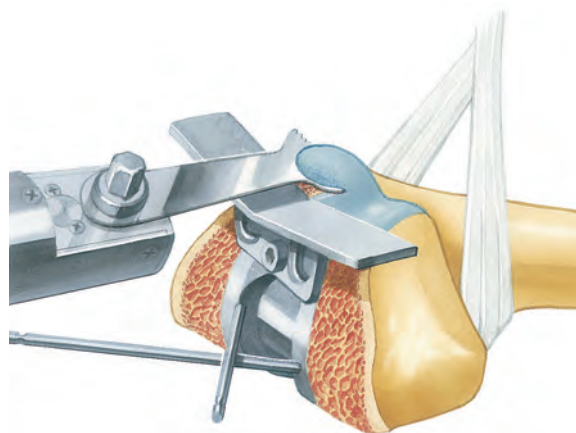

15

The remaining anterior edge is rounded off with a trochlear groove rasp. Residual cartilage should be removed.

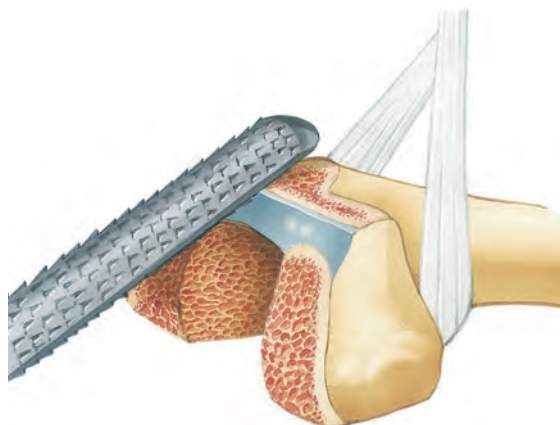

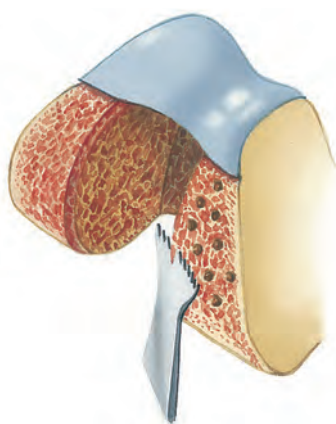

16

In sclerotic bone, it is a good idea to achieve a slight sagittal curvature of the inner edges of the condyles to match the interior contour of the implant between box and flanges. Soft cancellous bone will conform to the interior contour of the flanges; sclerotic bone must be shaped to fit. In cases where the medial femoral condyle is sclerotic, cement retention holes are drilled to improve fixation of the implant.

17

When using cemented modular stems, a cylindrical bone plug is inserted into the proximal region of the femur to seal the femoral canal. The bone cylinder is advanced to a depth corresponding to the overall length of the stem (see Implants and Instruments Catalog, page 12). This plug provides hemostasis higher up in the femoral canal and seals the canal when cement is injected during later implantation of the femoral component.

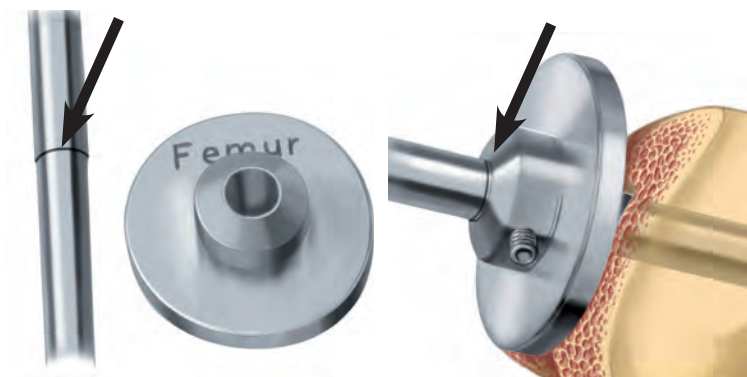
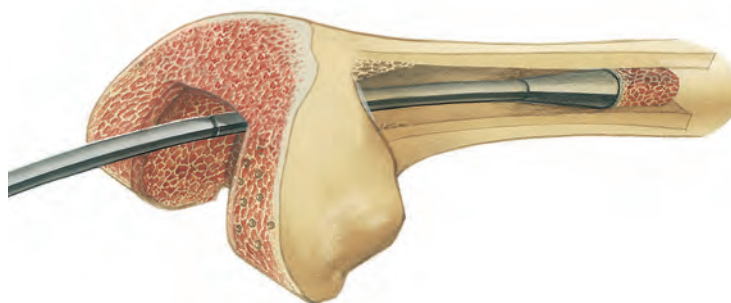

18

When using cementless conical or cylindrical modular stems, the corresponding attachment plate (femur or tibia) is affixed to the shaft of the broach so that the inscribed side of the plate is flush with the bone on the averted side and the black marking ring on the shaft of the broach is barely visible (see arrow). The attachment plate is fixed with the inbus screw.

Femoral Preparation

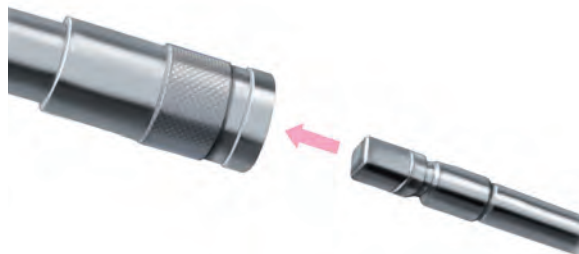

19

The broach is secured to a handle for milling and broaching. Machine operation of the broach is not permitted.

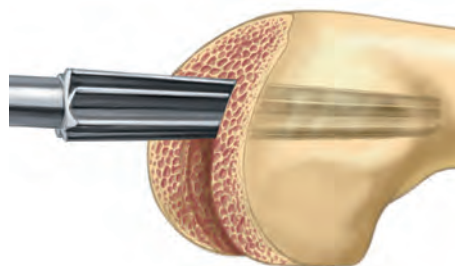

20

The awl is subsequently carefully screwed in in a clockwise direction until contact of the attachment plate with the bone. In this position, stable cortical anchoring should be achieved.

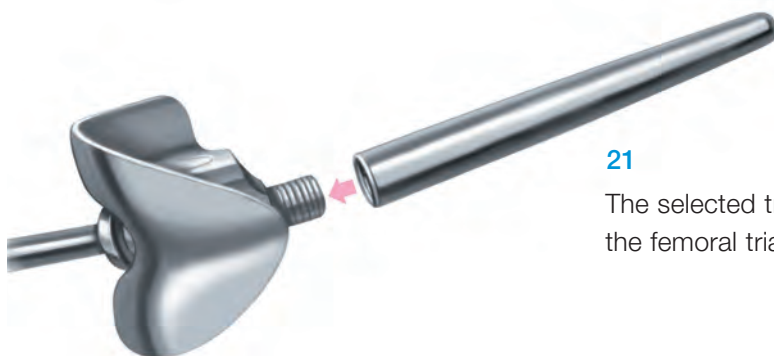
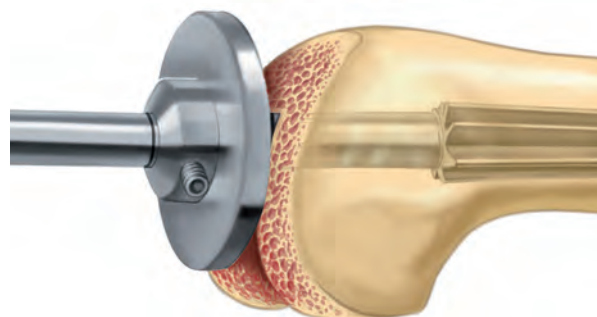

21

The selected trial stem is screwed onto the femoral trial prosthesis.

Femoral Preparation

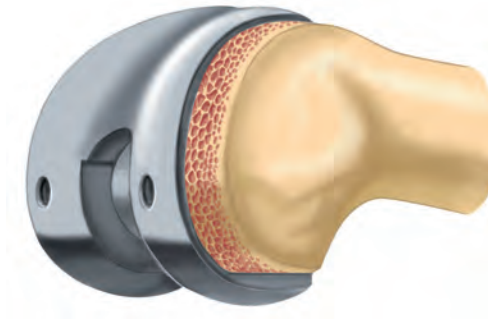

22

Fitted trial femoral prosthesis.

Tibial Preparation

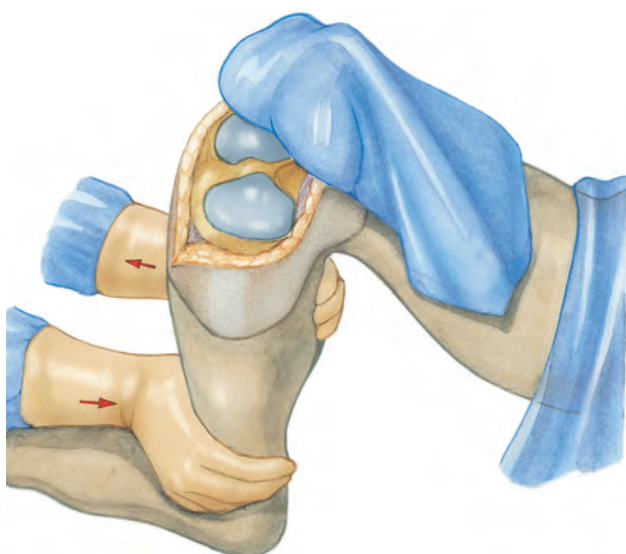

23

Next, the tibia is exposed. The hand on the opposite side to the approach is placed in the popliteal fossa with the thumb abducted, while the other hand grasps the ankle anteriorly. Applying traction and shear force with the hands with slight external rotation exposes the proximal tibia.

24

The tibial canal is marked with a broach at the junction between the anterior and middle third of the sagittal diameter of the tibial surface, immediately anterior to the intercondylar eminence. The point described lies above the center of the medullary canal of the tibia. An 8 mm twist drill is used to open the tibial canal.



25

The guide bar is subsequently introduced and the T-shaped handle is unscrewed.

Tibial Preparation

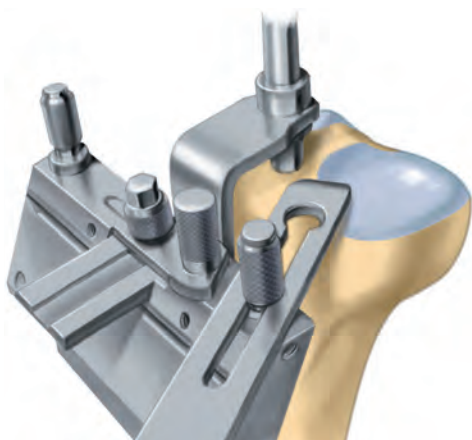

26

The coupling is pushed over the guide bar and is connected to the tibial saw guide with a caliper. The caliper is aligned to the highest level of healthy plateau surface during initial procedures. The maximum resection level is 10 mm. In the case of revision, precisely enough material should be resected in order to leave a planar osseous surface. In each case, the dorsal slope is 0° . To check the slope angle and to rotationally align the saw guide, the alignment rod can be affixed to the tibial saw guide anteriorly.

27

The saw guide is secured by means of fixation pins (at least four). Of these, at least two angled boreholes (black borders) and two straight boreholes are to be used. Resection is subsequently carried out. The rotational alignment is marked for the later positioning of the tibial implant with a sterile pin or scoring of the anterior cortex.



28

The preparation of the tibial canal is carried out with ball reamers (for cemented modular stems) or broaches (conical or cylindrical for cementless modular stems) as described in femoral preparation. The broaches are joined to the tibial attachment plate.

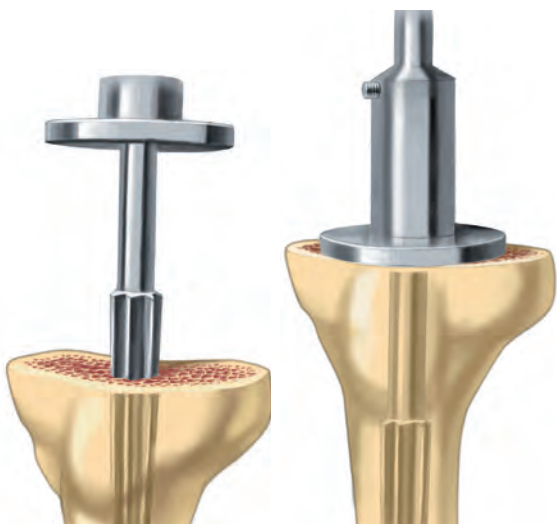

Tibial Preparation

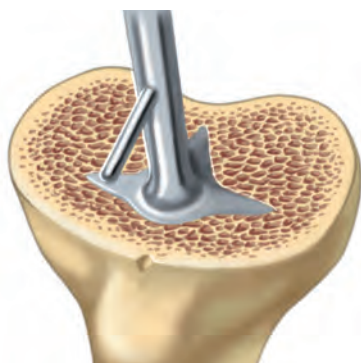

29

The profile of the implant in the corresponding implant size is inserted into the proximal tibia using the proximal tibial impression instrument. The anterior alignment pin of the instrument is then aligned with the rotation marking of the anterior cortex carried out prior to this. The instrument is driven in deep enough so that the upper surfaces are in line with the resection level.

30

The trial tibial prosthesis is attached posteriorly to the selected trial stem. The threaded rod with handle is screwed on in a proximal direction and the trial implant is driven in.



31

The tibial and femoral trial implants are coupled. The trial tibial plateau is fitted with the aid of the introducer.



Implantation: Implant Alignment

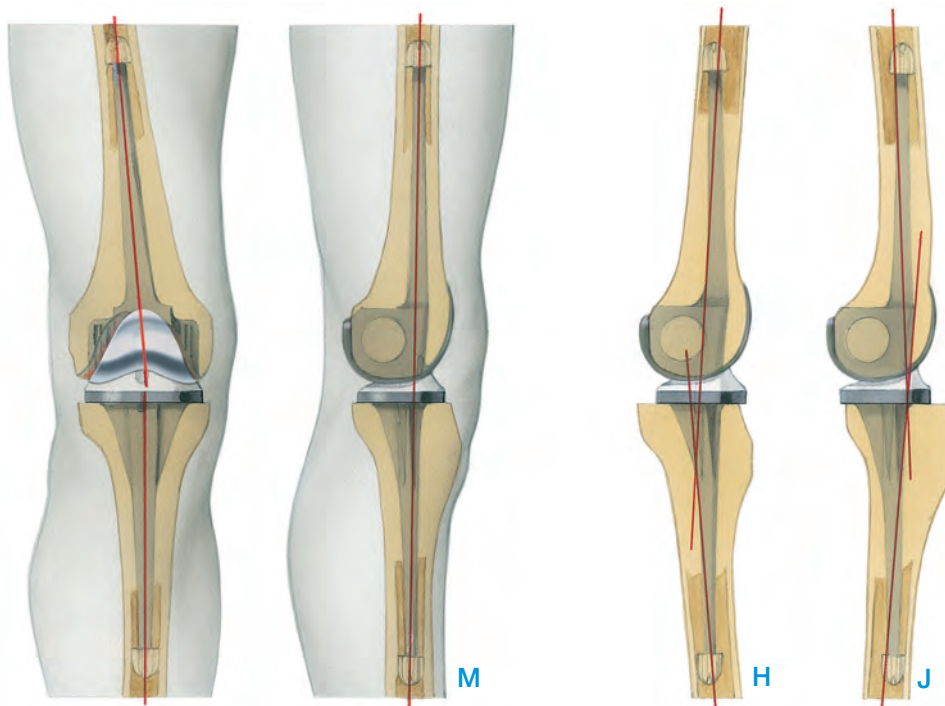
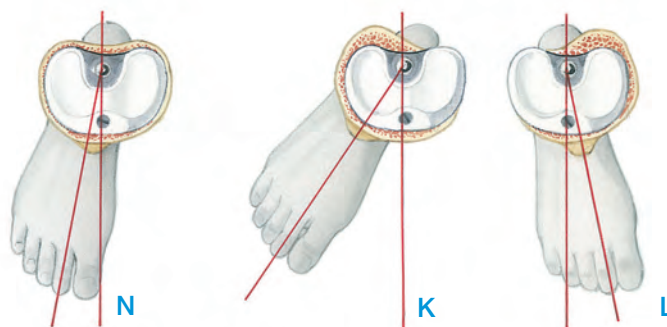

Figure with patella flange



32

It is now important to check the sagittal and rotational alignment of the implant before cementing the implant components in place:

- H** hyperextension
- J** impaired extension
- K** external hyperrotation
- L** internal hyperrotation

must be corrected.

Figures **M** and **N** show correct axial alignment of the implant.

Implantation: Rotational Knee Prosthesis

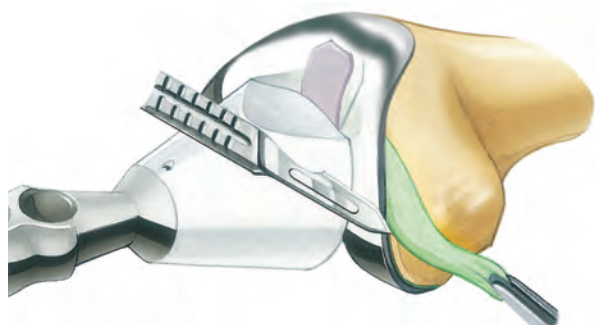

33

Once it has been verified that the implant is correctly positioned, the components are individually cemented in place. When using cemented modular stems with a length of 120 mm, it is recommended that the femoral components are usually implanted in around 80 g bone cement. The use of longer cemented modular stems requires a correspondingly larger amount of bone cement. Excess cement at the sides is removed.

When cementless modular stems are used, the femoral joint portion must be anchored with bone cement.

34

The plastic strip that protects the joint mechanism from the entry of cement is removed. The strip should be pulled posteriorly.

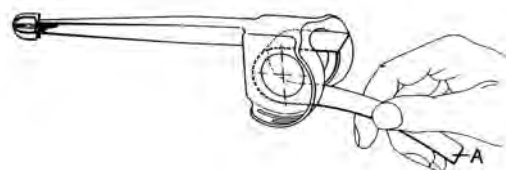
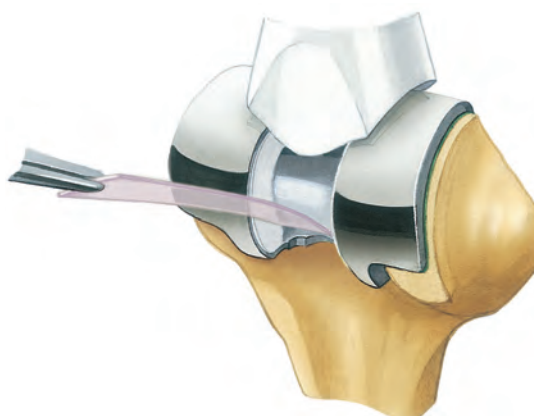

Implantation: Rotational Knee Prosthesis



Trial Screw
(flattened screw
head)

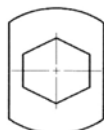

35

Before the tibial component is cemented with at least 40 g of cement, when cemented modular stems with a length of 135 mm are used, the tibial canal is sealed with a bone plug. The use of longer cemented modular stems requires a correspondingly larger amount of bone cement. Note the marked rotational position when aligning the implant. When cementless modular stems are used, the tibial joint portion must be anchored with bone cement.

Caution!

The tibial component may only be cemented without the polyethylene plateau removed where the trial screw has been inserted to a maximum depth. To remove the polyethylene plateau, the trial screw is removed and the plateau taken off of the metal tibial tray using the tibial plateau introducer. Subsequently, the trial screw is reintroduced until it stops in the metal plateau. **This is necessary to prevent cement from entering the threaded hole in the metal plateau.** Excess cement is removed.

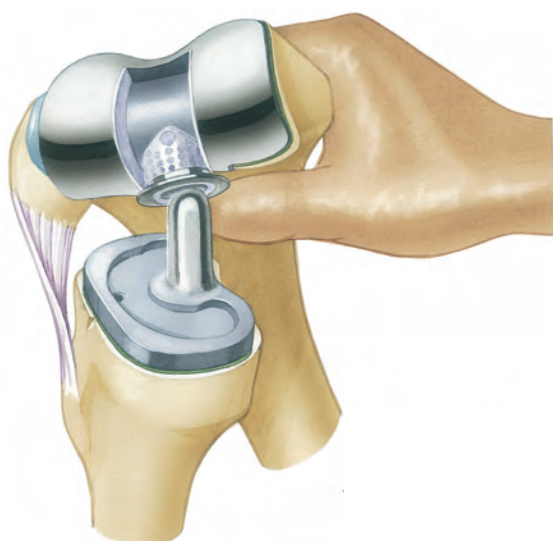

36

Before the cemented components are fitted together, the polyethylene plateau still has to be removed from the tibial metal tray. With the knee flexed, the femoral component is inserted onto the pin of the tibial component.

Implantation: Rotational Knee Prosthesis

37

To insert the polyethylene tibial plateau, the femoral component is lifted slightly. The tibial plateau is then inserted from an interior direction between the proximal and distal component of the prosthesis (O). Care should be taken to ensure that the chamber of the plastic plateau merges with the flange of the femoral component, and that the dovetail recess on the underside of the plastic plateau snaps into the marginal groove on the metal tibial tray (P).

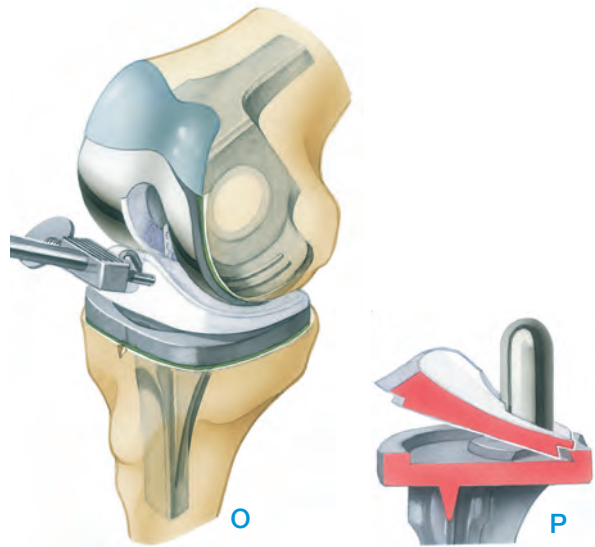

38

The polyethylene plateau is secured in place on the metal tibial tray with the self-locking fixation screw.

Caution!

The self-locking fixation screw may only be used during the final assembly of the plateau. Loosening the fixation screw destroys the screw retention system in the polyethylene plateau, and a new plateau must then be inserted.

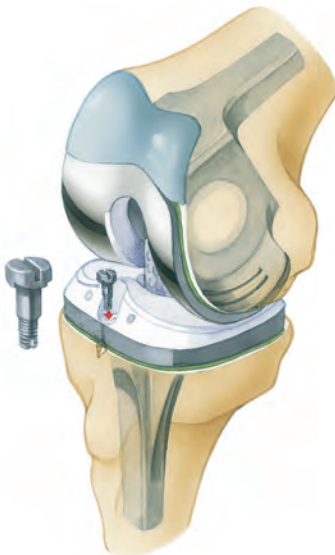

Self-locking Screw
(round screw head)

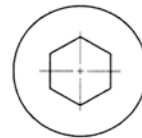

39

The implanted rotational knee prosthesis should allow up to 90° of flexion, depending on the soft tissue structures. In extension, a resilient extension impairment of approximately 5° is optimal. This extension impairment helps to ensure secure contact between the two prosthesis components.

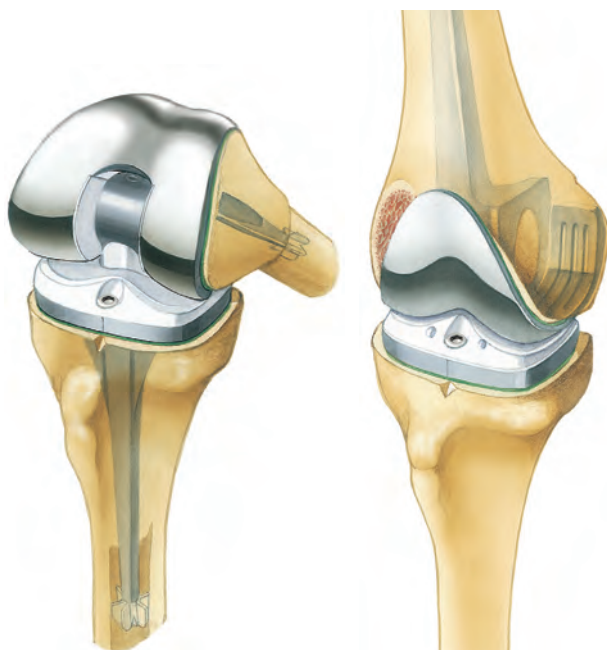

Implantation: Hinge Knee Prosthesis

The preparation of the osseous implant position is exactly the same as for the rotational variant. With regards to instruments, the complementary instrument set for the Endo-Model Total Hinge Knee Joint Prosthesis is required.

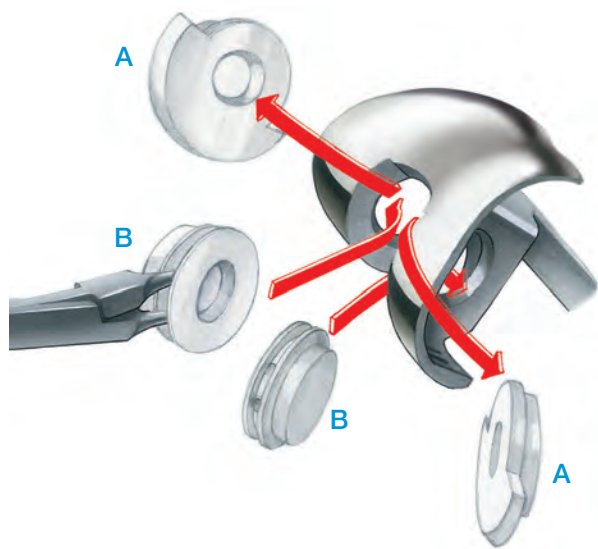

01

After the femur has been prepared to receive the femoral component, the polyethylene bearings (A), which are supplied assembled, are removed from the box of the femoral component and replaced with trial bearings (B). This takes place with special applying forceps (C).

Later, the trial bearings are replaced with the final bearings.



02

The introducer (D) is inserted into the femoral component. The drill guide must lie medially. The cylindrical portion of the shank of the introducer, opposite the drill guide, is first inserted into the medial bearing. Once the moveable spacer on the shaft of the instrument has been inserted into the intracondylar opening, the introducer is locked in the box of the femoral component by tightening the knurled-head screw (E).

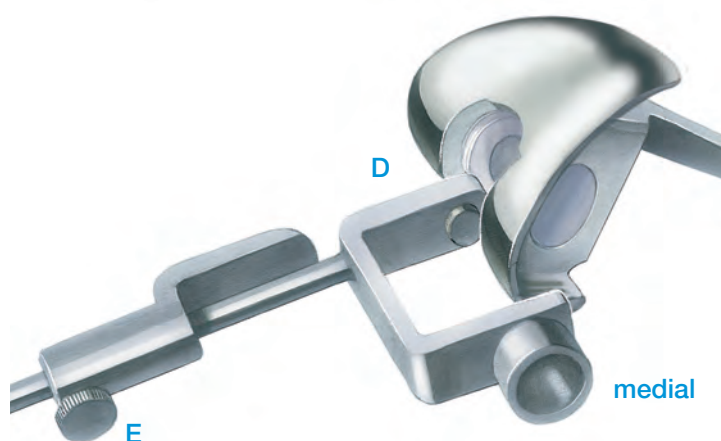

Implantation: Hinge Knee Prosthesis

03

A cylinder of bone is placed as a cement restrictor to seal the end of the femoral canal and the femoral component is implanted with at least 80 g of bone cement.

After the bone cement has hardened, a cylinder of bone is harvested from the medial condyle with the trephine and removed from the reamer for use later on in the procedure.



04

The tibial trial component is advanced into the prepared tibial canal with the introducer.



Implantation: Hinge Knee Prosthesis

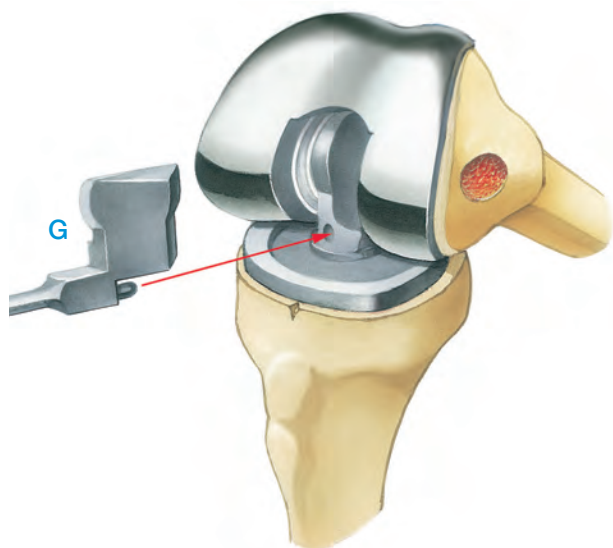

05

The upper and lower prosthetic components are connected. The pin (F) on the coupling of the tibial trial component is introduced into the lateral trial bearing and locked with the coupling jig (G).

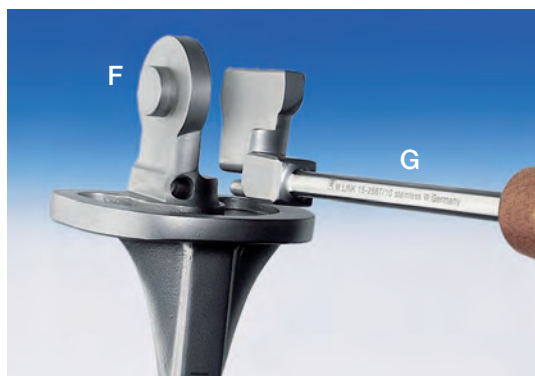

06

Correct location of the prosthesis components with respect to axial alignment, rotation, and sufficient extension and flexion should be verified. In certain cases, additional tibial resection may be required or a spacer should be used.

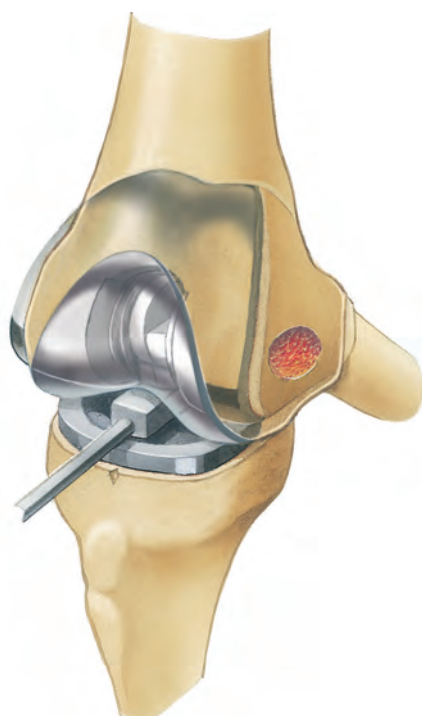

Implantation: Hinge Knee Prosthesis

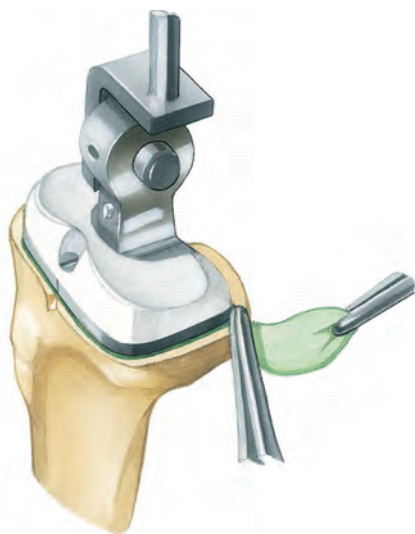

07

The tibial component is implanted with at least 40g of bone cement. Correct rotation is maintained with the introducer (H) while distal pressure is applied to the implant.



08

Finally, the trial bearings are replaced with the final bearings using the applying forceps (I).

Caution!

The open bearing must be placed medially, as the prosthesis axle is introduced medially.

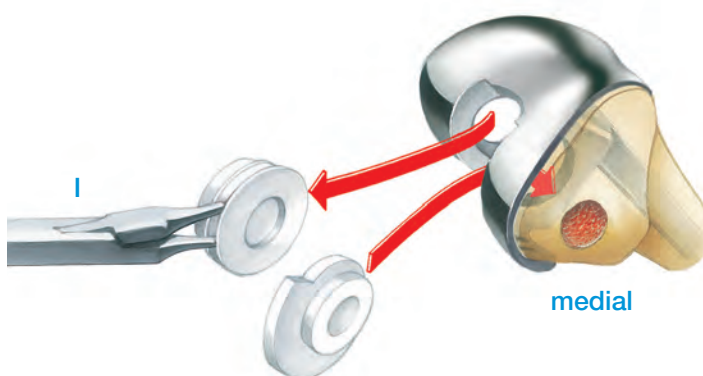

Implantation: Hinge Knee Prosthesis



09

The tibial component is introduced into the femoral component and is adjusted with the trial axle (J). A trial run is carried out. The upper and lower parts of the prosthesis are then sealed with the final prosthesis axle (K), which is mounted on the threaded rod (L). A set screw firmly screwed into the screw hole of the axle (M) ensures the axial position.

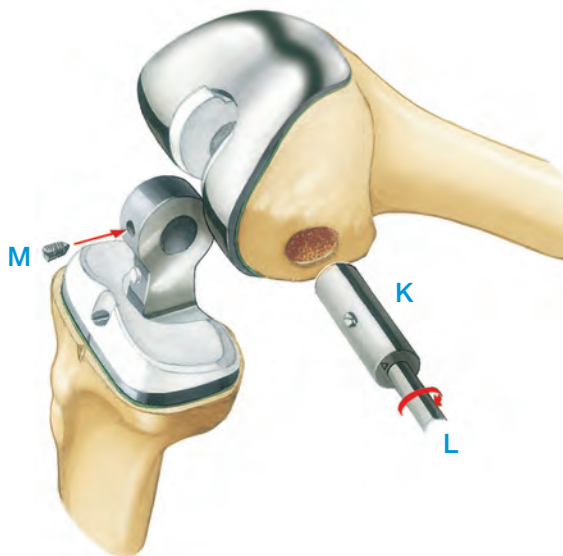

10

In order to prevent loosening of the screw, the terminal screw hole must be sealed over the set screw with some bone cement. The milled bone cylinder is introduced into the medial femoral condyle again.

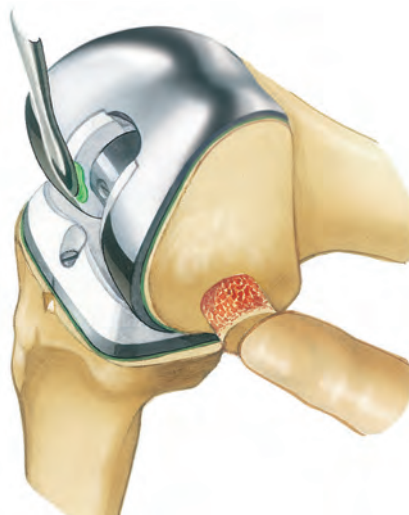

Implantation: Hinge Knee Prosthesis

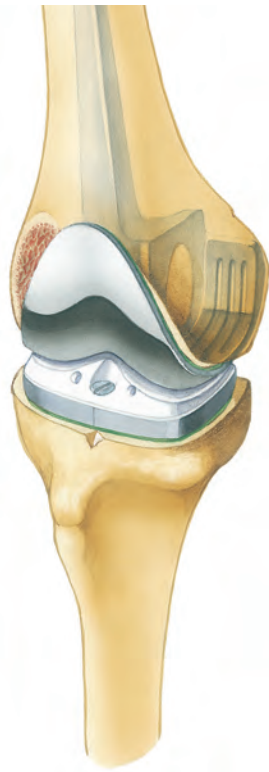

11

Completely implanted
Endo-Model Hinge Knee Prosthesis.

15-2599/05

X-ray Template for Endo-Model–M
 Modular Knee Prosthesis System,
 including modular stem extensions,
 110% actual size, 1 set of 9 sheets

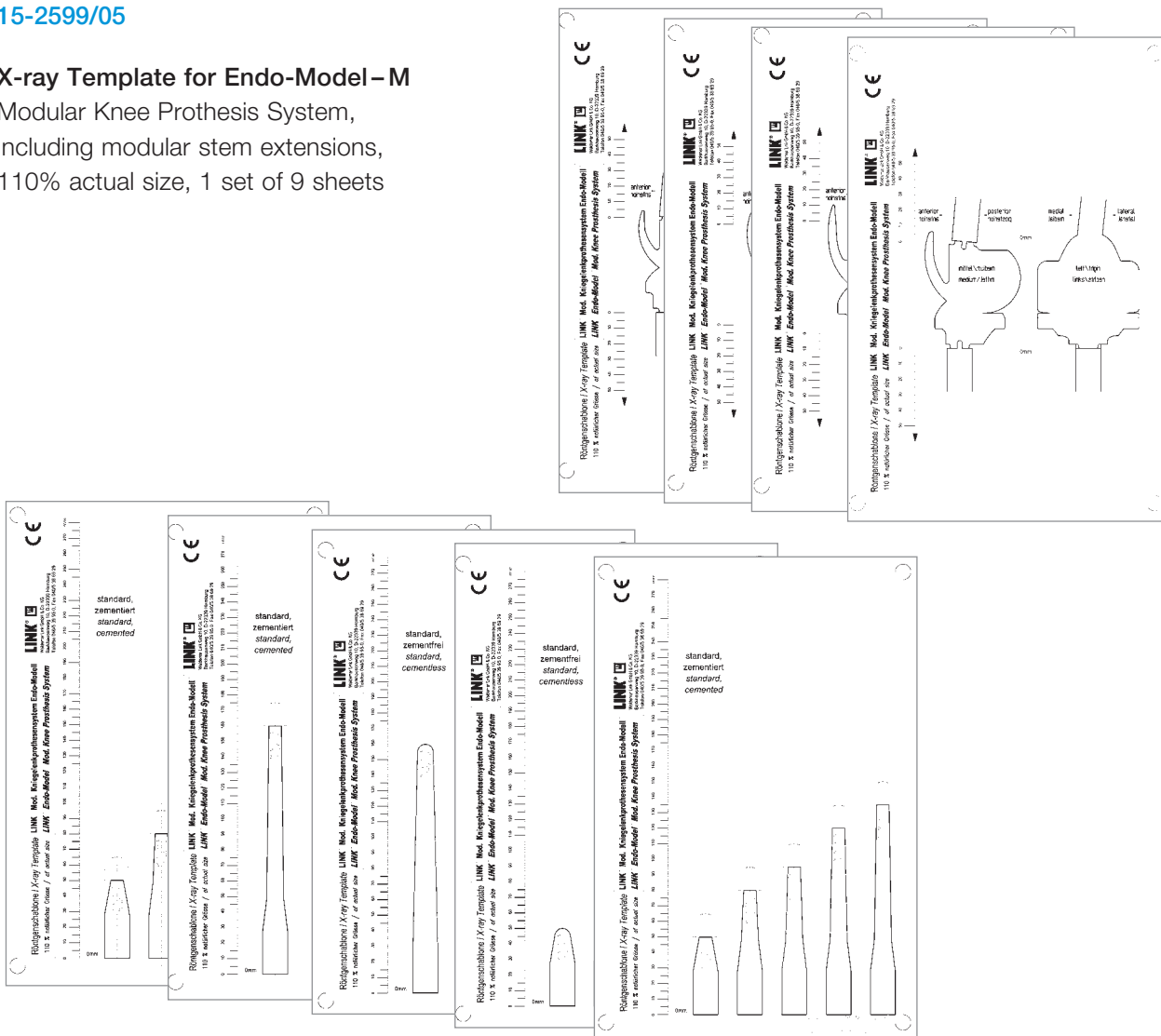



Further Information about:

Endo-Model – M
Modular Knee Prosthesis System with
Segmental Bone Replacement Components
Implants & Instruments

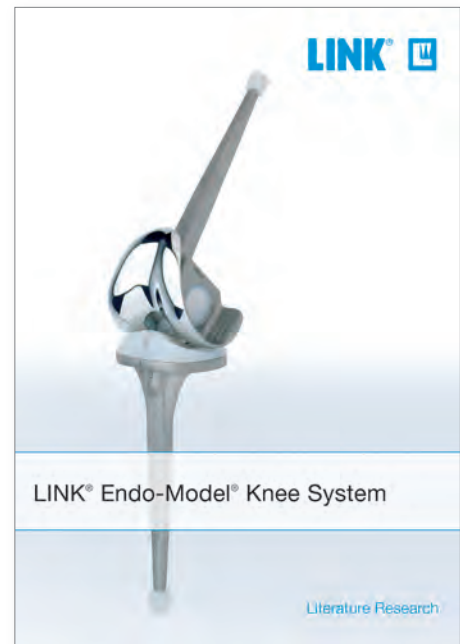

Endo-Model
Rotational and
Hinge Knee Prosthesis
Literature Research



LINK PorEx Technology
(TiNbN = Titanium Niobium Nitride)
for metal sensitive patients,
Materials & Surface Modification



For more information please register for our LINK Media Library (linkorthopaedics.com)

- E. Engelbrecht, A. Siegel, J. Röttger, and Prof. H. W. Buchholz*
Statistics of Total Knee Replacement: Partial and Total Knee Replacement, Design St. Georg
Journal of Clinical Orthopaedics, 1976, No. 120, pp 54-64 (K3)
- E. Engelbrecht, E. Nieder, E. Strickle, A. Keller
Intrakondyläre Kniegelenkendoprothese mit Rotationsmöglichkeit – ENDO-MODELL®
CHIRURG 52: 368-375 (1981) (K1)
- R. Dederich und L. Wolf
Kniegelenkprothesen-Nachuntersuchungsergebnisse
Unfallheilkunde (1982) 85:359-368 (K2)
- J. Röttger, K. Heinert
Die Knieendoprothesensysteme (Schlitten- und Scharnierprinzip). Beobachtungen und Ergebnisse nach 10 Jahren Erfahrung mit über 3700 Operationen.
Z. Orthop. 122(1984) 818-826 (K17)
- E. Nieder, E. Engelbrecht, A. Keller
Totale intrakondyläre Scharniergelenkendoprothese mit Rotationsmöglichkeit – Endo-Modell®
Sonderdruck aus Heft 5: Orthopädische Praxis, 1987, 23. Jahrgang, Seite 402-412 (K34)
- K. Heinert, E. Engelbrecht
Total Knee Replacement - Experience with a Surface and Total Knee Replacement: Further Development of the Model St. Georg®. 2400 Sledges and Hinges
*Proceedings of the International Symposium on Total Knee Replacement, May 19-20, 1987, Nagoya, Japan
Springer Verlag., Berlin Heidelberg, New York Tokyo (1987), pp 257-273 (K53)*
- E. Engelbrecht, M.D.
The Tibial Rotating Knee Prosthesis "Endo" Model: Surg. Technique
The Journal of Orthopaedic Surgical Techniques, Volume 3, Number 2, 1987 (K36)
- K. Heinert, E. Engelbrecht
Langzeitvergleich der Knie-Endoprothesensysteme St. Georg® 10-Jahres-Überlebensraten von 2236 Schlitten- und Scharnier-Endoprothesen
Der Chirurg (1988) 59:755-762 (K38)
- F. Madsen, P. Kjarsgaard-Andersen, M. Juhl, O. Sneppen
A Custom-Made Prosthesis for the Treatment of Supracondylar Femoral Fractures after Total Knee Arthroplasty: Report of Four Cases
Journal of Orthopaedic Trauma, Vol. 3, No. 4, pp. 333-337, 1989 (K42)
- E. Nieder
Schlittenprothese, Rotationsknie und Scharnierprothese Modell St. Georg® und Endo-Modell®. Differentialtherapie in der primären Kniegelenkalloarthroplastik
Orthopäde (1991) 20:170-180 (K45)
- G. von Förster, D. Klüber und U. Käbler
Mittel- bis langfristige Ergebnisse nach Behandlung von 118 periprothetischen Infektionen nach Kniegelenkersatz durch einzeitige Austauschoperationen
Orthopäde(1991) 20: 244-252 (K46)
- Adolph V. Lombardi, Jr, Thomas H. Mallory, Robert W. Eberle, and Joanne B. Adams
Results of Revision Total Knee Arthroplasty Using Constrained Prostheses
Seminars in Arthroplasty, Vol 7, No. 4 (October), 1996: pp 349-355
- E. Engelbrecht, E. Nieder, D. Klüber
Reconstruction of the Knee - Ten to Twenty Years of Knee Arthroplasty at the Endo-Klinik: A Report on the Long-term Follow-up of the St. Georg® Hinge and the Medium-term Follow-up of the Rotating Knee Endo-Model®
Springer Verlag: Tokyo, Berlin, Heidelberg, New York (1997) (K57)
- E. Nieder
Revisionsalloarthroplastik des Kniegelenks
*Sonderausgabe aus: Orthopädische Operationslehre, Band II/1: Becken und untere Extremität
Herausgegeben von R. Bauer, F. Kerschbaumer und S. Poisel*
- F. Alt, U. Sonnekalb, N. Walker
Unikondyläre Schlittenprothese versus scharniergeführte Totalendoprothesen des Kniegelenkes
Orthopädische Praxis 1/98, 34. Jahrgang, Seite 20-24, 1998 (K61)
- A. V. Lombardi, T. H. Mallory, R. E. Eberle, J. B. Adams
Rotating Hinge Prosthesis in Revision Total Knee Arthroplasty: Indications and Results
A Reprint from Surgical Technology International VI, 1998 (K55)
- E. Nieder, G.W. Baars, A. Keller
Totaler Tibia-Ersatz Endo-Modell®
Orthopädie Aktuell: Nr. 5/1998, LINK News (K60)
- S. Schill, H. Thabe
Die periprothetische Knieinfektion – Therapiekonzept, Wertigkeit und mittelfristige Ergebnisse
Aktuelle Rheumatologie, Heft 5, 24. Jahrgang, 1999, pp 153-160 (K70)
- G.W. Baars
Knieendoprothetik: Das optimale Implantat für jeweilige Indikation finden
Orthopäde 2000 (Suppl1) 29: S1-2
- M. Zinck, R. Sellkau
Rotationsknieprothese Endo-Modell®- Geführter Oberflächenersatz mit Sti(e)
Orthopäde 2000 (Suppl1) 29: S 38-42
- M. Crowa, E. Cenna, C. Olivero
Rotating knee prosthesis – Surface or hinge replacement?
Orthopäde 2000 (Suppl1) 29: S 43-44
- J-N. Argenson, J M. Aubaniac
Total Knee arthroplasty in femorotibial instability
Orthopäde 2000.29:S 45-47, Springer Verlag 2000 (K72)
- M. von Knoch, R. Brocks, C. Siegmüller, G. Ribaric, L. Leupolt, G. von Förster
Knieflexion nach Rotationsknieendoprothese
Z. Orthop 2000; 138: 66-68 (K71)
- R.E. Windsor, K. Steinbrink
Controversies in Total Knee Replacement Two-stage exchange is the optimal treatment for an infected total knee replacement
Oxford University Press 2001 (K78)
- Thomas Nau, MD, E. Pfelegerl, MD, J. Erhart, MD, and V. Vecsei, MD
Primary Total Knee Arthroplasty for Periarticular Fractures
The Journal of Arthroplasty, Vol 18, No 8, 2003 (K82)
- G. Petrou, H. Petrou, C. Tilkeridis, T. Stavrakis, T. Kapetsis, N. Kremmidas, M. Gavras
Medium-term results with a primary cemented rotating-hinge total knee replacement
A 7-TO 15-YEAR FOLLOW-UP
J Bone Joint Surg (Br), 2004; 86-B :813-17 (K84)
- M.R. Utting, J.H. Newman
Customised hinged knee replacement as a salvage procedure for failed total knee arthroplasty
The Knee 11 (2004) 475-479 (K86)
- Nayana Joshi, Antonio Navarro-Quilis
Is There a Place for Rotating-Hinge Arthroplasty in Knee Revision Surgery for Aseptic Loosening?
The Journal of Arthroplasty 2008; 23(8):1204-1210 (K94)
- M. Napp, M. Frank, M. Witt
Pathologische Fraktur des distalen Femurs bei Knie-TEP
Der Orthopäde, Band 38, Heft 10, Oktober 2009 (K96)
- Dae Kyung Bae, Sang Jun Song, Kyoung Ho Yoon, Jung Ho Noh
Long-Term Outcome of Total Knee Arthroplasty in Charcot Joint: A 10- to 22- Year Follow-Up
The Journal of Arthroplasty 2009; 24(8):1152-1156 (K98)

Please note the following regarding the use of our implants:

1. Choosing the right implant is very important.

The size and shape of the human bone determines the size and shape of the implant and also limits the load capacity. Implants are not designed to withstand unlimited physical stress. Demands should not exceed normal functional loads.

2. Correct handling of the implant is very important.

Under no circumstances should the shape of a finished implant be altered, as this shortens its life span. Our implants must not be combined with implants from other manufacturers. The instruments indicated in the Surgical Technique must be used to ensure safe implantation of the components.

3. Implants must not be reused.

Implants are supplied sterile and are intended for single use only. Used implants must not be used again.

4. After-treatment is also very important.

The patient must be informed of the limitations of the implant. The load capacity of an implant cannot compare with that of healthy bone!

5. Unless otherwise indicated, implants are supplied in sterile packaging.

Note the following conditions for storage of packaged implants:

- Avoid extreme or sudden changes in temperature.
- Sterile implants in their original, intact protective packaging may be stored in permanent buildings up until the "Use by" date indicated on the packaging.
- They must not be exposed to frost, dampness or direct sunlight, or mechanical damage.
- Implants may be stored in their original packaging for up to 5 years after the date of manufacture. The "Use by" date is indicated on the product label.
- Do not use an implant if the packaging is damaged.

6. Traceability is important.

Please use the documentation stickers provided to ensure traceability.

7. Further information on the material composition is available on request from the manufacturer.

Follow the instructions for use!

Waldemar Link GmbH & Co. KG, Hamburg

All content in this catalog, including text, pictures and data, is protected by law. Every instance of use, whether in part or in whole and which is not permitted by law, is subject to our prior consent. In particular, this applies to the reproduction, editing, translation, publishing, saving, processing, or passing on of content stored in databases or other electronic media and systems, in any manner or form. The information in the catalogs is solely intended to describe the products and does not constitute a guarantee.

The Surgical Technique described has been written to the best of our knowledge and belief, but it does not relieve the surgeon of his/her responsibility to duly consider the particularities of each individual case.

Products shown in this document may not be available in your country. The product availability is subject to the approval and/or registration regulations of the respective country. Please contact Waldemar Link GmbH & Co. KG if you have questions about the availability of LINK products in your country.

Waldemar Link GmbH & Co. KG and/or other corporate affiliated entities own, use or have applied for the following trademarks in many jurisdictions: LINK, BiMobile, SP II, Modell Lubinus, E-Dur, EndoDur, T.O.P. II, BetaCup, CombiCup PF, CombiCup SC, CombiCup R, MobileLink, C.F.P., LCU, SP-CL, LCP, MIT-H, Endo-Model, Endo-Model SL, MP, MEGASYSTEM-C, GEMINI SL, SPAR-K, LCK, HX, TiCaP, X-LINKed, PorAg, LINK PorEx, BiPorEx, PorEx-Z, TrabecuLink, Tilastan, customLINK, RescueSleeve, Stactip, VACUCAST.

Other trademarks and trade names may be used in this document to refer to either the entities claiming the marks and/or names or their products and are the property of their respective owners.

