







C.F.P. Hip Prosthesis System

CE 0482

Explanation of Pictograms			
	Manufacturer		Item number
	Material (number)		Product meets the applicable requirements, which are regulated in the EU harmonization legislation for the affixing of the CE marking.

C.F.P. Hip Prosthesis System

System Description

- 02 Bioharmony in Total Hip Replacement

Surgical Technique

- 03 Preoperative Planning
- 04 Surgical Approaches

Implants

- 14 Prosthesis Stems
- 15 Exchangeable Collars

Instruments

- 16 Instrument Set for LINK C.F.P. Prosthesis Stems
- 21 Additional Instruments

Accessories

- 22 X-ray Templates
Instructions for Cleaning and Maintenance

- 23 **Literature**

- 24 **Indications/Contraindications**

Important Information

Bioharmony in Total Hip Replacement

The C.F.P. hip prosthesis stem allows a neck-preserving cementless implantation. It was specifically developed for young, active patients, who are typically expected to have an increased average rate of aseptic loosening with a conventional hip prosthesis, due to their long life expectancy.

Taking into consideration principles of biomechanical loading and anchoring, correlating to hip anatomy and physiology, the C.F.P. hip system achieves a stable, stress-resistant anchoring of the prosthesis. At the same time, the partial preservation of the femoral neck promotes favorable conditions for later interventions.

C.F.P. Hip Prosthesis Stem

- 98,3% survival rate after 11 years ¹
- Partial preservation of the Collum Femoris
- Anatomical stem design reflects the natural anatomy of the femur
- Ribbed profile for high primary stability ²
- Different stem curvatures promote support of the stem at the medial cortex
- Collar allows reintroduction of physiological loads into the femur ^{3,4}
- Available with HX (CaP) coating, to promote osteoconduction and improve secondary stability ⁵
- Made of **TiZotan** (Ti6Al4V)

Preoperative Planning

The aim in preoperative planning is to establish the approximate size of implant required and the optimal position in which to place it. Careful planning helps surgeons to foresee and avoid surgical problems.

For the best possible results the appropriate implant should be selected using C.F.P. X-ray templates which are available at a scale of 1.1:1. When used in combination with recent pelvic X-rays (A/P and M/L views) these templates serve as a useful aid in planning surgical procedure and determining implant size.

In planning the resection level, the femoral neck must be considered along with centre of rotation and leg length. The femoral neck should remain as intact as possible so that the original anatomy can be reconstructed.

The choice of implant should ensure that the greatest possible length of hip stem lies along the Adam's Bow. Stems are available with two different curvatures, curve A and curve B, for this purpose.

The distal tip of the prosthesis should be oriented along the centre of the medullary canal and should not have any distal cortical contact.

Surgical Approaches

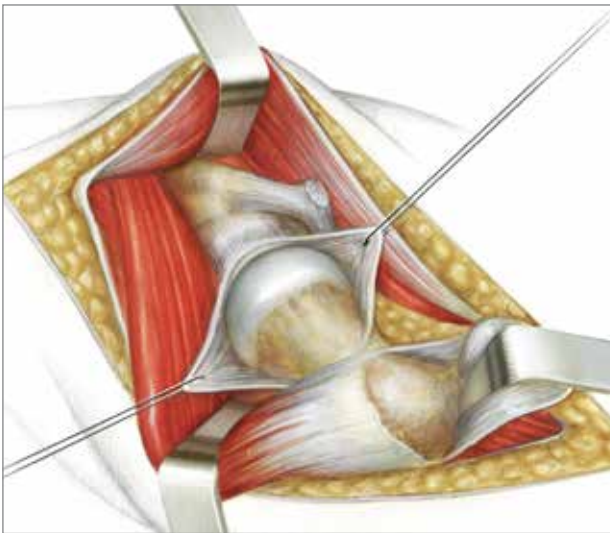

A: **Watson Jones**

The choice depends on the surgeon's experience and his/her decision based on the individual situation.

The following approaches are common:

- antero-lateral - **Watson Jones** (A)
- lateral - **Hardinge** (B)
- postero-lateral - **Moore** (C)

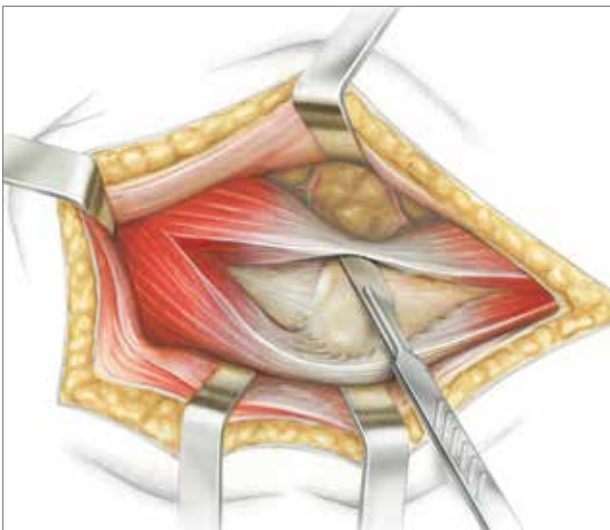

B: **Hardinge**

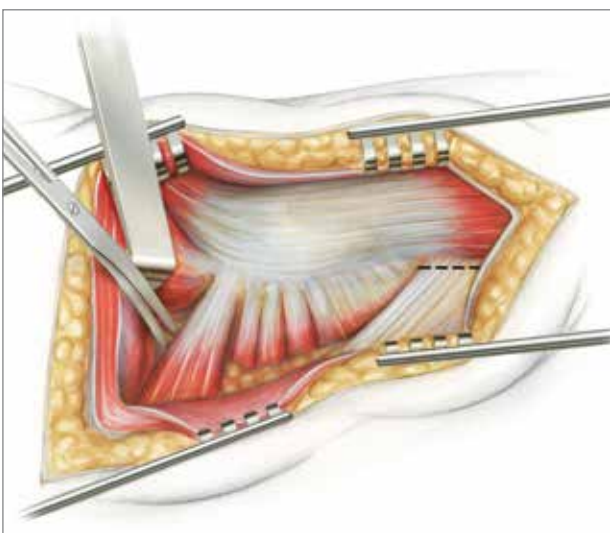
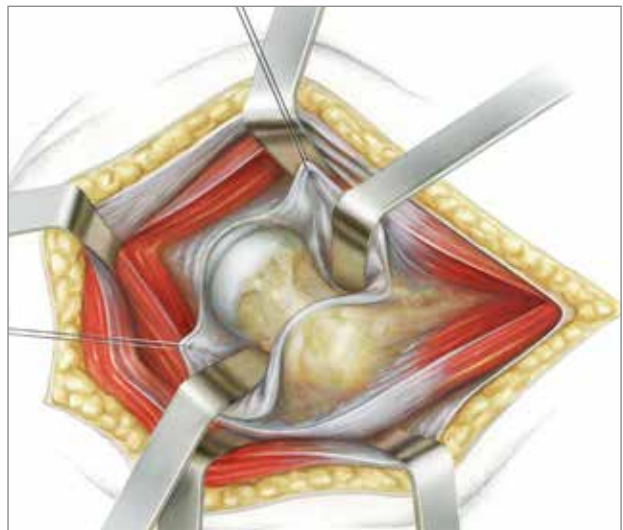

C: **Moore**

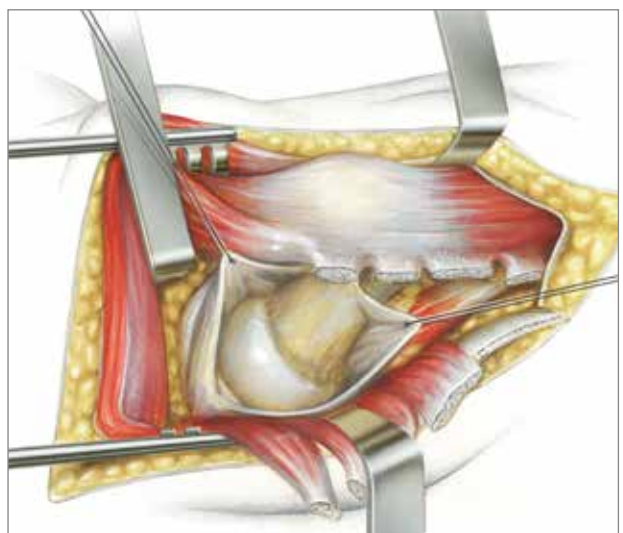



Fig. 1

Dislocation of Femoral Head

After dislocation of the femoral head the femoral neck and the proximal rim of both trochanters are exposed and existing osteophytes of the femoral head removed.

Fig. 2 and 3

Femoral Head Resection

During preoperative planning the osteotomy site is determined by applying tangents as shown in Fig. 3.

The line of the resection on the isthmus corresponds to the line connecting the intersection points of the tangents. The distance from the base of the major trochanter is usually 1.5 cm.

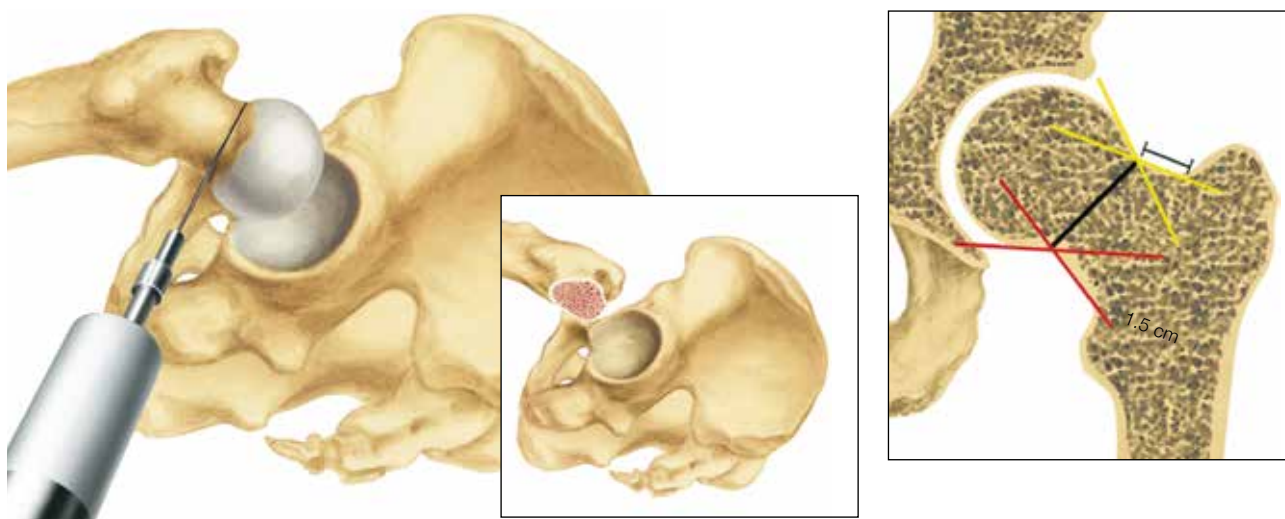
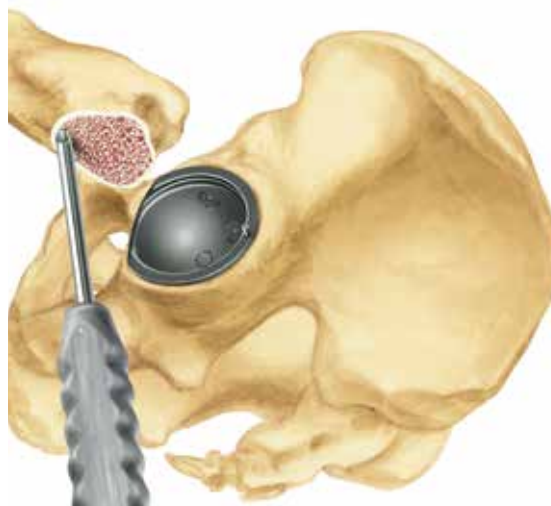
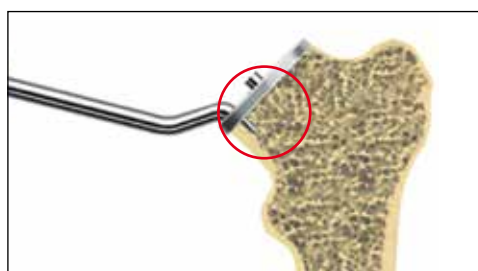

Fig. 3

Preparation of Proximal Femur

Using a trocar awl a small hole is made in the resected femoral neck, as far medially as possible, to accommodate the pin of the guide.



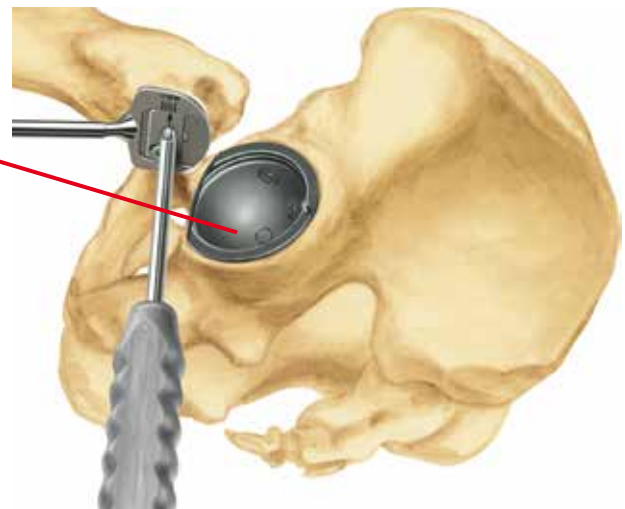
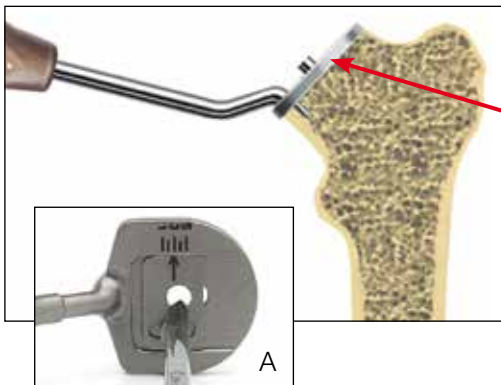

Fig. 4

Targeting opening of femoral canal

The guide is adjusted to the planned prosthesis size (A) and placed on the resection site taking the premarked hole into consideration. The trocar awl is used to site the opening of the medullary cavity.



Fig. 5

Opening of Femoral Canal

The femoral canal is opened using a curved bone curette.



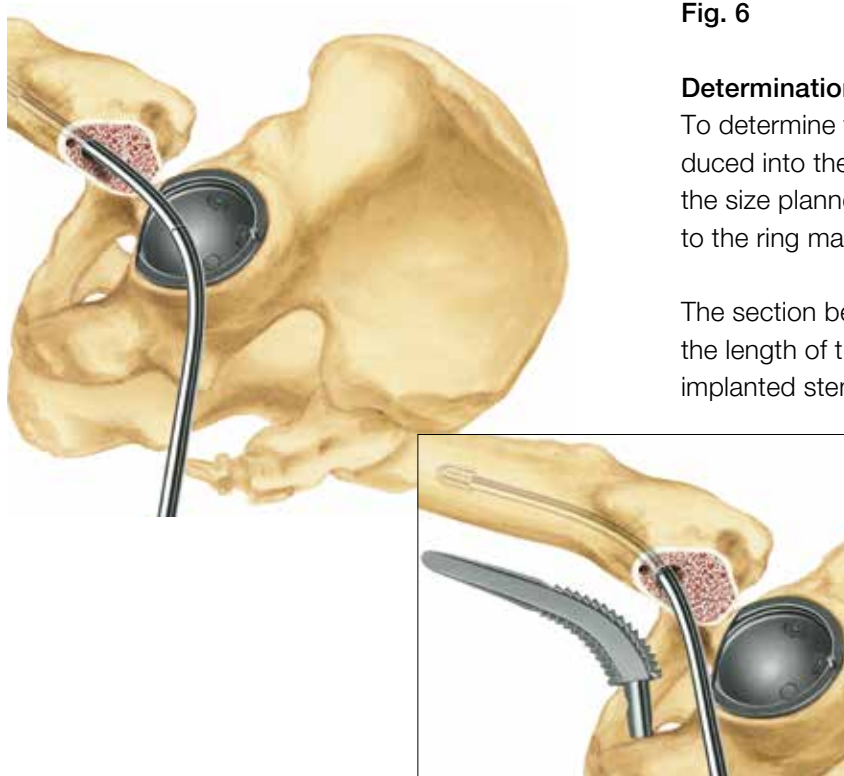

Fig. 6

Determination of Stem Size

To determine the stem size a curved probe is introduced into the canal starting with one size below the size planned. Each curved probe is inserted up to the ring mark.

The section below to the ring mark corresponds to the length of the bone compressor and of the final implanted stem.



Fig. 7

Placing of Compressor

Finally the femoral canal is prepared for seating of the prosthesis stem by compressing the cancellous bone with the bone compressor. The choice of bone compressor depends on the stem curvature determined at the planning stage and the size indicated by the curved probe.

Initially a compressor should be used which is one or two sizes smaller than the planned size of the final implant. At this stage it is important to ensure that the medial teeth of the compressor do not remove the cortical bone at the calcar bow.

When the smallest C.F.P. prosthesis stem is used preparation of the femoral canal with a smaller compressor is not necessary. In this case preparation of the femoral bone with a curved bone curette and the sizing olive is sufficient.

Fig. 8

Fitting of Compressor

The bone compressor is driven in below the resection level so that reaming with the calcar reamer produces a smooth surface on which the removable collar can be seated.



Attention:
To prevent the reamer from being damaged it must always be pushed as far as possible onto the guide pin before starting to ream.

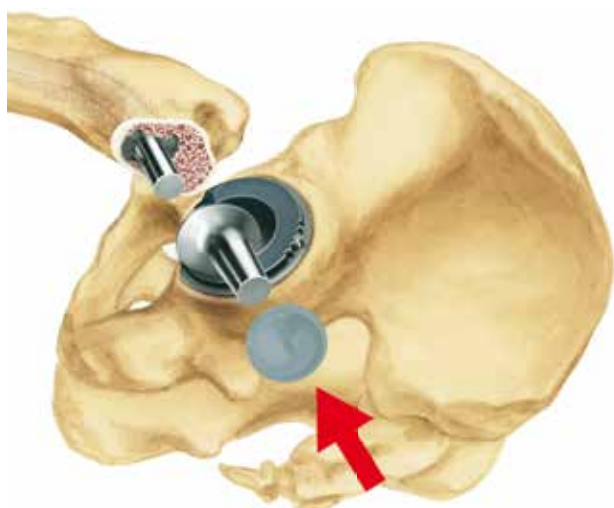

Fig. 9

Preparation of Trial Reduction

Trial neck (left or right and 117° or 126° CCD angle) and trial head are attached to the bone compressor in situ. The bone compressor now serves as a trial stem.



Fig. 10

Trial Reduction

The trial reduction indicates the correct position and the head-neck length.



Fig. 11

Implantation of Stem

The final C.F.P. stem is placed in the stem inserter. To prevent damage to the taper of the stem it is important to ensure that the inserter locks firmly onto the end face of the taper and holds the stem correctly beneath the taper. The C.F.P. stem is then inserted as far as possible into the femoral canal using the stem inserter.

The design of the C.F.P. stem incorporates the anatomical anteversion of the femoral neck. Adjustment of the anteversion, as performed when implanting straight stems, would lead to rotational malpositioning and must therefore be avoided.

Anteversion

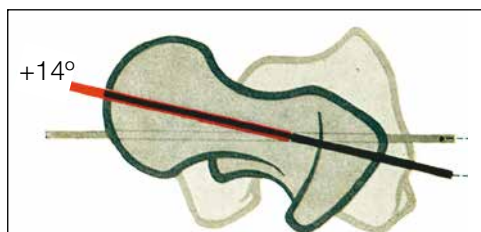



Note: LINK strongly recommends to not remove the collar. In case the surgeon does not follow this advice and the stem is implanted without collar, he/she has to make sure that the collar locking screw is removed as well.

Fig. 12

Driving in Stem

Placing the tip of the impactor into the recess on the lateral collar the C.F.P. stem can be driven home into the canal. Before it is finally driven home the collar may be removed in order to insert additional bone into the grooves.

The fixation screw on the collar must then be firmly tightened anticlockwise.



Fig. 13

Final Trial Reduction with Trial Head

As a precaution, a final trial run is performed using colored plastic trial heads.

Fig. 14

Positioning of the Prosthesis Head

The final prosthesis head is then mounted on the carefully cleaned taper of the stem and fixed with a light blow on the impactor.

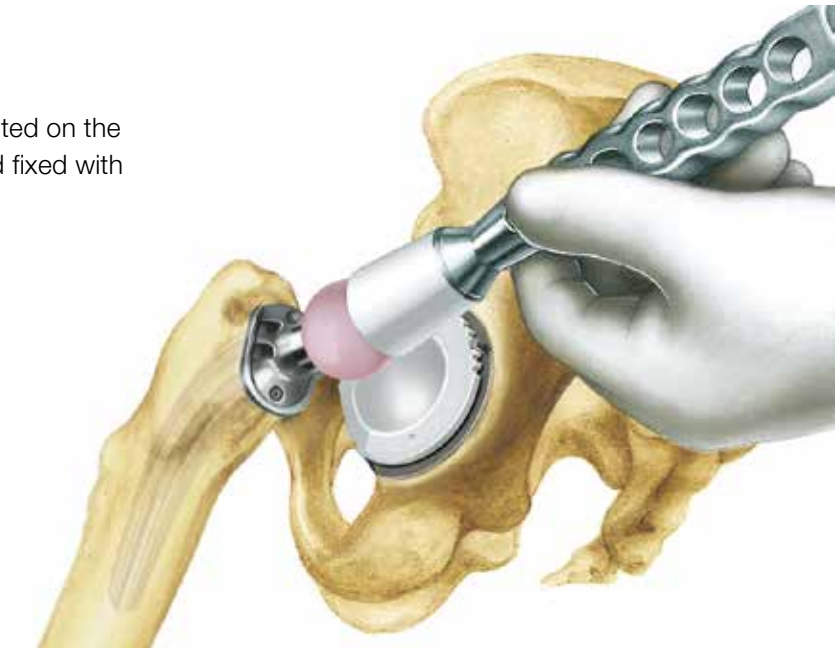

Fig. 15 and 16

The C.F.P. Prosthesis Stem in situ.

Final trial reduction with permanent implant components.



Prosthesis Stems, cementless, taper 12/14 mm

MAT Tizotan with HX Coating (calcium phosphate)

HX coated



Curvature A (slight)				Curvature B (strong)	
CCD angle 117°	CCD angle 126°	HX coated		CCD angle 117°	CCD angle 126°
REF	REF	Size	Version	REF	REF
290-118/17	290-118/26	x-small	right	290-170/17	290-170/26
290-120/17	290-120/26	small	right	290-174/17	290-174/26
290-126/17	290-126/26	medium	right	290-178/17	290-178/26
	290-128/26	medium large	right		290-180/26
290-132/17	290-132/26	large	right	290-182/17	290-182/26
290-138/17	290-138/26	x-large	right	290-186/17	290-186/26
290-119/17	290-119/26	x-small	left	290-171/17	290-171/26
290-121/17	290-121/26	small	left	290-175/17	290-175/26
290-127/17	290-127/26	medium	left	290-179/17	290-179/26
	290-129/26	medium large	left		290-181/26
290-133/17	290-133/26	large	left	290-183/17	290-183/26
290-139/17	290-139/26	x-large	left	290-187/17	290-187/26

MAT Tizotan

microporous ≈ 70 μm roughness

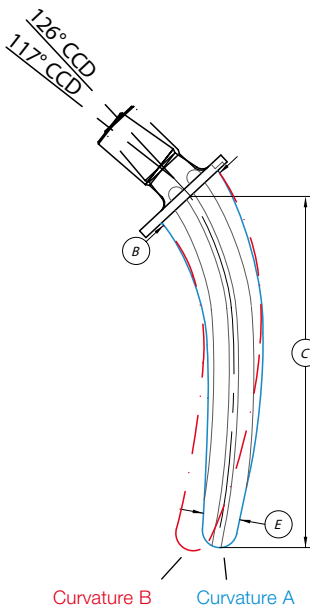

Curvature A (slight)				Curvature B (strong)	
CCD angle 117°	CCD angle 126°	microporous with 70 μm roughness		CCD angle 117°	CCD angle 126°
REF	REF	Size	Version	REF	REF
290-094/17	290-094/26	x-small	right	290-150/17	290-150/26
290-100/17	290-100/26	small	right	290-154/17	290-154/26
290-106/17	290-106/26	medium	right	290-158/17	290-158/26
	290-108/26	medium large	right		290-160/26
290-112/17	290-112/26	large	right	290-162/17	290-162/26
290-114/17	290-114/26	x-large	right	290-166/17	290-166/26
290-095/17	290-095/26	x-small	left	290-151/17	290-151/26
290-101/17	290-101/26	small	left	290-155/17	290-155/26
290-107/17	290-107/26	medium	left	290-159/17	290-159/26
	290-109/26	medium large	left		290-161/26
290-113/17	290-113/26	large	left	290-163/17	290-163/26
290-115/17	290-115/26	x-large	left	290-167/17	290-167/26

Curvature A or B			
Size	B [mm]	C [mm]	E [mm]
x-small	19.5	82	11
small	22	105	10
medium	24	115	11.5
medium large	25	120	12
large	26	125	13.5
x-large	28	135	15.5

Exchangeable Collars, cementless



All C.F.P. hip prostheses are supplied with a standard size collar.

MAT Unalloyed titanium and HX Coating (calcium phosphate)

REF	HX coated, for stem size	REF
Standard		Large
290-190/01	x-small	290-191/01
290-190/02	small	290-191/02
290-190/03	medium	290-191/03
290-190/13	medium large	290-191/13
290-190/04	large	290-191/04
290-190/05	x-large	290-191/05

MAT Unalloyed titanium

REF	microporous surface, 70 µm roughness, for stem size	REF
Standard		Large
290-192/01	x-small	290-193/01
290-192/02	small	290-193/02
290-192/03	medium	290-193/03
290-192/13	medium large	290-193/13
290-192/04	large	290-193/04
290-192/05	x-large	290-193/05

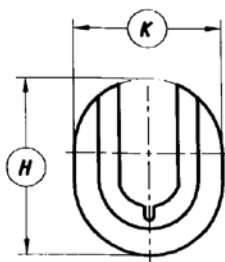

Standard		for stem size	Large	
H [mm]	K [mm]		H [mm]	K [mm]
32	26	x-small	36	29
34	28	small	38	31
36	30	medium	40	33
37	31	medium large	41	34
38	32	large	42	35
40	34	x-large	44	37

Instrument Set for LINK C.F.P. Prosthesis Stems



REF	Instrument set, complete (container 1 + 2)
291-020/16	Set complete in 2 standard containers N11 & N31, on 3 trays with product illustrations and storage inserts
05-2003/03	N31 standard container, empty , 575 x 275 x 170 mm
05-2001/03	N11 standard container, empty , 575 x 275 x 100 mm
291-021/07	Upper tray (container 1), empty, perforated stainless steel, 550 x 265 x 50 mm
291-023/06	Lower Tray (container 1), empty, perforated stainless steel, 550 x 265 x 50 mm
291-022/07	Tray (container 2), empty, perforated stainless steel, 550 x 265 x 50 mm

291-021/07 Upper Tray

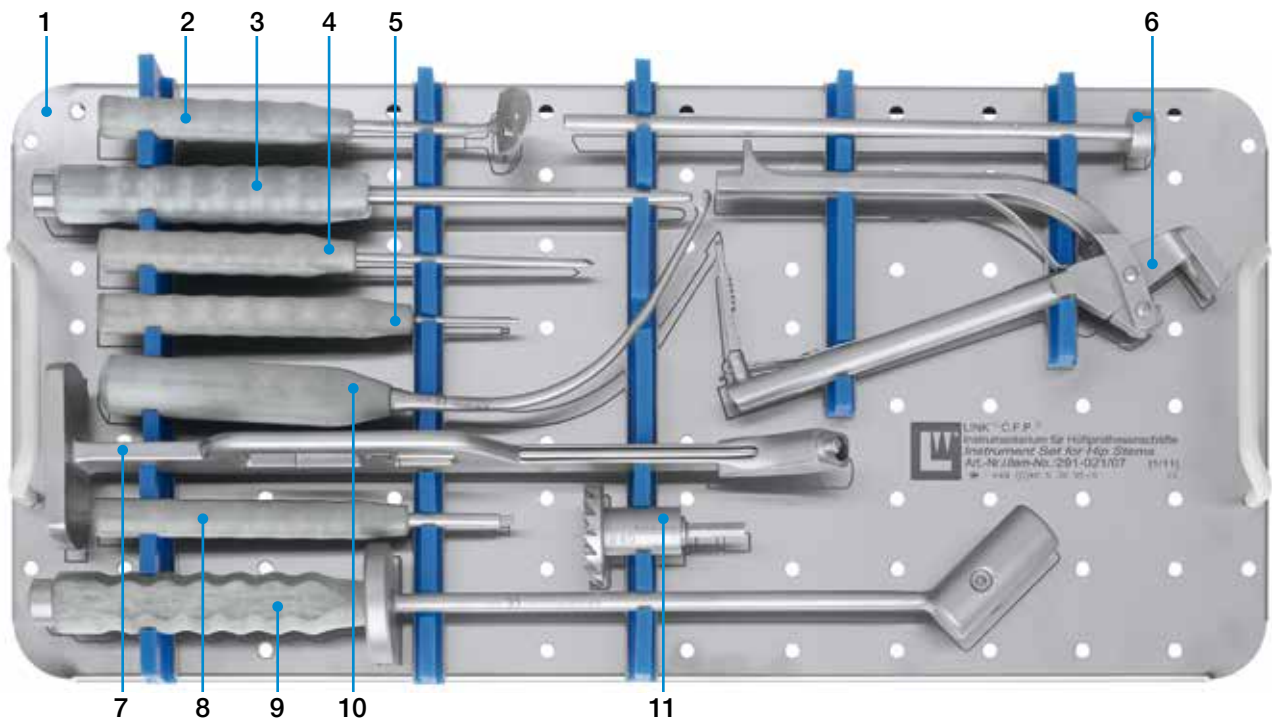

			Qty.
1	291-021/07	Upper tray (container 1), empty, perforated stainless steel, 550 x 265 x 50 mm	1
2	291-080	Guide to open femoral cavity, 180 mm	1
3	130-611	Impactor , 280 mm	1
4	291-081	Trocar awl , 200 mm	1
5	64-1181/06	Hex screwdriver , 175 mm, hex 2 mm	1
6	291-083/02	Stem inserter , 250 mm, 2 parts	1
7	130-393/60	Handle with quick coupling , 330 mm	1
8	130-609	Hex screwdriver , 175 mm, hex 4 mm	1
9	291-085	Stem extractor , 435 mm	1
10	291-082	Bone curette curved, to open femoral cavity, 260 mm	1
11	130-406/01A*	Calcar reamer Ø 40 mm, fitting for Jacobs Chuck, fitting optional*	1
	10-5371**	Hex screwdriver , 180 mm, hex 1.5 mm (**not included in instrument set)	1

*How to order: 131-406/01B = with Hudson fitting

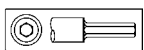

A
Jacobs Chuck



B
Hudson



C
Harris



D
AO



H
Zimmer

291-023/06 Lower Tray

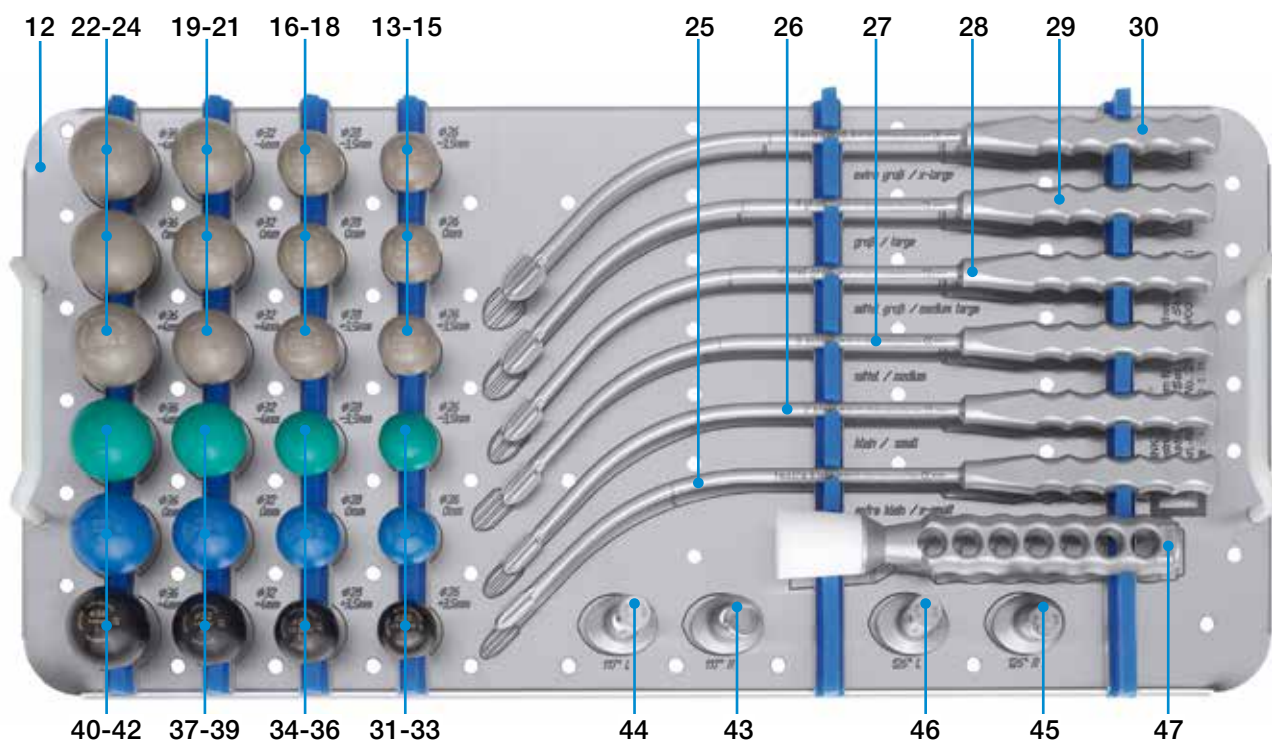

Qty.

12	291-023/06	Lower tray (container 1), empty, perforated stainless steel, 550 x 265 x 50 mm			1
Grey plastic trial heads with snap-fit for compressor cylinder					
	REF	Ø [mm]	Neck length	Neck length [mm]	Qty.
13	291-826/01	26	short	-3.5	1
14	291-826/02	26	medium	0	1
15	291-826/03	26	long	+3.5	1
16	291-828/01	28	short	-3.5	1
17	291-828/02	28	medium	0	1
18	291-828/03	28	long	+3.5	1
	291-828/04*	28	extra long	+10.5	1
19	291-832/01	32	short	-4	1
20	291-832/02	32	medium	0	1
21	291-832/03	32	long	+4	1
	291-832/04*	32	extra long	+8.5	1
	291-832/05*	32	extra long	+7	1
22	291-836/01	36	short	-4	1
23	291-836/02	36	medium	0	1
24	291-836/03	36	long	+4	1
	291-836/04*	36	extra long	+8	1
	291-840/01*	40	short	-4	1
	291-840/02*	40	medium	0	1
	291-840/03*	40	long	+4	1
	291-840/04*	40	extra long	+8	1

*On request

Curved probes with sizing olives, graduated, 300 mm						
REF	Size	For prosthesis stem			Qty.	
25	291-102/01	1	x-small			1
26	291-100/02	2	small			1
27	291-100/03	3	medium			1
28	291-100/35	35	medium large			1
29	291-100/04	4	large			1
30	291-100/05	5	x-large			1
Colored plastic trial heads, taper 12/14 mm						
REF	Ø [mm]	Neck length	Neck length [mm]	Color	Qty.	
31	131-926/01	26	short	-3.5	green	1
32	131-926/02	26	medium	0	blue	1
33	131-926/03	26	long	+3.5	black	1
34	131-928/01	28	short	-3.5	green	1
35	131-928/02	28	medium	0	blue	1
36	131-928/03	28	long	+3.5	black	1
	131-928/04*	28	extra long	+10.5	brown	1
37	131-932/01	32	short	-4	green	1
38	131-932/02	32	medium	0	blue	1
39	131-932/03	32	long	+4	black	1
	131-932/04*	32	extra long	+8.5	brown	1
	131-932/05*	32	extra long	+7	orange	1
40	131-936/01	36	short	-4	green	1
41	131-936/02	36	medium	0	blue	1
42	131-936/03	36	long	+4	black	1
	131-936/04*	36	extra long	+8	brown	1
	131-940/11*	40	short	-4	green	1
	131-940/12*	40	medium	0	blue	1
	131-940/13*	40	long	+4	black	1
	131-940/14*	40	extra long	+8	brown	1
Trial neck sections						
REF	CCD angle	Version			Qty.	
43	291-120/17	117°	right			1
44	291-121/17	117°	left			1
45	291-120/26	126°	right			1
46	291-121/26	126°	left			1
47	130-600	Driver for prosthesis heads with exchangeable plastic head, 170 mm			Qty. 1	



*On request

291-022/07 Tray

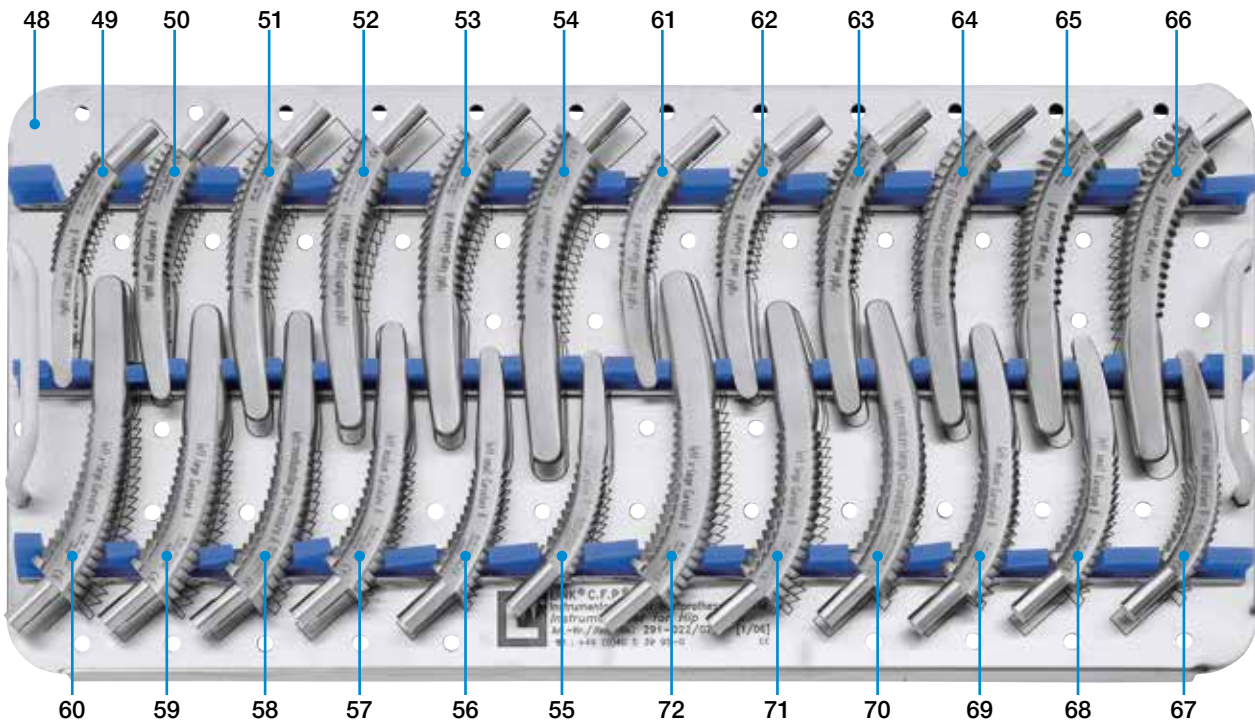

48	291-022/07	Tray (container 2), empty, perforated stainless steel, 550 x 265 x 50 mm				1 Qty.	
Bone compressors, curvature A							
REF		Size	Version	REF		Size	Version
49	291-200/03	x-small	right	55	291-200/04	x-small	left
50	291-201/01	small	right	56	291-201/02	small	left
51	291-202/01	medium	right	57	291-202/02	medium	left
52	291-202/11	medium large	right	58	291-202/12	medium large	left
53	291-203/01	large	right	59	291-203/02	large	left
54	291-204/01	x-large	right	60	291-204/02	x-large	left
Bone compressors, curvature B							
REF		Size	Version	REF		Size	Version
61	291-210/03	x-small	right	67	291-210/04	x-small	left
62	291-211/01	small	right	68	291-211/02	small	left
63	291-212/01	medium	right	69	291-212/02	medium	left
64	291-212/11	medium large	right	70	291-212/12	medium large	left
65	291-213/01	large	right	71	291-213/02	large	left
66	291-214/01	x-large	right	72	291-214/02	x-large	left

Additional Instruments

(not included in instrument set for C.F.P. Prosthesis Stems)



130-601
Replacement head for driver 130-600



130-165
Mallet
Ø 30 mm, 270 mm, 600 gram

130-393/15
Handle for rasp stems,
right hip, angled



130-393/25
Handle for rasp stems,
left hip, angled

X-ray Templates

X-ray templates for C.F.P. Prosthesis Stems, cementless (with neutral head-neck length), taper 12/14 mm, 110% actual size

Curvature A			
REF	Head Ø mm	CCD angle	Stem size
290-258/52	28, 32, 36, 40	117°	x-small, small, medium, large, x-large
290-258/32	28, 32, 36, 40	126°	x-small, small, medium, medium large, large, x-large
Curvature B			
REF	Head Ø mm	CCD angle	Stem size
290-259/52	28, 32, 36, 40	117°	x-small, small, medium, large, x-large
290-259/32	28, 32, 36, 40	126°	x-small, small, medium, medium large, large, x-large

Instructions for Cleaning and Maintenance

Specific instructions for instruments are available on request via E-mail: customer@linkhh.de

Literature

- 1 Kendoff, D., Citak, M., Egidy, C., O'Loughlin, P., & Gehrke, T. (2013). Eleven-year results of the anatomic coated CFP stem in primary total hip arthroplasty. *The Journal of Arthroplasty*, 28(6), pp. 1047-1051.
- 2 Pipino, F., Keller, A. (2006). Tissue-sparing surgery: 25 years' experience with femoral neck preserving hip arthroplasty. *Journal of Orthopaedics and Traumatology*, 7(1), pp. 36-41.
- 3 Prendergast, P., & Taylor, D. (1990). Stress analysis of the proximo-medial femur after total hip replacement. *Journal of Biomedical Science*, 12(5), pp. 379-382.
- 4 Keaveny, T., & Bartel, D. (1993). Effects of porous coating and collar support on early load transfer for a cementless hip prosthesis. *Journal of Biomechanics*, 26(10), pp. 1205-1216.
- 5 Palm, L., Jacobsson, S., & Ivarsson, I. (2002). Hydroxyapatite coating improves 8- to 10-year performance of the link RS cementless femoral stem. *The Journal of Arthroplasty*, 17(2), pp. 172-175.

Additional Literature



688 MobileLink
OP-Impl-Instr en



679 BiMobile
OP-Impl-Instr en



677 LINK T.O.P. II
OP-Impl-Instr en

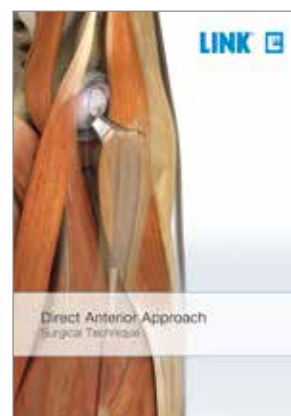

615 DAA_OP en



609 Acetabular Cups
cementable_OP-Impl-Instr en

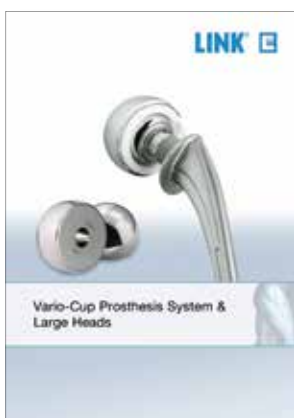

604_Vario-Gross
OP-Impl-Instr en

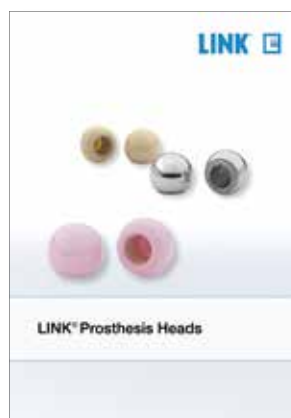

900_Prosthesis Heads
OP-Impl-Instr en



For more information please register for our LINK Media Library (linkorthopaedics.com)

<p>Indications and contraindications: C.F.P. Hip Prosthesis System</p>
<p>General Indications</p>
<p>Mobility-limiting diseases, fractures or defects of the hip joint or proximal femur which cannot be treated by conservative or osteosynthetic procedures</p>
<p>Indications</p>
<p>Primary and secondary osteoarthritis</p>
<p>Rheumatoid arthritis</p>
<p>Correction of functional deformities</p>
<p>Avascular necrosis</p>
<p>Contraindications</p>
<p>Poor general state of health</p>
<p>Acute and chronic infections, local and systemic</p>
<p>Allergies to (implant) materials</p>
<p>Distinctive muscular-, nerve-, vascular or other diseases, which put the affected limb at risk</p>
<p>Insufficient/inadequate bone mass- or quality which prevents a stable anchorage of the prosthesis</p>

Please note: These indications/contraindications refer to standard cases. The ultimate decision on whether or not an implant is suitable for a patient must be made by the surgeon based on his/her individual analysis and his/her experience.

The sizes small - x-large of the C.F.P. hip stem can be combined with prostheses heads up to +4mm additional neck length.

Please note the following regarding the use of our implants:

1. Choosing the right implant is very important.

The size and shape of the human bone determines the size and shape of the implant and also limits the load capacity. Implants are not designed to withstand unlimited physical stress. Demands should not exceed normal functional loads.

2. Correct handling of the implant is very important.

Under no circumstances should the shape of a finished implant be altered, as this shortens its life span. Our implants must not be combined with implants from other manufacturers. The instruments indicated in the Surgical Technique must be used to ensure safe implantation of the components.

3. Implants must not be reused.

Implants are supplied sterile and are intended for single use only. Used implants must not be used again.

4. After-treatment is also very important.

The patient must be informed of the limitations of the implant. The load capacity of an implant cannot compare with that of healthy bone!

5. Unless otherwise indicated, implants are supplied in sterile packaging.

Note the following conditions for storage of packaged implants:

- Avoid extreme or sudden changes in temperature.
- Sterile implants in their original, intact protective packaging may be stored in permanent buildings up until the "Use by" date indicated on the packaging.
- They must not be exposed to frost, dampness or direct sunlight, or mechanical damage.
- Implants may be stored in their original packaging for up to 5 years after the date of manufacture. The "Use by" date is indicated on the product label.
- Do not use an implant if the packaging is damaged.

6. Traceability is important.

Please use the documentation stickers provided to ensure traceability.

7. Further information on the material composition is available on request from the manufacturer.

Follow the instructions for use!

Waldemar Link GmbH & Co. KG, Hamburg

All content in this catalog, including text, pictures and data, is protected by law. Every instance of use, whether in part or in whole and which is not permitted by law, is subject to our prior consent. In particular, this applies to the reproduction, editing, translation, publishing, saving, processing, or passing on of content stored in databases or other electronic media and systems, in any manner or form. The information in the catalogs is solely intended to describe the products and does not constitute a guarantee.

The Surgical Technique described has been written to the best of our knowledge and belief, but it does not relieve the surgeon of his/her responsibility to duly consider the particularities of each individual case.

Products shown in this document may not be available in your country. The product availability is subject to the approval and/or registration regulations of the respective country. Please contact Waldemar Link GmbH & Co. KG if you have questions about the availability of LINK products in your country.

Waldemar Link GmbH & Co. KG and/or other corporate affiliated entities own, use or have applied for the following trademarks in many jurisdictions: LINK, BiMobile, SP II, Modell Lubinus, E-Dur, EndoDur, T.O.P. II, BetaCup, CombiCup PF, CombiCup SC, CombiCup R, MobileLink, C.F.P., LCU, SP-CL, LCP, MIT-H, Endo-Model, Endo-Model SL, MP, MEGASYSTEM-C, GEMINI SL, SPAR-K, LCK, HX, TiCaP, X-LINKed, PorAg, LINK PorEx, BiPorEx, PorEx-Z, TrabecuLink, Tilastan, customLINK, RescueSleeve, VACUCAST.

Other trademarks and trade names may be used in this document to refer to either the entities claiming the marks and/or names or their products and are the property of their respective owners.

