







LINK Embrace
Shoulder System

CE 0426

Explanation of Pictograms			
	Manufacturer		Article number
	Material (number)		Product meets the applicable requirements, which are regulated in the EU harmonization legislation for the affixing of the CE marking.

LINK Embrace Shoulder System

Chapter	Surgical Technique	02
1.	Pre-Op Planning	02
2.	Surgical Approaches and Patient Positioning	02
3.	Color Coding	03
4.	Hemi Shoulder Arthroplasty	05
5.	Total Shoulder Arthroplasty	51
6.	Reverse Total Shoulder Arthroplasty	105
7.	Conversion from Anatomic to Reverse Configuration	161
8.	Component Removal	164
9.	Implants	176
10.	Instruments	192
11.	Indications/Contraindications	204
12.	System Compatibility	206
	Notes	208
	Important Information	

1. Pre-Op Planning

The operation is planned with the assistance of standard X-rays with normal AP-view in internal and external rotation as well as an axillary view. For implantation of a glenoid component and in fracture cases a CT-Scan is recommended to better assess the glenoid configuration. Additionally, MRI may be indicated for assessment of the degree of bone deficiency as well as soft tissue and capsule quality. Neurological exams should be performed in post-traumatic and disabling shoulder cases.

LINK Embrace X-Ray templates are available for pre-op planning of osteoarthritic cases, they may also be used in fracture and revision cases as far as applicable. LINK Embrace X-ray templates have a 105% scale. Several digital planning platforms are supported.

2. Surgical Approaches and Patient Positioning

2.1 Surgical Approaches

The LINK Embrace Shoulder System is suitable for implantation using the existing surgical approaches. The instrument set supports the two most popular surgical approaches to the shoulder joint, delto-pectoral and lateral approach. Usually, the selected approach depends on the surgeon's experience and preferences, furthermore, the diagnosis and planned surgical treatment have to be taken into account. With the patient under anaesthesia, glenohumeral ROM is evaluated in order to assess the extent of capsular release needed to restore the ROM postoperatively.

2.2 Patient Positioning

It is recommended to perform shoulder arthroplasty in a beach-chair position. This allows for full access to the shoulder joint which is necessary to intraoperatively assess the joint function, stability and range of motion. To facilitate access to the joint and, if required, the use of fluoroscopy, the patient should be positioned as much lateral as possible to the affected side on the OR table. The head needs to be securely fixed.



Figure 2.1

3. Color Coding

The LINK Embrace Shoulder System offers diverse fixation and biomechanical options. The options offered by each implant are indicated by a color-coding matrix on each component package. Color-coding matrix 1 (figure 3.1) is applied on all implant components except Bone Screws, for which color-coding matrix 2 is used (figure 3.2).

Matrix 1 (figure 3.1) consists of seven cells in total. The first line contains product related information, such as component size, length or assignment. The left column indicates the possible biomechanical configurations the component can be used for. The right column indicates the fixation options to anchor the implant in the bone. The meaning of each cell is explained in table 3.1 below. Available options are highlighted by a specific colour, options not available are indicated by a grey cell (figure 3.1, right matrix).

L 100		Ø 13	
Anatomical	Cementless		
Reverse	Cemented		
CTA	Hybrid		

For Stemless Ring Cage	
CTA	

Figure 3.1 Example Color Coding Matrix 1

Color-coding matrix 2 (Figure 3.2) consists of four cells in total. The left column indicates the possible biomechanical configurations the component can be used for. The meaning of each cell is explained in table 3.1. Available options are highlighted by a specific colour, options not available are indicated by a grey cell (figure 3.2, right matrix).

The central cell contains the screw length L (in mm) in the first line and screw diameter (in mm) in the second line. The right cell indicates the screw type according to the three symbols explained in table 3.1.

Anatomical	L20	
Reverse	Ø 6.0	

	L20	
Reverse	Ø 6.0	

Figure 3.2 Example Color Coding Matrix 2

Anatomical	Indicates the component can be used for anatomical configurations (TSA). Please note this code also applies to Hemi Shoulder Arthroplasty (HEMI) when the glenoid is left native.
Reverse	Indicates the component can be used for reverse configurations (RSA).
CTA	Indicates the component is a CTA head or can be combined with a CTA head.
Cementless	Indicates cementless component fixation in the bone.
Cemented	Indicates cemented component fixation in the bone.
Hybrid	Indicates simultaneous cemented and cementless component fixation in the bone. Please refer to the surgical technique for further information.
	Indicates a central Bone Screw to be applied with the Convertible Metal-Back or Reverse Glenoid Baseplate.
	Indicates a peripheral angle-stable Bone Screw to be applied with the Reverse Glenoid Baseplate.
	Indicates a peripheral non angle-stable Bone Screw to be applied with the Reverse Glenoid Baseplate.

Table 3.1

4. Hemi Shoulder Arthroplasty

This chapter describes the surgical technique for Hemi Shoulder Arthroplasty in Anatomic (Anatomic Elective), Fracture and CTA Head configuration using

- Stemless Cages
- Stemless Ring Cages
- Humeral Short Stems
- Humeral Standard Stems
- Modular Stems with Proximal Bodies
- Modular Revision Stems with Proximal Bodies
- Humeral Fracture Stems
- Humeral Heads
- CTA Heads.

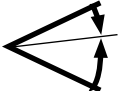
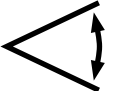
4.1 Humeral Head Resection

4.1.1 Intramedullary Alignment

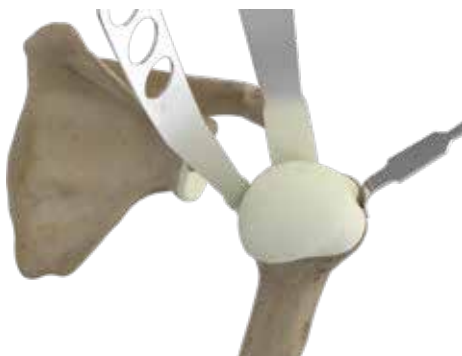

Figure 4.1

Expose and mobilize the humeral head and luxate it from the glenoid.



Figure 4.2

Open the medullary canal with a suitable instrument in line with the humeral axis.

NOTE: In case the implantation of a Stemless Cage/ Stemless Ring Cage is intended, it is recommended to perform the head resection using the extra-medullary alignment method (refer to 4.1.2).

Using the T-Handle, insert the Starter Awl into the medullary canal until the depth stop is reached. Make sure that the blue Depth Stop Disk rests in the Starter Awl shaft recess.



Figure 4.3

Prepare the Resection Guide depending on the surgical approach, i.e. selection of the Resection Block for delto-pectoral or for lateral approach.

NOTE: The LINK Embrace Instrument Set supports different surgical approaches. In the surgical technique described here, the delto-pectoral approach is used.

For lateral techniques use the Resection Block for lateral approaches and follow the workflow correspondingly.



Figure 4.4

Slide the Resection Guide down on the Starter Awl placed in the medullary canal by applying light pressure on the instrument spring clamp.



Figure 4.5

Connect the desired Resection Block and the Resection Guide Connector with the laser marks on both Connector Bar and Resection Block in line. The Resection Block is fixed to the Connector Bar by means of a magnetic connection.



Figure 4.6

Considering the side to be treated, insert the Resection Guide Connector into the fork of the Resection Guide. A slight initial resistance prevents the instrument from slipping out of the fork.



Figure 4.7

According to the desired retroversion, screw the Alignment Rod into the corresponding hole (0°, 10°, 20°, 30°) in the Alignment Rod Connector. Make sure to select the correct set of holes for treatment of the left or right side respectively, corresponding to the laser marking on the Alignment Rod Connector.

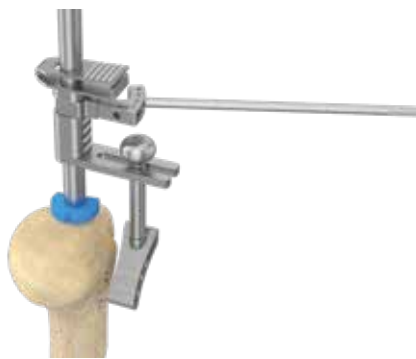

Figure 4.8

Place the Alignment Rod Connector with the Alignment Rod in the required orientation on the Resection Guide receptacle.



Figure 4.9

Set the desired retroversion by axially rotating the Resection Guide on the Starter Awl, adjusting the Alignment Rod parallel to the forearm which is held flexed at appr. 90°.

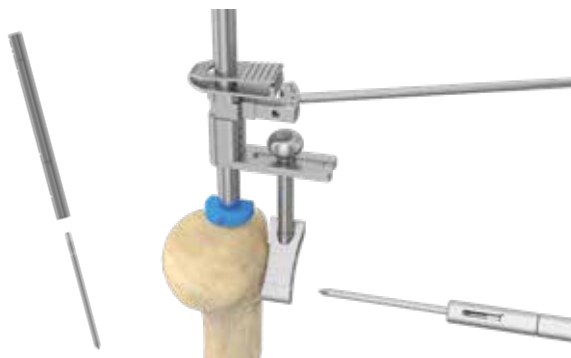

Figure 4.10

Adjust the Resection Guide to the desired resection level (to change the instrument level, press the instrument spring). The spring locks the instrument when released.

Finally determine the resection level with respect to the anatomical neck of the humeral head.

Push the Resection Block together with the Resection Guide Connector so that it slides within the fork until it gets into contact with the bone.

Fix the Resection Block with at least two Fixation Pins (3.0 mm) using the Universal Pin Inserter.

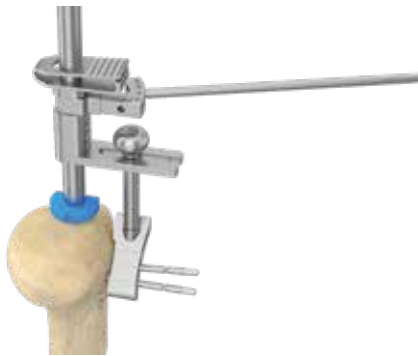

Figure 4.11

Outer pins run parallel and allow for sliding the Block on the pins. The central hole is oblique and locks the Resection Block position on the bone.

The orientation of the pinholes is marked accordingly on the Block. Take note that the most lateral pin might interfere with the intramedullary Starter Awl.

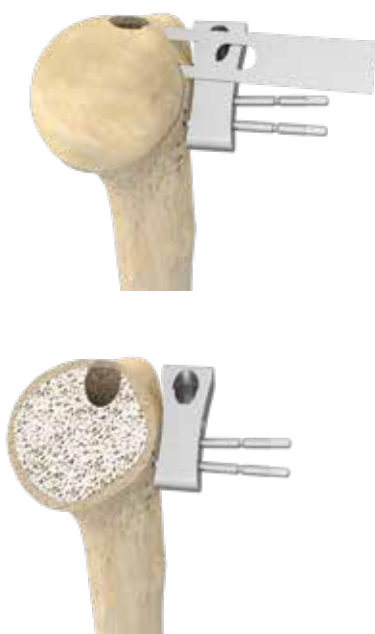

Figure 4.12

After final check of resection level and retroversion, the humeral head is resected with an oscillating saw blade on top of the Resection Block at 135° (defined by the instrument).

For this purpose, all instruments except the fixed Resection Block can be removed by pulling them upwards. To do so, press the spring on the Resection Guide, release the magnet connection between Resection Block and Resection Guide Connector and slide the Resection Guide upwards over the Starter Awl. Then remove the Starter Awl using the T-Handle.



Figure 4.13

For more stability, e.g. in case of poor fixation, the Resection Guide can also be left in place. When sawing, make sure to avoid any instrument interference.

The required Humeral Head diameter is now estimated using the Humeral Trial Heads, aiming at optimal coverage of the resection surface with the Trial Head.



Figure 4.14

Alternatively, the required head diameter and height can also be determined with the Sizing Gauge for Humeral Heads.

When using the Sizing Gauge, take into account any possible deformities of the natural head.

When selecting the suitable Humeral Head diameter in TSA, it is important to note that only certain Humeral Head and Glenoid Component sizes may be combined as shown in chapter 5.3.1., table 5.1.



Figure 4.15

Remove all instruments. Pins can be removed with the Pin Inserter/Extractor.

4.1.2 Extramedullary Alignment



Figure 4.16

Alternatively to intramedullary alignment and especially when Stemless Cages or Stemless Ring Cages are planned to be implanted, use the Resection Guide for extramedullary alignment. The extramedullary Resection Guide has a built-in angle of 135°.



Figure 4.17

According to the desired retroversion, screw the threaded end of the Alignment Rod into the corresponding hole (0°, 10°, 20°, 30°) on the vertical Resection Guide bar. The Guide has two opposing sets of holes for left and right application.



Figure 4.18

Align the rod-shaped neck of the instrument along the humeral shaft axis. A second Alignment Rod may be screwed into the hole at the distal Guide end, prolonging the instrument axis for easier positioning.



Figure 4.19

Set the desired retroversion by internal or external rotation of the Guide, adjusting the Alignment Rod parallel to the forearm which is held flexed at approx. 90°.



Figure 4.20

Determine the final resection level with respect to the anatomical neck of the humeral head. Fix the Resection Guide with at least two Fixation Pins (3.0 mm) using the Universal Pin Inserter. Outer pins run parallel and allow for sliding the Block on the pins. The central hole is oblique and locks the Resection Block position on the bone. The orientation of the pinholes is marked accordingly on the Guide.

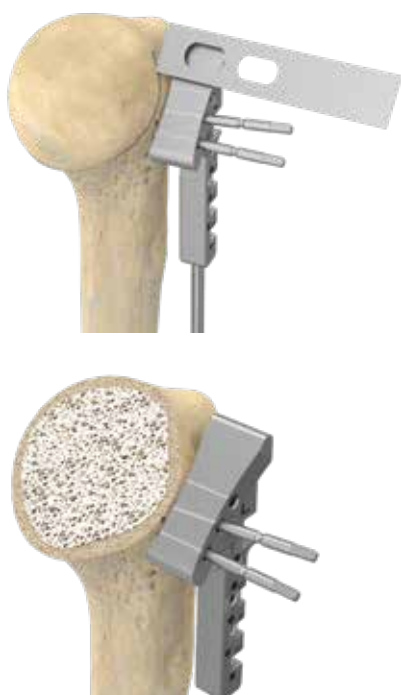

Figure 4.21

After final check of level and retroversion, resect the humeral head with an oscillating saw blade on top of the Resection Guide.

4.1.2.1 Alternative Retroversion Determination

The LINK Embrace Instrument Set supports an alternative way to determine the retroversion, using the Alignment Rod and the Alignment Rod Connector.



Figure 4.22

According to the desired retroversion, place the Alignment Rod into the corresponding hole (0°, 10°, 20°, 30°) in the Alignment Rod Connector. Make sure to select the correct set of holes for treatment of the left or right side respectively.

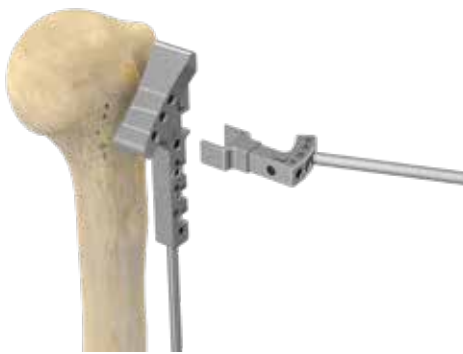

Figure 4.23

Place the Alignment Rod Connector with the Alignment Rod in the required orientation on the Resection Guide receptacle.

Go on as described in 4.1.2

4.2 Humerus Preparation

4.2.1 Stemless Cage/Stemless Ring Cage Preparation

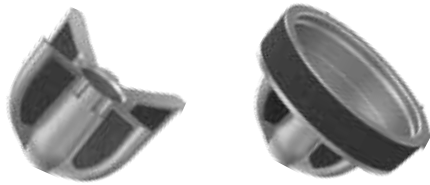

Figure 4.24

NOTE: The LINK Embrace System offers two types of Stemless Components: Stemless Cages (left) and Stemless Ring Cages (right).

Stemless Cages are used only for primary anatomical reconstruction with good bone quality in combination with LINK Embrace Head Adapters and Humeral Heads. In the case of later revision, they can be converted to a reverse configuration provided good bone integration has been achieved. Stemless Ring Cages can be used for primary anatomical and primary reverse treatment. These Cages are designed to either directly host the Reverse Inserts or to be combined with specific adapters for Humeral Heads and CTA Heads, allowing for anatomic reconstruction. All LINK Embrace Stemless Cages have a TrabecuLink surface, aiming at fast and stable component integration into the surrounding bone.



Figure 4.25

Resect the humeral head using the Extramedullary Resection Guide, taking into account the desired retroversion and the desired resection level as described in 4.1.2.



Figure 4.26

Determine the size of the Cage using the Sizer Disks. Place the Sizer Disk on the resection surface and check for best circumferential fit.

NOTE: Sizer Disks are available in sizes 30, 32, 34, 36, 38 and 40 mm.
Stemless Cages are available in sizes 30, 32, 34, 36, 38, 40.
Stemless Ring Cages are available in sizes 34, 36, 38, 40.
Sizer disks have exactly the same diameter as the corresponding implant.

NOTE: Stemless Cages/Stemless Ring Cages are designed to be implanted in cancellous bone.
It is recommended to select the biggest component possible in each individual case.
When positioning the Cage, make sure the Cage wings are not directly oriented towards the biceps tendon groove.

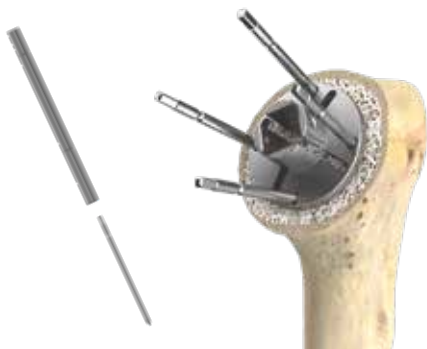

Figure 4.27

Position the appropriate Sizer Disk with optimal fit on the resection surface and slightly impact to fix it with the back pins in the bone.

Lock the Sizer Disk with at least two additional, opposite Fixation Pins through the pin holes at the Sizer Disk edge, using the Universal Pin Inserter.



Figure 4.28

Place the Sizer Sleeve for K-Wires on the Sizer Disk.



Figure 4.29

Push the K-Wire for Stemless Cage preparation (\varnothing 2.7 mm) through the Sizer Sleeve into the bone. Stop advancing the K-Wire upon cortical contact.

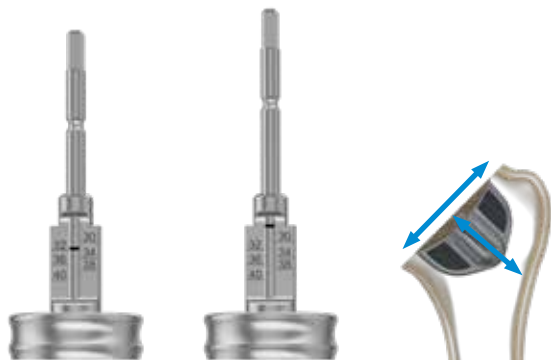

Figure 4.30

Check the laser mark on the K-Wire within the window of the Sizer Sleeve shaft. The mark indicates the biggest possible size of the Stemless Cage/ Stemless Ring Cage. In case the K-Wire laser mark is at the level or below the size 30 mark (on the window scale, figure/left), the humerus is big enough to host the Stemless Cage/Stemless Ring Cage of the size indicated. If the K-Wire mark is above the mark for size 30 (figure/middle), the humerus is too small to host a Stemless Cage. In this case, consider to use a stemmed component.



Figure 4.31

Remove the K-Wire with the Pin Inserter/Extractor. Replace the Sizer Sleeve for K-Wires with the Center Sleeve for the Central Peg Punch.



Figure 4.32

Drive the Central Peg Punch through the Sizer Disk and impact until the depth stop is reached.



Figure 4.33

Remove the Central Peg Punch and the Center Sleeve. Screw the Punch/Trial Cage for Stemless Cages of the same size as the Sizer Disk used onto the Impactor for Stemless Cages/Ring Cages. Make sure the Depth Stop Disk rests in the Impactor shaft recess.



Figure 4.34

Drive the Punch/Trial Cage for Stemless Cages through the Sizer Disk until the depth stop is reached.

4.2.1.1 Stemless Cage Preparation



Figure 4.35

Unscrew the Impactor from the Punch/Trial Cage, leaving the Punch in situ. Remove the Fixation Pins and the Sizer Disk using the Pin Inserter/Extractor.



Figure 4.36

Connect the Finishing Reamer to the T-Handle (Hudson fitting).



Figure 4.37

Ream the humeral resection surface with the Finishing Reamer connected to the T-Handle and create a concave surface. To do so, insert the blue Reamer guiding Sleeve into the female taper of the Punch/Trial Cage and align axially.

Ream manually until the depth stop is reached. Remove the Reamer.

Leave the Punch in situ. This serves as a Trial Cage and is used for trial reduction in the next step. Go on with chapter 4.3.1.

4.2.1.2. Stemless Ring Cage Preparation



Figure 4.38

Remove the Punch/Trial Cage using the Impactor for Stemless Cages/Stemless Ring Cages. Remove the Fixation Pins and the Sizer Disk using the Pin Inserter/Extractor.



Figure 4.39

Screw the Punch/Trial Cage for Stemless Ring Cage of the same size as the Sizer Disk used onto the Impactor for Stemless Cages/Stemless Ring Cages.



Figure 4.40

Align the Punch/Trial Cage with the prepared implant bed and impact until the upper surface of the Punch ring is flush with the resection plane.



Figure 4.41

Connect the Reamer for Stemless Ring Cage preparation to the T-Handle in order to remove the cancellous bone within the Punch ring. Alternatively, compact the bone with an appropriate instrument.



Figure 4.42

Ream and remove the bone until the depth stop is reached.

Leave the Punch in situ. This serves as a Trial Cage and is used for trial reduction in the next step. At this stage, you may use the bone removed with the Reamer and press it into the cancellous bone cavities for interdigitation.

Go on with chapter 4.3.2.

4.2.2 Humeral Standard and Short Stem Preparation

NOTE: The LINK Embrace System offers Humeral Stems in two different lengths: Humeral Standard Stems with 100 mm and Humeral Short Stems with 75 mm length. For both ranges dedicated humeral Compressors are used. Compressors are 5 mm longer than the corresponding Stems.



Figure 4.43

Medullary canal preparation is started with the smallest Compressor (size 12) in the required length (75 mm or 100 mm).

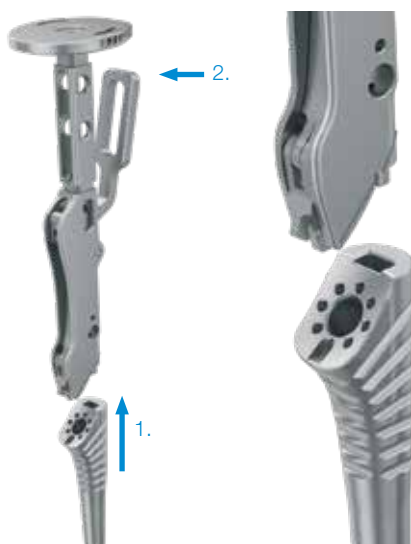

Figure 4.44

Connect the Compressor to the Handle for Compressors and Proximal Bodies by opening the Handle lever and inserting the nose piece at the end of the Handle into the Compressor's groove located laterally. Close the Handle lever, locking the Compressor firmly to the Handle.

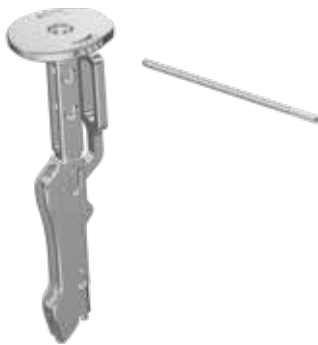

Figure 4.45

According to the desired retroversion, screw the threaded end of the Alignment Rod into the corresponding hole (0°, 10°, 20°, 30°) in the rim of the Handle impaction plate. Make sure to select the correct set of holes for treatment of the left or right side respectively.



Figure 4.46

Alternatively, the Alignment Rod may be used together with the Alignment Rod Connector to determine the desired retroversion as described in 4.1.1.

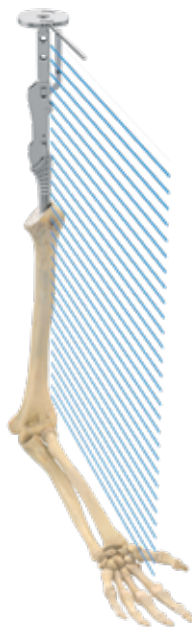

Figure 4.47

Insert the Handle with the Compressor into the humeral shaft. Set the desired retroversion by axially rotating the Handle, adjusting the Alignment Rod parallel to the forearm which is held flexed at approx. 90°.



Figure 4.48

Gradually prepare the humeral canal until the size determined in the preoperative planning is reached. The Compressor has to be stable and the line mark on the Handle has to be flush with the resection surface (red circle). The Compressor is now slightly recessed within the bone.



Figure 4.49



Figure 4.50



Figure 4.51



Figure 4.52

Remove the Handle, leaving the last Compressor in situ.

Connect the Finishing Reamer with the T-Handle (Hudson fitting).

Ream the humeral resection surface with the Finishing Reamer and create a concave front face. To do so, insert the blue Reamer guide tip into the female taper of the humeral Compressor and align axially.

Ream manually until the depth stop is reached. Remove the Reamer.

Depending on the posterior head offset, choose the appropriate Humerus Protection Plate from two options: neutral or 6 mm offset version.

Place the selected Humerus Protection Plate on the resection surface with its peg in the central hole of the humeral component.

Depending on the preferred workflow, glenoid preparation can be performed immediately after humeral head resection. The Humerus Protection Plates can also be placed directly onto the bone and be fixed with the aid of the backside pins.

Go on with chapter 4.3.3.

4.2.3 Proximal Body, Modular Stem/Modular Revision Stem and Humeral Fracture Stem Preparation (FX)



Figure 4.53

After removing the bone fragments, the required head diameter and height are determined using the head fragment and the Sizing Gauge for Humeral Heads.

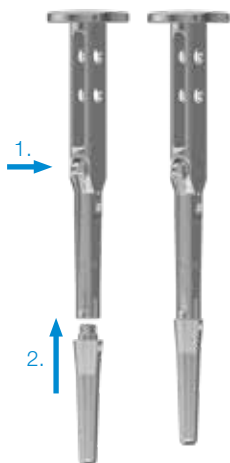

Figure 4.54

Determine the appropriate diameter and length of the Modular Stem/Modular Revision Stem using the Modular Trial Stems, which are coupled to the Handle for Modular Trial Stems. To attach the Modular Trial Stem to the Handle, press the Handle lever.

Place the Trial Stem on the Handle and release the lever. For disassembly, press the lever again and remove the Trial Stem.



Figure 4.55

The selected Modular Trial Stem is carefully driven into the bone until good stability is achieved.

NOTE: To adjust the prosthesis height, the LINK Embrace Shoulder System offers Proximal Bodies and Trials in three different heights: -5, 0 and +5, each in three sizes: S, M and L. A Template for Proximal Bodies is used to determine the required Proximal Body height.

NOTE: The Template is used for both left and right side. To adapt the Template to the appropriate side, slide the Template plate on the Template bar into the circumferential recess. Rotate the Template plate by 90° and detach it from the Template bar. Depending on the side to be treated, flip the plate so that the front marking reads “left” or “right”. Reattach the plate to the bar by sliding it over the flattened bar end into the recess. Rotate the plate by 90° and slide it on the Template bar.

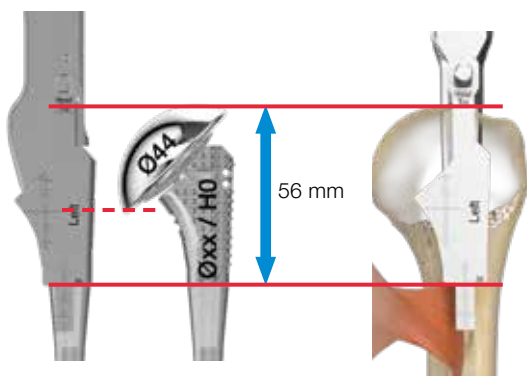

Figure 4.56

NOTE: To determine the required height of the Proximal Body, the Template for Proximal Bodies references to the proximal insertion of the Pectoralis Major m., which is approximately 56 mm below the highest point of the humeral head.

The Template contour corresponds to the Proximal Body of height “0” and size “S”.

The upper line mark on the Template indicates the height of a Humeral Head with a diameter of 44 mm and a height of 16 mm. The lower end of the scale is 56 mm below the upper line mark. The position of the scale end relative to the insertion can be used to determine if a different Modular Stem (length and size) and/or a higher Proximal Body has to be used.



Figure 4.57

Check the correct height level of the Stem considering the required height of the Proximal Body.

To do so, attach the Template for Proximal Bodies to the Handle for Modular Trial Stems by inserting the Template bar and pin into the corresponding grooves located on the Handle.

A magnetic connection fixes the Template bar to the Handle.



Figure 4.58

Connect the Handle to the Trial Stem in situ and refer to the insertion of Pectoralis Major m. as described. In case the required level can not be achieved with the different Proximal Body heights available, adapt the level of the Modular Trial Stem. To do so, it may be necessary to select a Modular Trial Stem of a different size and/or length.



Figure 4.59

Once an appropriate Trial Stem has been inserted, remove the Handle for Modular Trial Stems.

Connect the Proximal Trial Body with height “0” and size “M” to the Handle for Compressors and Proximal Bodies.

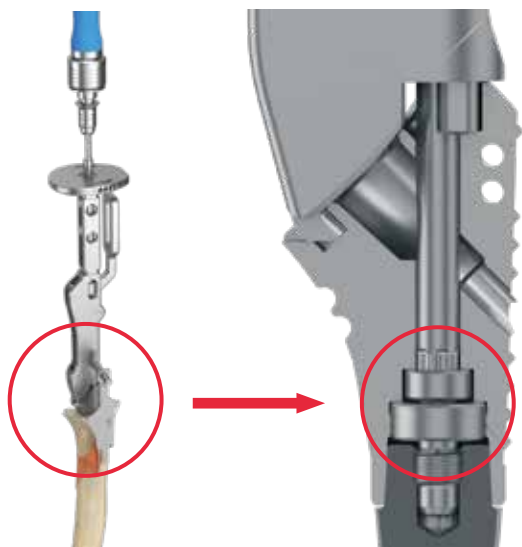

Figure 4.60

Place the Proximal Trial Body on the Modular Trial Stem located in situ.
Connect the Torx 25 Screwdriverbit to the Ratchet and push it through the cannulated Handle into the Proximal Trial Body. Make sure the Screwdriverbit fully engages into the head of the preassembled locking screw within the trial component.



Figure 4.61

Tighten the locking screw slightly with the Ratchet to create the connection between Modular Trial Stem and Proximal Trial Body.
According to the desired retroversion, screw the threaded end of the Alignment Rod into the corresponding hole (0°, 10°, 20°, 30°) in the rim of the Handle impactation plate. Make sure to select the correct set of holes for treatment of the left or right side respectively.

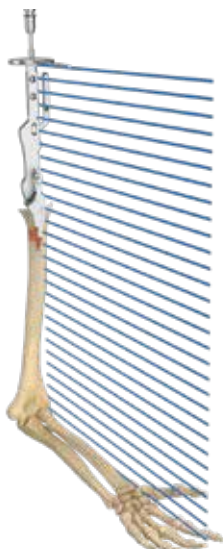

Figure 4.62

Alternatively, use the Alignment Rod together with the Alignment Rod Connector to determine the desired retroversion as described in 4.1.1.
Set the desired retroversion by axially rotating the Handle, adjusting the Alignment Rod parallel to the forearm which is held flexed at approx. 90°. To do so, slightly loosen the locking screw within the Proximal Trial Body.

Once the desired retroversion has been adjusted, tighten the screw and remove both Screwdriver and Handle.

Go on with chapter 4.3.4.

4.3 Humeral Components: Trialing

4.3.1 Stemless Cage Trialing



Figure 4.63

Select the suitable Humeral Trial Head (diameter and height).

NOTE: The LINK Embrace System includes Humeral Heads and trial components in various diameters and heights. Furthermore, different Head Adapters and trial components with different offsets (eccentricities) are available for reconstruction of the individual anatomy. It is recommended to start with a neutral Head Trial Adapter and a medium height Trial Head.



Figure 4.64

Firmly push the neutral Head Trial Adapter into the Punch. A spring-loaded clamp connection fixes the Head Trial Adapter to the Punch.



Figure 4.65

Place the Trial Head on the Head Trial Adapter. These are fixed to each other by a magnetic connection. Assess the coverage of the resection plane.

NOTE: The Punch/Trial Cage for Stemless Cages can only accept neutral (concentric) Head Trial Adapters. In case a Head Adapter with offset is required, implant the final Stemless Cage first. Then determine the Head Adapter's eccentricity and orientation in the way described in the subsequent note.



Figure 4.66

NOTE: If required, coverage can be optimized by selecting a Head Trial Adapter with offset (available in 2, 4 and 6 mm offset). Head Trial Adapters (alike the final Head Adapters with offset, refer to figure) have a rear pin that is inserted into one of the holes in the humeral component front face and allows adjustment in 45° steps.



Figure 4.67

Head Trial Adapters and final Head Adapters have a dial-like ring, used to precisely determine and reproduce the selected position. For this purpose, the most laterally located digit on the Head Trial Adapter is noted and the final Head Adapter is later on positioned accordingly with the same digit most laterally (e.g. in the figure the most laterally digit is “1” in a 4 mm offset Head Trial Adapter/Head Adapter). For easier identification of the Head Trial Adapter position, Trial Heads have the same dial-like ring at the rim.

Check the required Head height referring to the anatomical landmarks and, if necessary, correct with more suitable Head heights.

Perform a trial reduction to check stability, tension and function of the joint. If necessary, adjust the configuration using a more suitable Head Trial Adapter (only in combination with final Stemless Cage implanted) and/or Trial Head.

Remove the trial components manually, leaving the Punch/Trial Cage in situ.

Go on with chapter 4.4.1.

4.3.2 Stemless Ring Cage Trialing

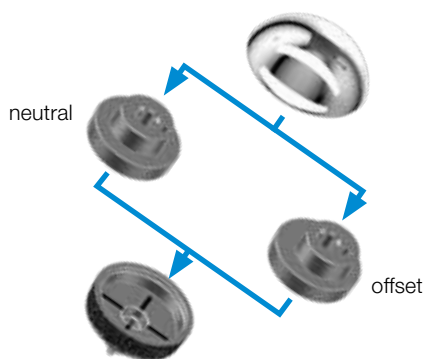

Figure 4.68

NOTE: Stemless Ring Cages can be used for anatomic reconstruction with Humeral Heads by means of Stemless Ring Cage Head Adapters. These are provided in neutral and 2 mm offset version.

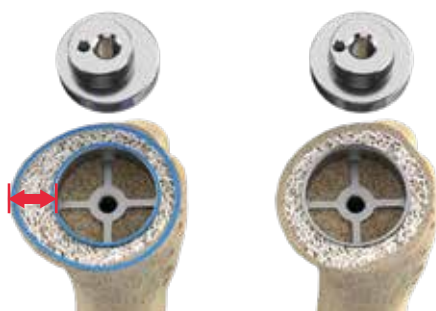

Figure 4.69

Assess the degree and orientation of deviation from the central position. In case the Punch/Trial Cage is well centered, select the neutral Adapter. Otherwise, select the offset Adapter and define the direction of the eccentricity, aiming at optimal Head coverage. Mark the eccentricity (arrow) on the bone, e.g. using electro cautery.



Figure 4.70

Place the Trial Head directly on the resection surface.
Assess the coverage of the resection plane and the head height and select the required Humeral Head accordingly (diameter and height).

Go on with chapter 4.4.2.

4.3.3 Humeral Standard & Short Stem Trialing



Figure 4.71

Remove the Humerus Protection Plate.
Select the suitable Humeral Trial Head (diameter and height).

NOTE: The LINK Embrace System includes Humeral Heads and trial components in various diameters and heights. Furthermore, different Head Adapters and trial components with different offsets (eccentricities) are available for reconstruction of the individual anatomy. It is recommended to start with a neutral Head Trial Adapter and a medium height Trial Head.



Figure 4.72

Firmly push the neutral Head Trial Adapter (0 mm offset) into the Compressor. A springloaded clamp connection fixes the Adapter to the Compressor.



Figure 4.73

Place the Trial Head onto the Head Trial Adapter. These are fixed to each other by a magnetic connection.
Assess the coverage of the resection plane.



Figure 4.74

NOTE: If required, coverage can be optimized by selecting a Head Trial Adapter with offset (available in 2, 4 and 6 mm offset). Head Trial Adapters (like the final Head Adapters with offset, refer to figure) have a rear pin that is inserted into one of the holes in the humeral component front face and allows adjustment in 45° steps.



Figure 4.75

Head Trial Adapters and final Head Adapters have a dial-like ring, used to precisely determine and reproduce the selected position. For this purpose, the most laterally located digit on the Head Trial Adapter is noted and the final Head Adapter is later on positioned accordingly with the same digit most laterally (e.g. in the figure the most laterally digit is “3” in an 4 mm offset Head Trial Adapter/Head Adapter). For easier identification of the Head Trial Adapter position, Trial Heads have the same dial-like ring at the rim.

Check the required Head height referring to the anatomical landmarks and, if necessary, correct with more suitable Head heights.

With the Trial Head in place, perform a trial reduction to check the stability, tension and function of the joint.

If necessary, adjust the configuration using a more suitable Head Trial Adapter and/or Trial Head.

In case a Head Trial Adapter with offset is used, the laterally located digit on the Adapter is to be noted as described above in order to identically reproduce the position with the final component later on.

Remove the trial components manually.

Remove the Compressor using the Handle.

Go on with chapter 4.4.3.

4.3.4 Proximal Body, Modular Stem/Modular Revision Stem and Humeral Fracture Stem Trialing (FX)



Figure 4.76

NOTE: It is generally recommended to start the trial reduction with a neutral Head Trial Adapter combined with Humeral Trial Head determined with the Sizing Gauge for Humeral Heads.

NOTE: Neutral Head Adapters (offset 0 mm) are provided with (figure) and without circular holes to allow for tuberosities reattachment depending on surgeon's preference.



Figure 4.77

Firmly press the neutral Head Trial Adapter (0 mm offset) into the Proximal Body or the Humeral Fracture Stem (monoblock) respectively.



Figure 4.78

Place the required Humeral Trial Head on the Head Trial Adapter.

4.3.4.1 Proximal Body, Modular Stem/Modular Revision Stem Trialing (FX)



Figure 4.79

Perform a trial reduction and, if necessary, adjust the selected trial components and the alignment.

Both the Head Trial Adapter and the Trial Head have a cut out. Align both cut outs in lateral position to change the retroversion using the Screwdriver without removing the trial components. To do this, push the long Screwdriverbit, Torx 25, connected to the Ratchet, through the cut outs into the preassembled locking screw within the Proximal Trial Body and untighten it slightly. The retroversion can now be adjusted. Finally, retighten the locking screw and remove the Screwdriver. Repeat the trialing.



Figure 4.80

If no further adjustments are required, the selected retroversion can be marked on the bone, e.g. with electric cauter, according to the line markings on the Proximal Trial Body.

The implantation level can now also be transferred from the Template to the bone for orientation when implanting the final component.

Go on with chapter 4.4.4.1 (cementless implantation) or chapter 4.4.4.2 (cemented implantation).

4.3.4.2 Humeral Fracture Stem Trialing (FX)

NOTE: The LINK Embrace System offers monoblock Humeral Fracture Stems in sizes 12, 13, ..., 24 for simple and fast treatment of humeral fractures. The proximal shape of these monoblock Stems corresponds to a Proximal Body of height 0 (Proximal Bodies are available in three heights -5, 0 and +5, refer to 4.2.3), whereby the proximal diameter grows harmoniously with increasing size. Distally, monoblock Fracture Stems correspond to a Modular Stem of the same size with 75 mm length.

Trial components for sizes 12 and 13 come as a monoblock. For all other sizes, the humeral trial component is assembled using the corresponding size of the 75 mm Modular Trial Stem and the Proximal Trial Body with height 0 and size M. In consequence, assembled trial components and final components have slightly different volume in the proximal section. This must be taken into account for the subsequent reattachment of the tuberosities.

Prepare the humerus and determine the required diameter of the Modular Stem as described in 4.2.3.

For sizes 12 and 13, perform trial reduction with the Humeral Fracture Trial Stems (monoblock) provided.

For sizes 14 - 24, combine Modular Trial Stems L 75 mm of the required diameter with the Proximal Trial Body with height 0 and size M. Assemble the components as described in 4.2.3.

Determine the required height of the component. To do so, connect the Template for Proximal Bodies to the Handle for Compressors and Proximal Bodies and attach the Humeral Fracture Trial Stem to the Handle.

Go on as described in 4.2.3.

Assemble Head Trial Adapter and Humeral Trial Head as described in 4.3.4.

Perform the trial reduction as described in 4.3.4.1 correspondingly.

Go on with chapter 4.4.4.1 (cementless implantation) or chapter 4.4.4.2 (cemented implantation).

4.4 Humeral Components: Implantation

4.4.1 Stemless Cage Implantation

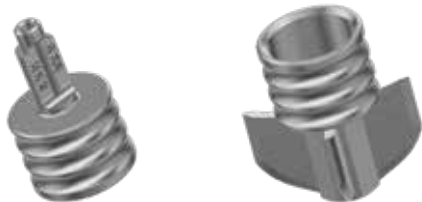

Figure 4.81

NOTE: Alternatively to assembling the component in situ as described here, the component can be completely assembled on the sterile table and impacted as a whole afterwards. In this case, follow the workflow described here correspondingly.

Introduce the Sizing Sleeve with the tubed end into the Punch/Trial Cage located in situ.

Using a power tool, introduce the K-Wire for Stemless Preparation through the Sleeve into the bone and lock it in the cortical wall. Remove the Sizing Sleeve.

Remove the Punch/Trial Cage using the Impactor for Stemless Cages/Ring Cages. The K-Wire remains in situ and serves as a guide for the implantation of the Stemless Cage.

Slide the Impactor for Stemless Cages/Ring Cages through the Impactor Sleeve.



Figure 4.82

Select the Stemless Cage of the same size as the last Punch/Trial Cage used and remove the transportation lock (white plastic cover). Screw the Cage on the assembled Impactor for Stemless Cages/Ring Cages.



Figure 4.83

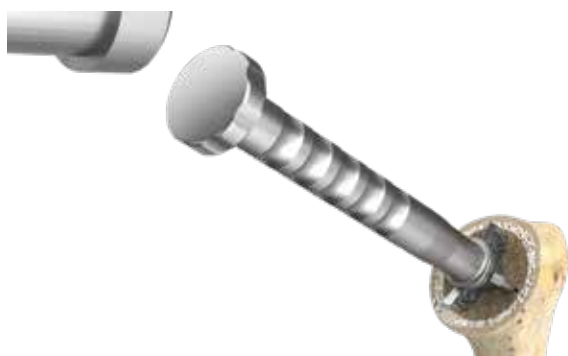

Figure 4.84

Axially insert the Cage over the K-Wire into the situs and align the Cage wings according to the prepared implant bed.

At first, the Stemless Cage should not be completely impacted but protrude slightly from the humerus. This facilitates the complete coupling of the taper connection between Head Adapter and Humeral Head. Remove the K-Wire with the Pin Inserter/Extractor.



Figure 4.85

Place the required Head Adapter, reproducing the configuration selected in the trial reduction. For Head Adapters with offset, the final alignment can be determined at this stage. To do so, use the Head Trial Adapter with offset and Humeral Trial Head and perform a trial reduction. Adapt if necessary. In Trial Head Adapters with offset, note the most lateral digit on the Head Trial Adapter.

NOTE: when performing a trial reduction at this stage, consider the Stemless Cage is not yet completely seated which might influence the soft tissue tension.



Figure 4.86

Remove Trial Head and Head Trial Adapter. Place the required final Head Adapter, reproducing the configuration selected in the trial reduction. To do so, align the same digit as the digit determined with the trial prosthesis laterally.



Figure 4.87

Insert the Fixation Screw into the Head Adapter (supplied with the Head Adapter).

Connect the Torx 25 Screwdriverbit to the 3 Nm Torque Wrench and slide it through the Counter Sleeve with the small Sleeve pin at the lower end.



Figure 4.88

Introduce the prepared Screwdriver into the Adapter Fixation Screw and position the Sleeve pin in the small hole in the Head Adapter.



Figure 4.89

Tighten the Screw by turning the Screwdriver clockwise while holding the Sleeve firmly in place with your other hand. The required torque of 3 Nm is reached when a clicking noise can be heard.



Figure 4.90

Place the Humeral Head with the required diameter and height on the Head Adapter. Impact the Humeral Head with the concave Impactor for Humeral Heads. The entire prosthesis is carefully impacted into the humerus until the underside of the Head Adapter rests on the bone surface. Check the Head fixation manually.



Figure 4.91



Figure 4.92

Perform reduction and final check.

If adjustments are necessary, both Humeral Head and Head Adapter can be removed.

For further information on component removal refer to chapter 8.

4.4.2 Stemless Ring Cage Implantation

NOTE: Alternatively to assembling the component in situ as described here, the component can be completely assembled on the sterile table and impacted as a whole afterwards.

In this case, follow the workflow described here correspondingly.

Introduce the Sizing Sleeve with the tubed end into the Punch/Trial Cage for Stemless Ring Cage located in situ.

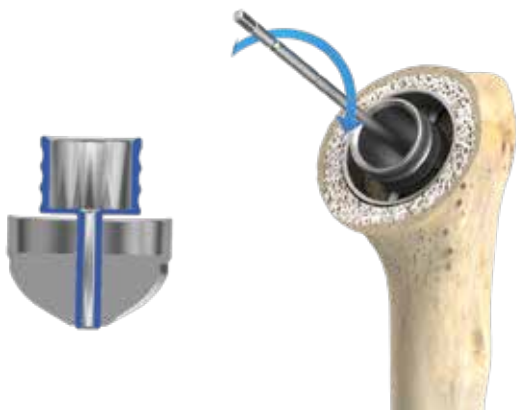

Figure 4.93

Using a power tool, introduce the K-Wire for Stemless Preparation through the Sleeve into the bone and lock it in the cortical wall. Remove the Sizing Sleeve.

Remove the Punch/Trial Cage for Stemless Cage using the Impactor for Stemless Cages/Ring Cages. The K-Wire remains in situ and serves as a guide for the implantation of the Stemless Ring Cage.



Figure 4.94

Select the Stemless Ring Cage of the same size as the last Punch/Trial Cage for Stemless Ring Cage used and screw it on the Impactor for Stemless Cages/Ring Cages.



Figure 4.95

Axially insert the Cage over the K-Wire into the situs and align the Cage wings according to the prepared implant bed. A laser mark inside the Stemless Ring Cage indicates the position of the 4 backside wings.

At first, the Stemless Ring Cage should not be completely impacted but protrude slightly from the humerus. This facilitates the complete coupling of the taper connection between Stemless Ring Cage Head Adapter and Humeral Head. Remove the K-Wire with the Pin Inserter/Extractor.



Figure 4.96

Fit the Stemless Ring Cage Head Adapter into the Cage. In case an Adapter with offset is used, reproduce its position determined and marked in the trial reduction.



Figure 4.97

Place the Humeral Head with the required diameter and height on the Adapter as determined in the trial reduction.

Impact the Humeral Head with the concave Impactor for Humeral Heads. The entire prosthesis is carefully impacted into the humerus until the underside of the Humeral Head rests on the bone surface. Check the Head fixation manually.



Figure 4.98

Perform reduction and final check.

If adjustments are necessary, the Humeral Head and Stemless Ring Cage Head Adapter can be removed. For further information on component removal, refer to chapter 8.

4.4.3 Humeral Standard and Short Stem Implantation

4.4.3.1 Cementless Humeral Standard and Short Stem Implantation

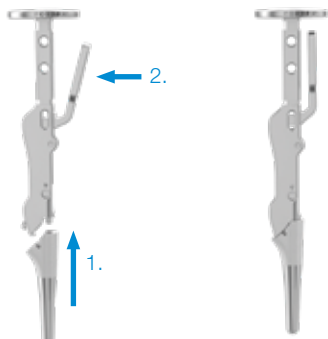

Figure 4.99

NOTE: For cementless implantation, the Humeral Standard or Short Stem of the same size as the last Compressor is used. Compressors and Stems with the same size designation have identical dimensions (Compressors have + 5 mm length).

Remove the transportation lock (white plastic cover) from the selected Humeral Stem.
Connect the Humeral Stem to the Handle.



Figure 4.100

Impact the Humeral Stem taking into account the desired retroversion. For this purpose, the Alignment Rod is screwed into the appropriate hole in the Handle impactation plate rim. Make sure to select the correct set of holes for left and right side treatment.



Figure 4.101

Alternatively, place the Alignment Rod Connector on the Handle and insert the Alignment Rod in the appropriate hole. Make sure to select the correct position of the Alignment Rod Connector for left and right side treatment.

At first, the Humeral Stem should not be completely impacted but protrude slightly from the humerus. This facilitates the complete coupling of the taper connection between Head Adapter and Humeral Head.



Figure 4.102

Place the required Head Adapter, reproducing the configuration selected in the trial reduction. For Head Adapters with offset, the same digit as the digit determined with the trial prosthesis must be aligned laterally.



Figure 4.103

Insert the Fixation Screw into the Head Adapter (supplied with the Head Adapter).



Figure 4.104

Connect the Torx 25 Screwdriverbit to the 3 Nm Torque Wrench and slide it through the Counter Sleeve with the small Sleeve pin at the lower end.



Figure 4.105

Introduce the prepared Screwdriver into the Adapter Fixation Screw and position the Sleeve pin in the small hole in the Head Adapter.



Figure 4.106

Tighten the Screw by turning the Screwdriver clockwise while holding the Sleeve firmly in place with your other hand. The required torque of 3 Nm is reached when a clicking noise can be heard.



Figure 4.107

Place the Humeral Head with the required diameter and height on the Head Adapter. Impact the Humeral Head with the concave Impactor for Humeral Heads. The entire prosthesis is carefully impacted into the humerus until the underside of the Head Adapter rests on the bone surface. Check the Head fixation manually.



Figure 4.108

Perform reduction and final check. If adjustments are necessary, both Humeral Head and Head Adapter can be removed. For further information on component removal, refer to chapter 8

4.4.3.2 Cemented Humeral Standard Stem Implantation

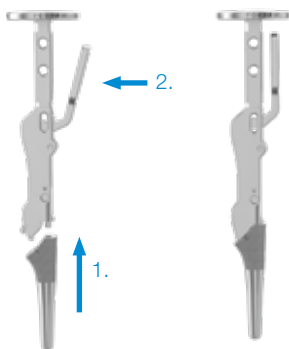

Figure 4.109

NOTE: For cemented implantation, select the Humeral Standard Stem one or two sizes smaller than the last Compressor used. When selecting the Humeral Stem one size smaller than the last Compressor, a cement mantle thickness of approx. 0.5 mm is achieved.

NOTE: Alternatively to assembling the component in situ as described here, it is recommended to completely assemble the humeral component on the sterile table and insert it as a whole afterwards in axial alignment. In this case, follow the workflow described here correspondingly.

The use of high viscosity cement is recommended for cementation.

Remove the transportation lock (white plastic cover) from the selected Humeral Stem. Connect the Humeral Stem to the Handle.



Figure 4.110

Clean the bone using jet or pulse lavage and apply the cement.

Insert the Humeral Stem into the soft cement taking into account the desired retroversion. For this purpose, the Alignment Rod is screwed into the appropriate hole in the Handle impactation plate rim. Make sure to select the correct set of holes for left and right side treatment.



Figure 4.111

Alternatively, place the Alignment Rod Connector on the Handle and insert the Alignment Rod in the appropriate hole. Make sure to select the correct position of the Alignment Rod Connector for left and right side treatment.



Figure 4.112

Manually press down the Stem into the soft cement until it is positioned at the same level as the last Compressor used. Remove excessive bone cement. With the Handle, the prosthesis is held in position until the cement is cured.

Align and fix both Head Adapter and Humeral Head as described in 4.4.3.1.

4.4.4 Proximal Body, Modular Stem/Modular Revision Stem and Humeral Fracture Stem Implantation (FX)

4.4.4.1 Cementless Proximal Body, Modular Stem/Modular Revision Stem and Humeral Fracture Stem Implantation (FX)

NOTE: In cementless application, Modular Stem/Modular Revision Stem and Proximal Body are assembled in situ.

NOTE: Humeral Fracture Stems have a monoblock design and therefore don't need to be assembled. In order to implant Humeral Fracture Stems, connect the required Stem to the Handle for Compressors and Proximal Bodies and follow the workflow described in this chapter correspondingly.



Figure 4.113

Connect the required Modular Stem/Modular Revision Stem determined with the trial reduction to the Handle for Modular Stems (threaded connection).

Attach the Template for Proximal Bodies to the Handle. Introduce the Modular Stem/Modular Revision Stem into the humerus and impact until good stability is achieved.

Using the Template for Proximal Bodies, check the position of the final Modular Stem/final Modular Revision Stem.

NOTE: Another trial reduction can be performed at this stage (suggested in case the final Stem position differs from the Trial Stem position). Proximal Trial Bodies can be connected to the final Modular Stem/ final Modular Revision Stem in situ to determine the appropriate final Proximal Body height.

Remove the Handle and Template.
Remove the transportation lock (white plastic cover) from the final Proximal Body determined with the trial reduction.



Figure 4.114

NOTE: LINK Embrace Proximal Bodies and Modular Stems/Modular Revision Stems are fixed to each other by a taper connection. A pre-assembled locking screw inside the Proximal Body is used to tighten the coupling. This is done by means of a Torx 25 Screwdriverbit and a 5 Nm Torque Wrench. When pushing the Screwdriverbit into the locking screw, make sure the line mark for the respective height of the Proximal Body on the Screwdriverbit is at the level of the Handle impaction plate. This indicates that the Screwdriverbit is fully inserted into the locking screw head.



Figure 4.115

Connect the Proximal Body to the Handle for Compressors and Proximal Bodies and place it on the Modular Stem/Modular Revision Stem in situ. Do not impact.
Connect the Torx 25 Screwdriverbit to the 5 Nm Torque Wrench and slide it through the Handle into the head of the preassembled locking screw within the Proximal Body.

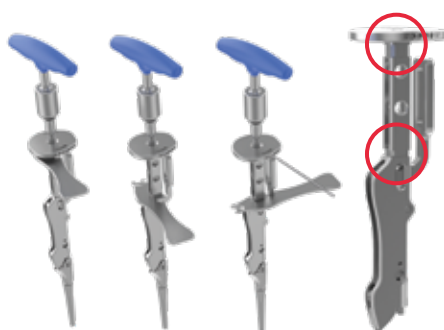

Figure 4.116

Slightly turn the locking screw just until the threaded connection of screw and Stem engages, leaving the Proximal Body freely rotatable on the Modular Stem. Align the required retroversion using the Alignment Rod screwed into the appropriate hole in the Handle impaction plate.

Alternatively, align the retroversion with the Alignment Rod screwed into the appropriate hole of the Alignment Rod Connector which is connected to the Handle.

Slide the Separator Wrench with its cut outs onto one of the recesses at the Handle. For convenient use, the Separator Wrench can be attached in several positions.



Figure 4.117

Tighten the locking screw within the Proximal Body using the 5 Nm Torque Wrench and the Torx 25 Screwdriverbit with your other hand firmly holding the Separator Wrench. The required torque is reached when a clicking noise can be heard. Remove Screwdriver and Handle.

Optionally, you may now perform another trial reduction with a Head Trial Adapter and Humeral Trial Head. Adapt the configuration if necessary. Place the required Head Adapter, reproducing the configuration selected in the trial reduction. For Head Adapters with offset, the same digit as the digit determined with the trial prosthesis must be aligned laterally.



Figure 4.118

NOTE: Neutral Head Adapters (offset 0 mm) are provided with and without circular holes to allow for tuberosities reattachment depending on surgeon's preference.



Figure 4.119

Insert the Fixation Screw into the Head Adapter (supplied with the Head Adapter).



Figure 4.120

Connect the Torx 25 Screwdriverbit to the 3 Nm Torque Wrench and slide it through the Counter Sleeve with the small Sleeve pin at the lower end.



Figure 4.121

Introduce the prepared Screwdriver into the Adapter Fixation Screw and position the Sleeve pin in the small hole in the Head Adapter.



Figure 4.122

Tighten the Screw by turning the Screwdriver clockwise while holding the Sleeve firmly in place with your other hand. The required torque of 3 Nm is reached when a clicking noise can be heard.

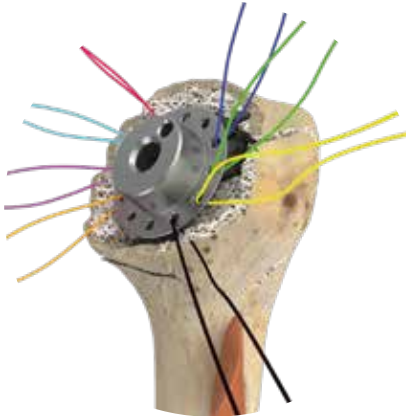

Figure 4.123

If required, attach sutures for tuberosities reattachment to the (neutral) Head Adapter at this stage.



Figure 4.124

If required, sutures can also be attached using the m-l and a-p holes of the Proximal Body.



Figure 4.125

Place the final Humeral Head with the required diameter and height onto the Head Adapter. Impact lightly using the concave Impactor for Humeral Heads and check the Head fixation manually.



Figure 4.126

Reduce the joint. If adjustments are necessary, both Humeral Head and Head Adapter can be removed with the Separator Wrench. When removing the Head Adapter, remove the Fixation Screw first. For further information on component removal, refer to chapter 8.

Go on with chapter 4.4.4.3.

4.4.4.2 Cemented Proximal Body, Modular Stem/Modular Revision Stem and Humeral Fracture Stem Implantation (FX)

NOTE: For cemented implantation, select the Modular Stem/Modular Revision Stem or the Humeral Fracture Stem (monoblock) one or two sizes smaller than the last Trial Stem or Humeral Fracture Trial Stem used. Modular Trial Stems/Fracture Trial Stems and final Modular Stems/final Humeral Fracture Stems with the same size designation have identical intramedullar stem dimensions. When selecting the final component one size smaller than the corresponding trial component, a cement mantle thickness of approx. 0.5 mm is achieved.

NOTE: In cemented application, Modular Stem/ Modular Revision Stem and Proximal Body are assembled on the sterile table. It is recommended to completely assemble the humeral component on the sterile table and insert it as a whole afterwards in axial alignment.

NOTE: Humeral Fracture Stems have a monoblock design and therefore don't need to be assembled. In order to implant Humeral Fracture Stems, connect the required Stem to the Handle for Compressors and Proximal Bodies and follow the workflow described in this chapter correspondingly.

The use of high viscosity cement is recommended for cementation.

Remove the transportation lock (white plastic cover) from the final Proximal Body determined with the trial reduction.

Connect the Proximal Body to the Handle for Compressors and Proximal Bodies.
Connect the Proximal Body to the required Modular Stem/Modular Revision Stem and tighten the locking screw within the Proximal Body as described in chapter 4.4.4.1.
Connect the Template for Proximal Bodies to the Handle.

Clean the bone using jet or pulse lavage and apply the cement.

Insert the assembled humeral component into the soft cement taking into account the desired retroversion.

For this purpose, the Alignment Rod is screwed into the appropriate hole in the Handle impaction plate rim. Make sure to select the correct set of holes for left and right side treatment.



Figure 4.127



Figure 4.128

Alternatively, place the Alignment Rod Connector on the Handle and insert the Alignment Rod in the appropriate hole. Make sure to select the correct position of the Alignment Rod Connector for left and right side treatment.



Figure 4.129

Manually press down the humeral component into the soft cement until the Template for Proximal Bodies indicates the previously defined component level. Remove excessive bone cement. With the Handle, the prosthesis is held in position until the cement is cured.

Remove the Handle.
Align and fix both Head Adapter and Humeral Head as described in 4.4.4.1.

Go on with chapter 4.4.4.3.

4.4.4.3 Tuberosity Refixation

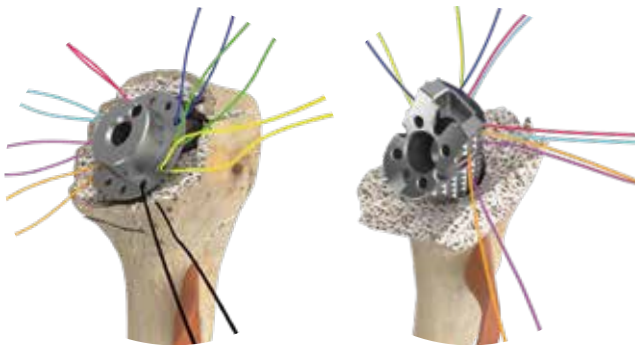

Figure 4.130

For the refixation of the tuberosities with surgical sutures, the circular drill holes of the neutral Head Adapter (0 mm offset) can be used.

All Proximal Bodies have holes for tuberosity refixation using suture material on the anterior and posterior side in m-l orientation, additionally lateral in a-p orientation. Medially, the suture material is positioned and held in recesses.

Tuberosity refixation is carried out according to the requirements defined by the surgeon.

4.5 CTA

4.5.1 CTA Head Preparation and Implantation

NOTE: LINK Embrace System CTA Heads have a male taper allowing for direct connection to Humeral Standard and Short Stems, Proximal Bodies, monoblock Fracture Stems and Stemless Cages. For Stemless Ring Cages, a specific adapter is available (refer to 4.5.2). CTA heads are available in versions as follows:

CTA Head		Combinations with Stemless Cages/Stemless Ring Cages	
Size	Height		
44	16	✓ sizes 30 - 38	✗ size 40
47	17	✓ all sizes	
50	18	✓ all sizes	
53	19	✓ all sizes	

Table 4.1: Allowed CTA Head-Stemless Cage/Stemless Ring Cage combinations are marked in green. Red combinations are not allowed. Numerical data in mm.

The resection level for the extended articulating surface of the CTA Heads is determined with an appropriate Humeral Trial Head of the above mentioned diameter/height combinations. Slots in the Trial Head indicate the resection level.



Figure 4.131

Place the neutral Head Trial Adapter on the humeral trial component or the already implanted humeral component with the cut, straight edge parallel to the humeral component surface. In case other components, e.g. a Head Adapter with offset or a Reverse Tray, have been connected to the humeral component beforehand, remove these as described in chapter 8. Remove the locking screw first.



Figure 4.132

Place the appropriate Trial Head selected acc. to table 4.1 on the neutral Head Trial Adapter.



Figure 4.133

Perform a trial reduction and adapt the configuration if necessary.
Mark the resection level for the lateral humerus by means of the horizontal Trial Head slots, e.g. using electro cautery.



Figure 4.134

Remove the Trial Head and the Head Trial Adapter. Resect the bone as marked with an oscillating saw.



Figure 4.135

Place the required CTA Head on the humeral component and impact.

Perform final reduction and check.
If adjustments are necessary, the CTA Head can be removed.
For further information on component removal, refer to chapter 8.

4.5.2 Stemless Ring Cages and CTA Heads



Figure 4.136

For combining a Stemless Ring Cage and a CTA Head, use the Stemless Ring Cage CTA Head Adapter.

In case the Stemless Ring Cage hosts a Reverse Insert, remove this using an appropriate instrument, e.g. a small chisel. For further information on component removal, refer to chapter 8.



Figure 4.137

Insert the Stemless Ring Cage CTA Head Adapter into the Stemless Ring Cage.



Figure 4.138

The resection level for the extended articulating surface of the CTA Heads is determined with the Humeral Trial Heads of the above mentioned diameter/height combinations shown in table 4.1. Place the required Trial Head on the Stemless Ring Cage. Manually align the Trial Head appropriately in terms of centering and rotation. The Trial Head cut-out has to be laterally at the highest point.



Figure 4.139

Mark the resection level for the lateral humerus by means of the horizontal Trial Head slots, e.g. using electro cautery.



Figure 4.140

Remove the Trial Head.
Resect the bone as marked with an oscillating saw.
Avoid any interference of the saw blade and the component in situ.



Figure 4.141

Place the required CTA Head on the humeral component and impact.

Perform final reduction and check.
If adjustments are necessary, both CTA Head and Stemless Ring Cage CTA Head Adapter can be removed.

For further information on component removal, refer to chapter 8.

5. Total Shoulder Arthroplasty

This chapter describes the surgical technique for Total Shoulder Arthroplasty in Anatomic (Anatomic Elective) and Fracture configuration using

- Stemless Cages
- Stemless Ring Cages
- Humeral Short Stems
- Humeral Standard Stems
- Modular Stems with Proximal Bodies
- Modular Revision Stems with Proximal Bodies
- Humeral Fracture Stems
- Humeral Heads
- All Poly UHMWPE Glenoids
- Convertible Glenoids.

5.1 Humeral Head Resection

5.1.1 Intramedullary Alignment

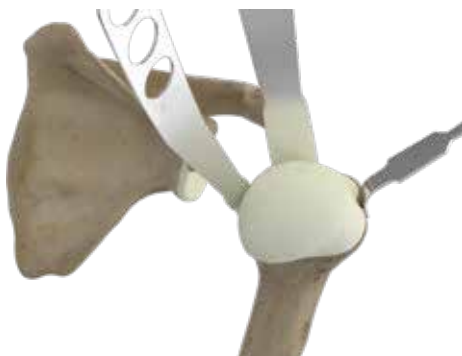

Figure 5.1

Expose and mobilize the humeral head and luxate it from the glenoid.



Figure 5.2

Open the medullary canal with a suitable instrument in line with the humeral axis.

NOTE: In case the implantation of a Stemless Cage/ Stemless Ring Cage is intended, it is recommended to perform the head resection using the extra-medullary alignment method (refer to 5.1.2).

Using the T-Handle, insert the Starter Awl into the medullary canal until the depth stop is reached. Make sure that the blue Depth Stop Disk rests in the Starter Awl shaft recess.



Figure 5.3

Prepare the Resection Guide depending on the surgical approach, i.e. selection of the Resection Block for delto-pectoral or for lateral approach.

NOTE: The LINK Embrace Instrument Set supports different surgical approaches. In the surgical technique described here, the delto-pectoral approach is used.

For lateral techniques use the Resection Block for lateral approaches and follow the workflow correspondingly.



Figure 5.4

Slide the Resection Guide down on the Starter Awl placed in the medullary canal by applying light pressure on the instrument spring clamp.



Figure 5.5

Connect the desired Resection Block and the Resection Guide Connector with the laser marks on both Connector Bar and Resection Block in line. The Resection Block is fixed to the Connector Bar by means of a magnetic connection.



Figure 5.6

Considering the side to be treated, insert the Resection Guide Connector into the fork of the Resection Guide. A slight initial resistance prevents the instrument from slipping out of the fork.



Figure 5.7

According to the desired retroversion, screw the Alignment Rod into the corresponding hole (0°, 10°, 20°, 30°) in the Alignment Rod Connector. Make sure to select the correct set of holes for treatment of the left or right side respectively, corresponding to the laser marking on the Alignment Rod Connector.

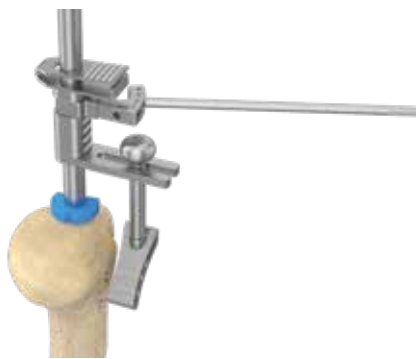

Figure 5.8

Place the Alignment Rod Connector with the Alignment Rod in the required orientation on the Resection Guide receptacle.



Figure 5.9

Set the desired retroversion by axially rotating the Resection Guide on the Starter Awl, adjusting the Alignment Rod parallel to the forearm which is held flexed at appr. 90°.

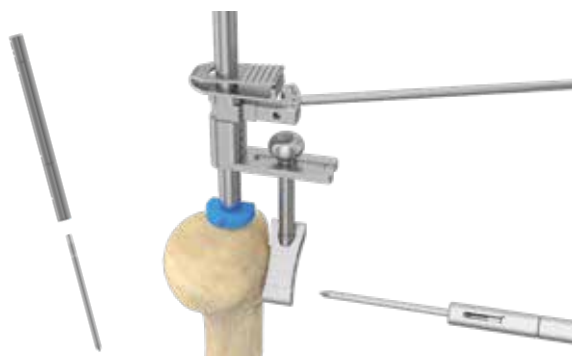

Figure 5.10

Adjust the Resection Guide to the desired resection level (to change the instrument level, press the instrument spring). The spring locks the instrument when released.

Finally determine the resection level with respect to the anatomical neck of the humeral head.

Push the Resection Block together with the Resection Guide Connector so that it slides within the fork until it gets into contact with the bone.

Fix the Resection Block with at least two Fixation Pins (3.0 mm) using the Universal Pin Inserter.

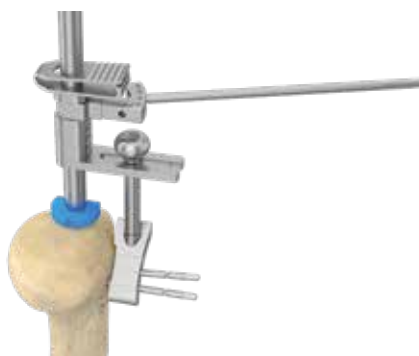

Figure 5.11

Outer pins run parallel and allow for sliding the Block on the pins. The central hole is oblique and locks the Resection Block position on the bone.

The orientation of the pinholes is marked accordingly on the Block. Take note that the most lateral pin might interfere with the intramedullary Starter Awl.



Figure 5.12

After final check of resection level and retroversion, the humeral head is resected with an oscillating saw blade on top of the Resection Block at 135° (defined by the instrument).

For this purpose, all instruments except the fixed Resection Block can be removed by pulling them upwards. To do so, press the spring on the Resection Guide, release the magnet connection between Resection Block and Resection Guide Connector and slide the Resection Guide upwards over the Starter Awl. Then remove the Starter Awl using the T-Handle.



Figure 5.13

For more stability, e.g. in case of poor fixation, the Resection Guide can also be left in place. When sawing, make sure to avoid any instrument interference.

The required Humeral Head diameter is now estimated using the Humeral Trial Heads, aiming at optimal coverage of the resection surface with the Trial Head.



Figure 5.14

Alternatively, the required head diameter and height can also be determined with the Sizing Gauge for Humeral Heads.

When using the Sizing Gauge, take into account any possible deformities of the natural head.

When selecting the suitable Humeral Head diameter in TSA, it is important to note that only certain Humeral Head and Glenoid Component sizes may be combined as shown in chapter 5.3.1., table 5.1.



Figure 5.15

Remove all instruments. Pins can be removed with the Pin Inserter/Extractor.

5.1.2 Extramedullary Alignment



Figure 5.16

Alternatively to intramedullary alignment and especially when Stemless Cages or Stemless Ring Cages are planned to be implanted, use the Resection Guide for extramedullary alignment. The extramedullary Resection Guide has a built-in angle of 135°.



Figure 5.17

According to the desired retroversion, screw the threaded end of the Alignment Rod into the corresponding hole (0°, 10°, 20°, 30°) on the vertical Resection Guide bar. The Guide has two opposing sets of holes for left and right application.



Figure 5.18

Align the rod-shaped neck of the instrument along the humeral shaft axis. A second Alignment Rod may be screwed into the hole at the distal Guide end, prolonging the instrument axis for easier positioning.



Set the desired retroversion by internal or external rotation of the Guide, adjusting the Alignment Rod parallel to the forearm which is held flexed at approx. 90°.

Figure 5.19



Determine the final resection level with respect to the anatomical neck of the humeral head. Fix the Resection Guide with at least two Fixation Pins (3.0 mm) using the Universal Pin Inserter. Outer pins run parallel and allow for sliding the Block on the pins. The central hole is oblique and locks the Resection Block position on the bone. The orientation of the pinholes is marked accordingly on the Guide.

Figure 5.20

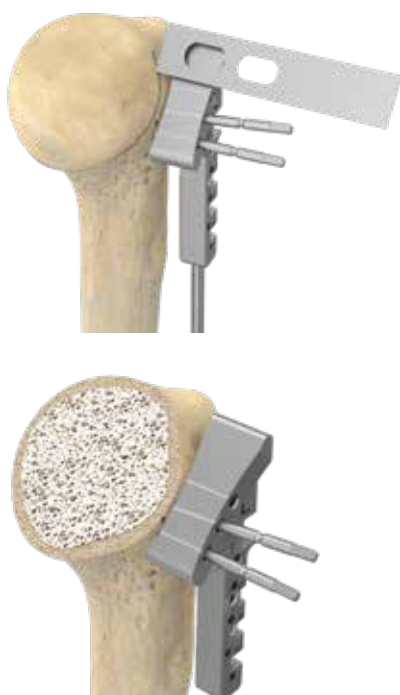

After final check of level and retroversion, resect the humeral head with an oscillating saw blade on top of the Resection Guide.

Figure 5.21

5.1.2.1 Alternative Retroversion Determination

The LINK Embrace Instrument Set supports an alternative way to determine the retroversion, using the Alignment Rod and the Alignment Rod Connector.



Figure 5.22

According to the desired retroversion, place the Alignment Rod into the corresponding hole (0°, 10°, 20°, 30°) in the Alignment Rod Connector. Make sure to select the correct set of holes for treatment of the left or right side respectively.

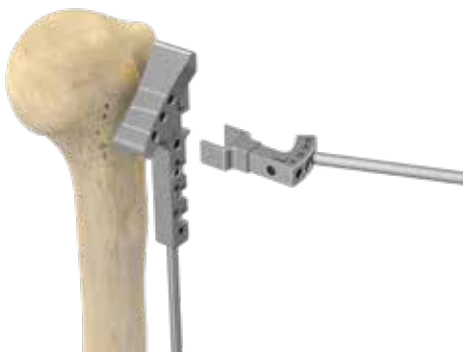

Figure 5.23

Place the Alignment Rod Connector with the Alignment Rod in the required orientation on the Resection Guide receptacle.

Go on as described in 5.1.2

5.2 Humerus Preparation

5.2.1 Stemless Cage/Stemless Ring Cage Preparation

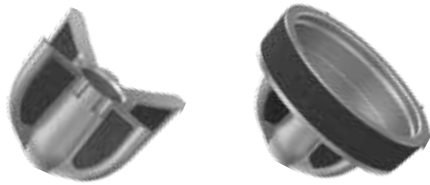

Figure 5.24

NOTE: The LINK Embrace System offers two types of Stemless Components: Stemless Cages (left) and Stemless Ring Cages (right).

Stemless Cages are used only for primary anatomical reconstruction with good bone quality in combination with LINK Embrace Head Adapters and Humeral Heads. In the case of later revision, they can be converted to a reverse configuration provided good bone integration has been achieved. Stemless Ring Cages can be used for primary anatomical and primary reverse treatment. These Cages are designed to either directly host the Reverse Inserts or to be combined with specific adapters for Humeral Heads and CTA Heads, allowing for anatomic reconstruction. All LINK Embrace Stemless Cages have a TrabecuLink surface, aiming at fast and stable component integration into the surrounding bone.



Figure 5.25

Resect the humeral head using the Extramedullary Resection Guide, taking into account the desired retroversion and the desired resection level as described in 5.1.2.



Figure 5.26

Determine the size of the Cage using the Sizer Disks. Place the Sizer Disk on the resection surface and check for best circumferential fit.

NOTE: Sizer Disks are available in sizes 30, 32, 34, 36, 38 and 40 mm.
 Stemless Cages are available in sizes 30, 32, 34, 36, 38, 40.
 Stemless Ring Cages are available in sizes 34, 36, 38, 40.
 Sizer Disks have exactly the same diameter as the corresponding implant.

NOTE: Stemless Cages/Stemless Ring Cages are designed to be implanted in cancellous bone.
 It is recommended to select the biggest component possible in each individual case.
 When positioning the Cage, make sure the Cage wings are not directly oriented towards the biceps tendon groove.

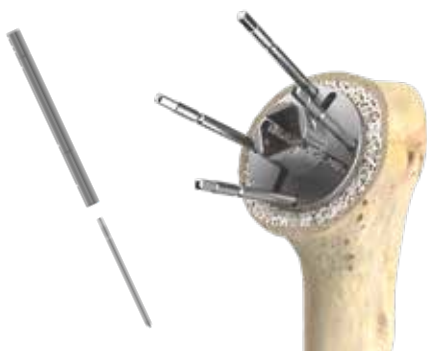

Figure 5.27

Position the appropriate Sizer Disk with optimal fit on the resection surface and slightly impact to fix it with the back pins in the bone.

Lock the Sizer Disk with at least two additional, opposite Fixation Pins through the pin holes at the Sizer Disk edge, using the Universal Pin Inserter.



Figure 5.28

Place the Sizer Sleeve for K-Wires on the Sizer Disk.



Figure 5.29

Push the K-Wire for Stemless Cage preparation (\varnothing 2.7 mm) through the Sizer Sleeve into the bone. Stop advancing the K-Wire upon cortical contact.

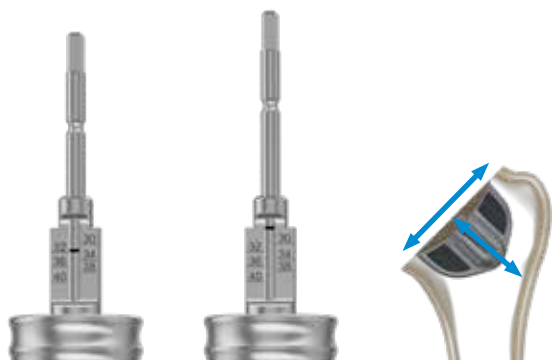

Figure 5.30

Check the laser mark on the K-Wire within the window of the Sizer Sleeve shaft. The mark indicates the biggest possible size of the Stemless Cage/ Stemless Ring Cage. In case the K-Wire laser mark is at the level or below the size 30 mark (on the window scale, figure/left), the humerus is big enough to host the Stemless Cage/Stemless Ring Cage of the size indicated. If the K-Wire mark is above the mark for size 30 (figure/middle), the humerus is too small to host a Stemless Cage. In this case, consider to use a stemmed component.



Figure 5.31

Remove the K-Wire with the Pin Inserter/Extractor. Replace the Sizer Sleeve for K-Wires with the Center Sleeve for the Central Peg Punch.



Figure 5.32

Drive the Central Peg Punch through the Sizer Disk and impact until the depth stop is reached.



Figure 5.33

Remove the Central Peg Punch and the Center Sleeve. Screw the Punch/Trial Cage for Stemless Cages of the same size as the Sizer Disk used onto the Impactor for Stemless Cages/Ring Cages. Make sure the Depth Stop Disk rests in the Impactor shaft recess.



Figure 5.34

Drive the Punch/Trial Cage for Stemless Cages through the Sizer Disk until the depth stop is reached.

5.2.1.1 Stemless Cage Preparation



Figure 5.35

Unscrew the Impactor from the Punch/Trial Cage, leaving the Punch in situ. Remove the Fixation Pins and the Sizer Disk using the Pin Inserter/Extractor.

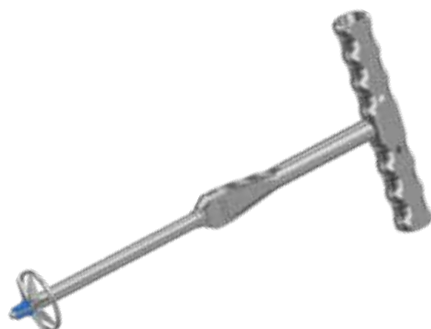

Figure 5.36

Connect the Finishing Reamer to the T-Handle (Hudson fitting).



Figure 5.37

Ream the humeral resection surface with the Finishing Reamer connected to the T-handle and create a concave surface. To do so, insert the blue Reamer guiding Sleeve into the female taper of the Punch/Trial Cage and align axially.

Ream manually until the depth stop is reached. Remove the Reamer.

Leave the Punch in situ. This serves as a Trial Cage and is used for trial reduction in the next step. Go on with chapter 5.3.

5.2.1.2. Stemless Ring Cage Preparation



Figure 5.38

Remove the Punch/Trial Cage using the Impactor for Stemless Cages/Stemless Ring Cages. Remove the Fixation Pins and the Sizer Disk using the Pin Inserter/Extractor.



Figure 5.39

Screw the Punch/Trial Cage for Stemless Ring Cage of the same size as the Sizer Disk used onto the Impactor for Stemless Cages/Stemless Ring Cages.



Figure 5.40

Align the Punch/Trial Cage with the prepared implant bed and impact until the upper surface of the Punch ring is flush with the resection plane.



Figure 5.41

Connect the Reamer for Stemless Ring Cage preparation to the T-Handle in order to remove the cancellous bone within the Punch ring. Alternatively, compact the bone with an appropriate instrument.



Figure 5.42

Ream and remove the bone until the depth stop is reached.

Leave the Punch in situ. This serves as a Trial Cage and is used for trial reduction in the next step. At this stage, you may use the bone removed with the Reamer and press it into the cancellous bone cavities for interdigitation.

Go on with chapter 5.3.

5.2.2 Humeral Standard and Short Stem Preparation

NOTE: The LINK Embrace System offers Humeral Stems in two different lengths: Humeral Standard Stems with 100 mm and Humeral Short Stems with 75 mm length. For both ranges dedicated humeral Compressors are used. Compressors are 5 mm longer than the corresponding Stems.



Figure 5.43

Medullary canal preparation is started with the smallest Compressor (size 12) in the required length (75 mm or 100 mm).

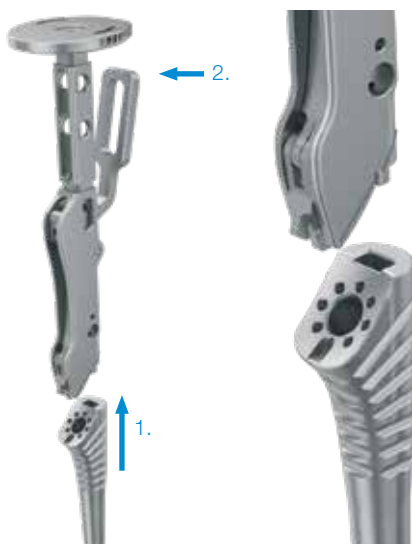

Figure 5.44

Connect the Compressor to the Handle for Compressors and Proximal Bodies by opening the Handle lever and inserting the nose piece at the end of the Handle into the Compressor's groove located laterally. Close the Handle lever, locking the Compressor firmly to the Handle.

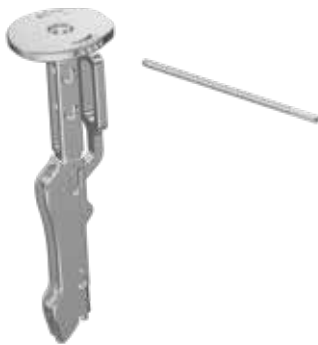

Figure 5.45

According to the desired retroversion, screw the threaded end of the Alignment Rod into the corresponding hole (0°, 10°, 20°, 30°) in the rim of the Handle impaction plate. Make sure to select the correct set of holes for treatment of the left or right side respectively.



Figure 5.46

Alternatively, the Alignment Rod may be used together with the Alignment Rod Connector to determine the desired retroversion as described in 5.1.1.

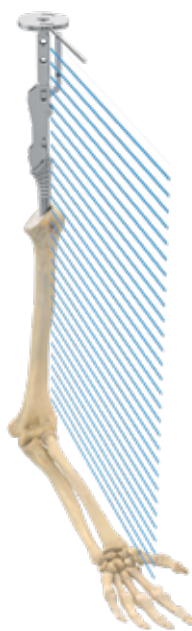

Figure 5.47

Insert the Handle with the Compressor into the humeral shaft. Set the desired retroversion by axially rotating the Handle, adjusting the Alignment Rod parallel to the forearm which is held flexed at approx. 90°.



Figure 5.48

Gradually prepare the humeral canal until the size determined in the preoperative planning is reached. The Compressor has to be stable and the line mark on the Handle has to be flush with the resection surface (red circle). The Compressor is now slightly recessed within the bone.



Figure 5.49

Remove the Handle, leaving the last Compressor in situ.

Connect the Finishing Reamer with the T-Handle (Hudson fitting).



Figure 5.50

Ream the humeral resection surface with the Finishing Reamer and create a concave front face. To do so, insert the blue Reamer guide tip into the female taper of the humeral Compressor and align axially.



Figure 5.51

Ream manually until the depth stop is reached. Remove the Reamer.



Figure 5.52

Depending on the posterior head offset, choose the appropriate Humerus Protection Plate from two options: neutral or 6 mm offset version.

Place the selected Humerus Protection Plate on the resection surface with its peg in the central hole of the humeral component.

Depending on the preferred workflow, glenoid preparation can be performed immediately after humeral head resection. The Humerus Protection Plates can also be placed directly onto the bone and be fixed with the aid of the backside pins.

Go on with chapter 5.3.

5.2.3 Proximal Body, Modular Stem/Modular Revision Stem and Humeral Fracture Stem Preparation (FX)



Figure 5.53

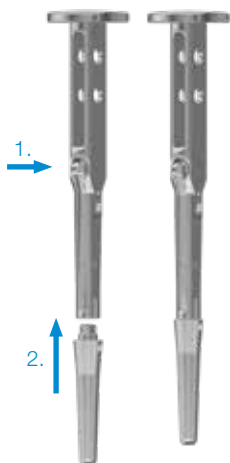

Figure 5.54



Figure 5.55

After removing the bone fragments, the required head diameter and height are determined using the head fragment and the Sizing Gauge for Humeral Heads.

Determine the appropriate diameter and length of the Modular Stem/Modular Revision Stem using the Modular Trial Stems, which are coupled to the Handle for Modular Trial Stems. To attach the Modular Trial Stem to the Handle, press the Handle lever.

Place the Trial Stem on the Handle and release the lever. For disassembly, press the lever again and remove the Trial Stem.

The selected Modular Trial Stem is carefully driven into the bone until good stability is achieved.

NOTE: To adjust the prosthesis height, the LINK Embrace Shoulder System offers Proximal Bodies and Trials in three different heights: -5, 0 and +5, each in three sizes: S, M and L. A Template for Proximal Bodies is used to determine the required Proximal Body height.

NOTE: The Template is used for both left and right side. To adapt the Template to the appropriate side, slide the Template plate on the Template bar into the circumferential recess. Rotate the Template plate by 90° and detach it from the Template bar. Depending on the side to be treated, flip the plate so that the front marking reads “left” or “right”. Reattach the plate to the bar by sliding it over the flattened bar end into the recess. Rotate the plate by 90° and slide it on the Template bar.

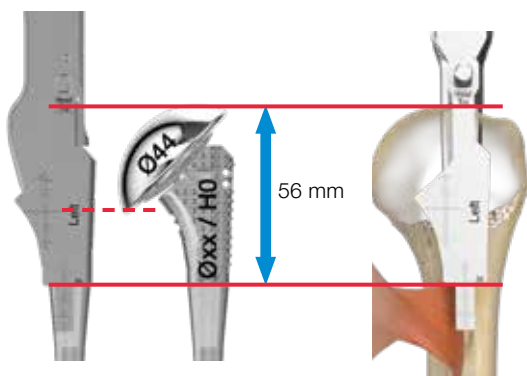

Figure 5.56

NOTE: To determine the required height of the Proximal Body, the Template for Proximal Bodies references to the proximal insertion of the Pectoralis Major m., which is approximately 56 mm below the highest point of the humeral head.

The Template contour corresponds to the Proximal Body of height “0” and size “S”.

The upper line mark on the Template indicates the height of a Humeral Head with a diameter of 44 mm and a height of 16 mm. The lower end of the scale is 56 mm below the upper line mark. The position of the scale end relative to the insertion can be used to determine if a different Modular Stem (length and size) and/or a higher Proximal Body has to be used.



Figure 5.57

Check the correct height level of the Stem considering the required height of the Proximal Body. To do so, attach the Template for Proximal Bodies to the Handle for Modular Trial Stems by inserting the Template bar and pin into the corresponding grooves located on the Handle. A magnetic connection fixes the Template bar to the Handle.



Figure 5.58

Connect the Handle to the Trial Stem in situ and refer to the insertion of Pectoralis Major m. as described. In case the required level can not be achieved with the different Proximal Body heights available, adapt the level of the Modular Trial Stem. To do so, it may be necessary to select a Modular Trial Stem of a different size and/or length.



Figure 5.59

Once an appropriate Trial Stem has been inserted, remove the Handle for Modular Trial Stems. Connect the Proximal Trial Body with height “0” and size “M” to the Handle for Compressors and Proximal Bodies.

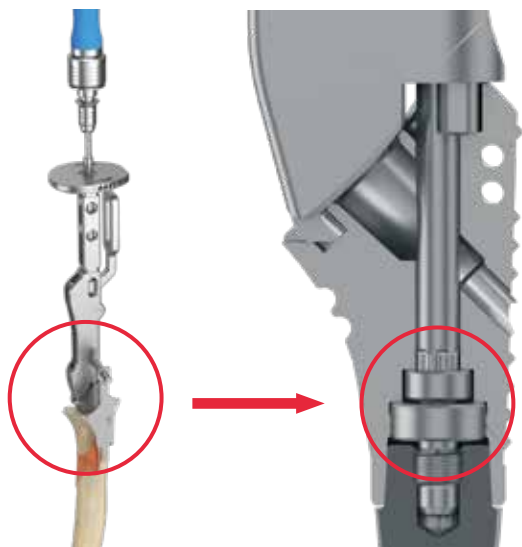

Figure 5.60

Place the Proximal Trial Body on the Modular Trial Stem located in situ.
 Connect the Torx 25 Screwdriverbit to the Ratchet and push it through the cannulated Handle into the Proximal Trial Body. Make sure the Screwdriverbit fully engages into the head of the preassembled locking screw within the trial component.



Figure 5.61

Tighten the locking screw slightly with the Ratchet to create the connection between Modular Trial Stem and Proximal Trial Body.
 According to the desired retroversion, screw the threaded end of the Alignment Rod into the corresponding hole (0°, 10°, 20°, 30°) in the rim of the Handle impactation plate. Make sure to select the correct set of holes for treatment of the left or right side respectively.

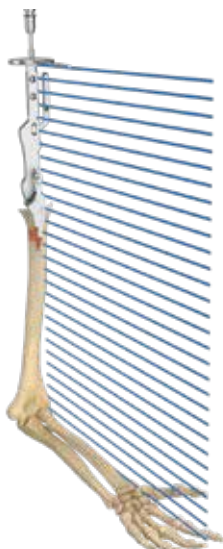

Figure 5.62

Alternatively, use the Alignment Rod together with the Alignment Rod Connector to determine the desired retroversion as described in 5.1.1.
 Set the desired retroversion by axially rotating the Handle, adjusting the Alignment Rod parallel to the forearm which is held flexed at approx. 90°. To do so, slightly loosen the locking screw within the Proximal Trial Body.

Once the desired retroversion has been adjusted, tighten the screw and remove both Screwdriver and Handle.

Go on with chapter 5.3.

5.3 Glenoid Preparation (for Cemented All Poly and Convertible Glenoids)

NOTE: Prior to glenoid preparation, visually check the scapula bone stock for appropriate integrity. In case the bone stock is not sufficient, measures have to be considered to allow for alternative appropriate component fixation.

5.3.1 Glenoid Sizing and Positioning

Relocate the humerus posterior-caudally with the help of a double fork retractor or a Fukuda retractor. Excise labrum and osteophytes to expose the glenoid.



Figure 5.63

Select the Glenoid Sizer according to the required glenoid size (small (S), medium (M), large (L), extra large (XL), each in left and right version) and connect it to the Guide Handle for K-Wire so that the two Guide noses click into the grooves of the Glenoid Sizer (magnetic connection).

NOTE: When determining the required glenoid size with the Sizer, select a suitable Head-Glenoid pairing according to the following table

Glenoid Size	Curvature Diameter	Head Size					
		38	41	44	47	50	53
small	52	✓	✓	✓	✓	✗	✗
medium	58	✓	✓	✓	✓	✓	✓
large	64	✗	✗	✓	✓	✓	✓
x-large	64	✗	✗	✓	✓	✓	✓

Table 5.1: Allowed Head-Glenoid combinations are marked in green. Red combinations are not allowed. Numerical data in mm.



Figure 5.64

Place the Glenoid Sizer of the appropriate side and size on the glenoid. Position the Sizer according to your preferences and check the size. The Sizer must not overlap the glenoid rim.

With a power tool, place a K-Wire for glenoid preparation (\varnothing 2.5 mm) through the central Guide hole into the glenoid bone.



Figure 5.65

After removal of the Sizer, visually check the correct position of the K-Wire.



Figure 5.66

In case repositioning is necessary, use the Repositioner for K-Wires.

The Repositioner for K-Wires allows for parallel shifting the K-Wire in 3, 4 and 7 mm distance. Depending on the required offset, slide the Repositioner over the K-Wire through the corresponding hole down to the glenoid and align the offset.

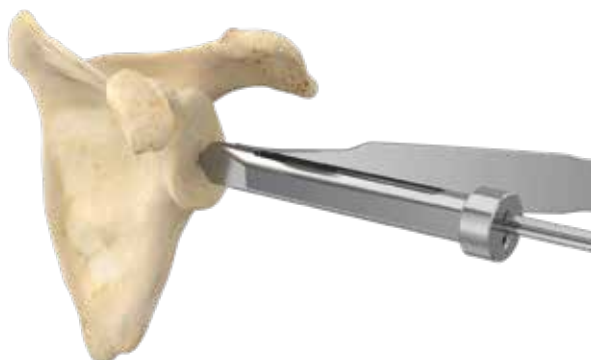

Figure 5.67

Insert a second K-Wire through the specified lumen.

After removal of the Repositioner, visually check the correct position of the K-Wire.

Remove the initially positioned K-Wire with the Pin Inserter/Extractor.

5.3.2 Glenoid Reaming



Figure 5.68



Figure 5.69



Figure 5.70

Corresponding to the four sizes of the Glenoid Sizers, four sizes of the Glenoid Reamers are provided. The bony preparation of the glenoid is carried out with the Glenoid Reamers of the corresponding size (S, M, L, XL).

NOTE: LINK Embrace Glenoid Reamers have a slotted central hole, allowing for slightly tilting the Reamer on the K-Wire. A cut out at the outer Reamer ring facilitates passing the surrounding soft tissue and, thus, pushing the Reamer down to the glenoid.

Select the Glenoid Reamer of the appropriate size. Tilt and slide it over the K-Wire down to the glenoid. Slide the cannulated Drive Shaft for glenoid preparation (with the Tissue Protection Sleeve installed) over the K-Wire and insert it into the situs. Connect the Drive Shaft to the Glenoid Reamer in situ. To do this, insert the external hexagon of the Drive Shaft into the internal hexagon of the Reamer (magnetic connection).

Carefully ream the glenoid. For manual reaming, connect the T-Handle to the Drive Shaft employing the Hudson fitting.

NOTE: Take into account the stability of the bone. Avoid applying excessive forces and overreaming of the glenoid. It is recommended to carefully place the reamer onto the glenoid. When using a power tool, have it already rotating before contact.

After reaming, remove Drive Shaft and Glenoid Reamer in reverse order. The K-Wire remains in situ.

Go on with chapter 5.3.3 for Cemented All Poly Glenoids or chapter 5.3.4 for Convertible Glenoids.

5.3.3 Cemented All Poly Glenoid

5.3.3.1 Cemented All Poly Glenoid Preparation

NOTE: LINK Embrace Cemented All Poly Glenoids come in four sizes. They have identical back radii, peg diameters and peg positions. This allows for uncomplicated change of the initially planned glenoid size without changing the bone preparation. When changing from smaller to larger sizes, avoid the implant overlapping the native glenoid edges.



Figure 5.71

Drill the central hole for the Central Glenoid Peg. To do so, fit the Drill for Central Pegs of Cemented Glenoids on the Drive Shaft (hexagonal magnet connection) and slide it over the K-Wire down to the glenoid. Drill until the depth stop is reached.

Remove the Drill and the K-Wire.



Figure 5.72

Connect the Handle for Glenoid Sizers and Drill Templates to the Drill Template for Peripheral Pegs of Cemented All Poly Glenoids and insert it into the situs.

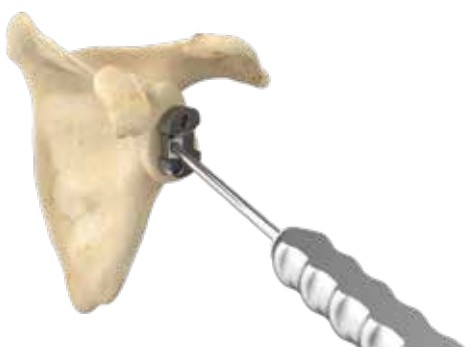

Figure 5.73

Introduce the rear central peg of the Drill Template into the central hole within the glenoid.

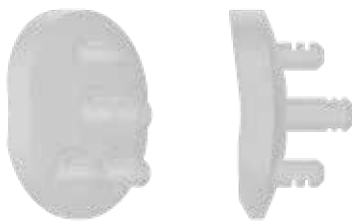

Figure 5.74

NOTE: LINK Embrace Cemented All Poly Glenoids have 3 peripheral pegs: two inferiorly and one superiorly (figure). Glenoid Drill Templates and PE Glenoid components must be aligned accordingly.

NOTE: LINK Embrace Cemented All Poly Glenoids have a chamfered inferior rim to reduce the risk of impingement in close adduction of the arm. When implanting, make sure the All Poly Glenoid is aligned in the correct way (with the chamfer and the 2 peripheral pegs inferiorly).

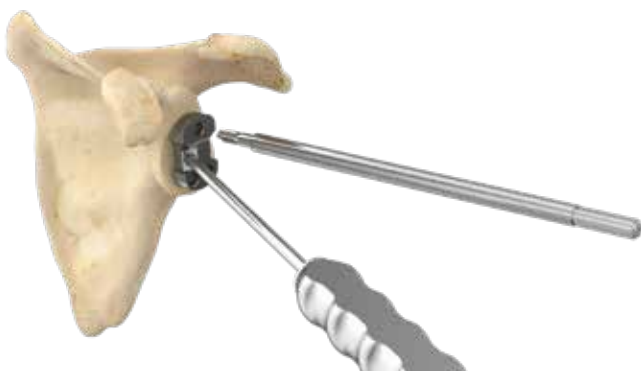

Figure 5.75

Align the Drill Template, i.e. to ensure complete seating and correct inferior-superior alignment. Drill the superior peripheral hole for the superior Glenoid peg. To do so, fit the Drill for Peripheral Glenoid Pegs on the Drive Shaft (hexagonal magnet connection) and drill through the superior hole of the Drill Template until the depth stop is reached.



Figure 5.76

Remove the Drill and insert the Fixation Pin for Drill Templates with the Pin Inserter. Fixation Pin and hole have a tight fit. Drill the two inferior peripheral holes.



Figure 5.77

Remove all instruments.



Figure 5.78

Insert the Trial for Cemented All Poly Glenoids in the desired size using the Insertion Forceps. Final check of the complete seating and alignment.

A trial reduction can be performed (with completed humerus preparation and trial components in place).

5.3.3.2 Cemented All Poly Glenoid Implantation



Figure 5.79

Clean the central and peripheral drill holes for Glenoid Pegs using pulse/jet lavage and dry the bone surface in the drill holes, e.g. with a compress pressed into the drill holes using tweezers. Press the prepared, high viscosity bone cement into all drill holes.



Figure 5.80

Implant the desired Cemented All Poly Glenoid with the convex Impactor for Reverse Inserts and PE Glenoids.

In case excessive bone cement appears, remove it. With the convex Impactor, hold the glenoid component in position until the cement is cured.

5.3.4 Convertible Glenoid

5.3.4.1 Convertible Glenoid Preparation

NOTE: Convertible LINK Embrace Glenoids come in four sizes. They have identical back radii, peg diameters and peg positions. This allows an uncomplicated change of the originally planned glenoid size without changing the bone preparation. When changing from smaller to larger sizes, avoid the implant overlapping the native glenoid edges.

NOTE: The implant anchors in the bone using press-fit. If required, LINK Embrace Convertible Glenoid Metal-Backs can additionally be fixed to the bone by means of a central cancellous Bone Screw.



Figure 5.81

Drill out the central hole for the central peg of the Glenoid Metal-Back with the Central Drill for Reverse Glenoid Baseplate and Metal-Back for Convertible Glenoids over the K-Wire. To do this, attach the Drill to the Drive Shaft for glenoid preparation. Drill until the depth stop is reached.



Figure 5.82

Remove the Drill and the K-Wire. Connect the Handle for Glenoid Sizers and Drill Templates to the Drill Template for Convertible Metal-Back and insert it into the situs.



Figure 5.83

Introduce the rear central peg of the Drill Template into the central hole within the glenoid.



Figure 5.84

Align the Drill Template, ensuring full seating and correct inferior/superior alignment.
Drill the superior peripheral hole through the Template with the Drill for Peripheral Pegs. Drill until the depth stop is reached.



Figure 5.85

Remove the Drill and insert the Fixation Pin for Drill Templates with the Pin Inserter. Fixation Pin and hole have a tight fit.
Drill the inferior peripheral hole.



Figure 5.86

Remove all instruments.

5.3.4.2 Convertible Glenoid Implantation



Figure 5.87

Slide the threaded Shaft for Impactor into the Impactor. Turn it clockwise to pass the safety thread that prevents the Shaft from slipping out of the Impactor sleeve.



Figure 5.88

Place the Metal-Back of the required size on the Impactor with the pins of the two Impactor legs in the peripheral peg cavities of the Metal-Back. Fix the Metal-Back to the Impactor by turning the Shaft clockwise. To do so, use the Torx 20 Screwdriverbit connected to the Ratchet. When assembled properly, the central Impactor flange lies flat on the Metal-Back surface.



Figure 5.89

Remove the Screwdriverbit and Ratchet. Insert the Metal-Back into the situs with the pegs into the corresponding bone holes. Impact the component carefully until its back side is in full contact to the bone surface.



Figure 5.90

Remove the instrument by unscrewing the Impactor Shaft using the Torx 20 Screwdriverbit and the Ratchet.

5.3.4.3 Central Screw Implantation

NOTE: If required, LINK Embrace Metal-Backs for Convertible Glenoids can be fixed with a central Bone Screw. For this purpose, cancellous cylinder head Bone Screws with Ø 6.0 mm in lengths of 15, 20, 25 and 30 mm are available.



Figure 5.91

Insert the Drill Guide for central Screws into the Metal-Back's central hole. The drill guide determines the direction of the screw. Drill the screw hole with the Ø 3.2 mm drill bit to the desired depth.



Figure 5.92

The required screw length is determined with the Depth Gauge.

The cancellous cylinder head Bone Screw of the desired length is inserted with the Torx 25 Screwdriverbit connected to the Ratchet and screwed in until it is fully seated.

NOTE: Make sure the Bone Screw is fully seated. Go on tightening the Bone Screw until the laser mark on the Screwdriverbit is level with the Metal-Back surface, indicating the Bone Screw is in the required position.

NOTE: Care must be taken to not overtighten the central Bone Screw as this might impair the fixation of the Screw or damage the bone.

5.3.4.4 Implantation of Glenoid Inserts for Convertible Glenoids

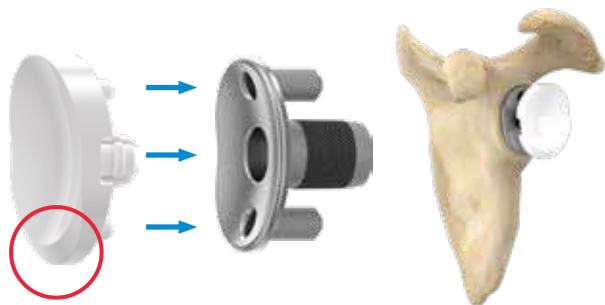

Figure 5.93

Select the UHMWPE Glenoid Insert for Convertible Glenoids of the same size as the implanted Metal-Back. Inserts are available in standard UHMWPE and E-Dur UHMWPE (Vitamin E infused crosslinked UHMWPE) and come in four sizes small (S), medium (M), large (L) and x-large (XL), corresponding to the sizes of the Metal-Back.

Clean the previously implanted Metal-Back with pulse- or jetlavage.

The required Glenoid Insert is placed on the Metal-Back by hand, wherein the chamfered edge of the Glenoid Insert is to be positioned inferiorly and the pegs of the UHMWPE component are to be aligned with the corresponding Metal-Back holes.



Figure 5.94

Impact the UHMWPE-Glenoid Insert with the convex Impactor for Reverse Inserts and PE Glenoids.



Figure 5.95

The Glenoid Insert is fully seated as soon as its bone-side rim is completely covering the Metal-Back rim.

5.4 Humeral Components: Trialing

5.4.1 Stemless Cage Trialing



Figure 5.96

Select the suitable Humeral Trial Head (diameter and height).

NOTE: The LINK Embrace System includes Humeral Heads and trial components in various diameters and heights. Furthermore, different Head Adapters and trial components with different offsets (eccentricities) are available for reconstruction of the individual anatomy. It is recommended to start with a neutral Head Trial Adapter and a medium height Trial Head.



Figure 5.97

Firmly push the neutral Head Trial Adapter into the Punch. A spring-loaded clamp connection fixes the Head Trial Adapter to the Punch.



Figure 5.98

Place the Trial Head on the Head Trial Adapter. These are fixed to each other by a magnetic connection. Assess the coverage of the resection plane.

NOTE: The Punch/Trial Cage for Stemless Cages can only accept neutral (concentric) Head Trial Adapters. In case a Head Adapter with offset is required, implant the final Stemless Cage first. Then determine the Head Adapter's eccentricity and orientation in the way described in the subsequent note.

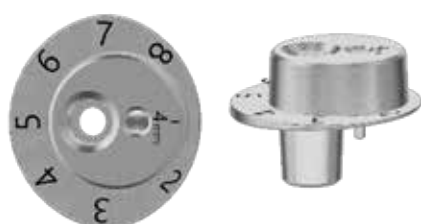

Figure 5.99

NOTE: If required, coverage can be optimized by selecting a Head Trial Adapter with offset (available in 2, 4 and 6 mm offset). Head Trial Adapters (alike the final Head Adapters with offset, refer to figure) have a rear pin that is inserted into one of the holes in the humeral component front face and allows adjustment in 45° steps.



Figure 5.100

Head Trial Adapters and final Head Adapters have a dial-like ring, used to precisely determine and reproduce the selected position. For this purpose, the most laterally located digit on the Head Trial Adapter is noted and the final Head Adapter is later on positioned accordingly with the same digit most laterally (e.g. in the figure the most laterally digit is “1” in a 4 mm offset Head Trial Adapter/Head Adapter). For easier identification of the Head Trial Adapter position, Trial Heads have the same dial-like ring at the rim.

Check the required Head height referring to the anatomical landmarks and, if necessary, correct with more suitable Head heights.

Perform a trial reduction to check stability, tension and function of the joint. If necessary, adjust the configuration using a more suitable Head Trial Adapter (only in combination with final Stemless Cage implanted) and/or Trial Head.

Remove the trial components manually, leaving the Punch/Trial Cage in situ.

Go on with chapter 5.5.1.

5.4.2 Stemless Ring Cage Trialing

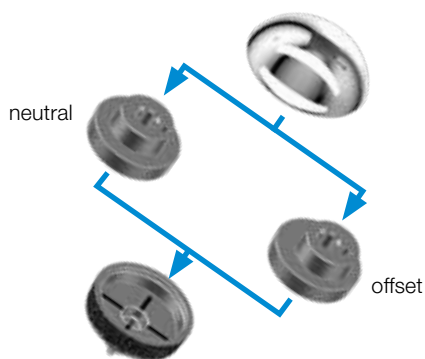

Figure 5.101

NOTE: Stemless Ring Cages can be used for anatomic reconstruction with Humeral Heads by means of Stemless Ring Cage Head Adapters. These are provided in neutral and 2 mm offset version.

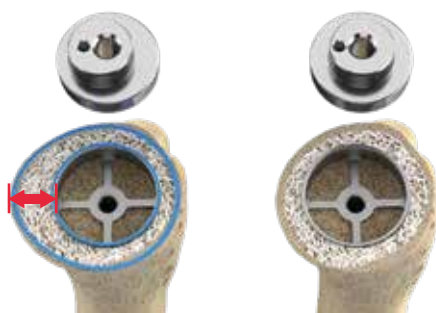

Figure 5.102

Assess the degree and orientation of deviation from the central position. In case the Punch/Trial Cage is well centered, select the neutral Adapter. Otherwise, select the offset Adapter and define the direction of the eccentricity, aiming at optimal Head coverage. Mark the eccentricity (arrow) on the bone, e.g. using electro cautery.



Figure 5.103

Place the Trial Head directly on the resection surface.
 Assess the coverage of the resection plane and the head height and select the required Humeral Head accordingly (diameter and height).

Go on with chapter 5.5.2.

5.4.3 Humeral Standard & Short Stem Trialing



Figure 5.104

Remove the Humerus Protection Plate.
 Select the suitable Humeral Trial Head (diameter and height).

NOTE: The LINK Embrace System includes Humeral Heads and trial components in various diameters and heights. Furthermore, different Head Adapters and trial components with different offsets (eccentricities) are available for reconstruction of the individual anatomy. It is recommended to start with a neutral Head Trial Adapter and a medium height Trial Head.



Figure 5.105

Firmly push the neutral Head Trial Adapter (0 mm offset) into the Compressor. A springloaded clamp connection fixes the Adapter to the Compressor.



Figure 5.106



Figure 5.107



Figure 5.108

Place the Trial Head onto the Head Trial Adapter. These are fixed to each other by a magnetic connection.
Assess the coverage of the resection plane.

NOTE: If required, coverage can be optimized by selecting a Head Trial Adapter with offset (available in 2, 4 and 6 mm offset). Head Trial Adapters (like the final Head Adapters with offset, refer to figure) have a rear pin that is inserted into one of the holes in the humeral component front face and allows adjustment in 45° steps.

Head Trial Adapters and final Head Adapters have a dial-like ring, used to precisely determine and reproduce the selected position. For this purpose, the most laterally located digit on the Head Trial Adapter is noted and the final Head Adapter is later on positioned accordingly with the same digit most laterally (e.g. in the figure the most laterally digit is “3” in an 4 mm offset Head Trial Adapter/Head Adapter). For easier identification of the Head Trial Adapter position, Trial Heads have the same dial-like ring at the rim.

Check the required Head height referring to the anatomical landmarks and, if necessary, correct with more suitable Head heights.

With the Trial Head in place, perform a trial reduction to check the stability, tension and function of the joint.

If necessary, adjust the configuration using a more suitable Head Trial Adapter and/or Trial Head.

In case a Head Trial Adapter with offset is used, the laterally located digit on the Adapter is to be noted as described above in order to identically reproduce the position with the final component later on.

Remove the trial components manually.

Remove the Compressor using the Handle.

Go on with chapter 5.5.3.

5.4.4 Proximal Body, Modular Stem/Modular Revision Stem and Humeral Fracture Stem Trialing (FX)



Figure 5.109

NOTE: It is generally recommended to start the trial reduction with a neutral Head Trial Adapter combined with Humeral Trial Head determined with the Sizing Gauge for Humeral Heads.

NOTE: Neutral Head Adapters (offset 0 mm) are provided with (figure) and without circular holes to allow for tuberosities reattachment depending on surgeon's preference.



Figure 5.110

Firmly press the neutral Head Trial Adapter (0 mm offset) into the Proximal Body or the Humeral Fracture Stem (monoblock) respectively.



Figure 5.111

Place the required Humeral Trial Head on the Head Trial Adapter.

5.4.4.1 Proximal Body, Modular Stem/Modular Revision Stem Trialing (FX)



Figure 5.112

Perform a trial reduction and, if necessary, adjust the selected trial components and the alignment.

Both the Head Trial Adapter and the Trial Head have a cut out. Align both cut outs in lateral position to change the retroversion using the Screwdriver without removing the trial components. To do this, push the long Screwdriverbit, Torx 25, connected to the Ratchet, through the cut outs into the preassembled locking screw within the Proximal Trial Body and untighten it slightly. The retroversion can now be adjusted. Finally, retighten the locking screw and remove the Screwdriver. Repeat the trialing.



Figure 5.113

If no further adjustments are required, the selected retroversion can be marked on the bone, e.g. with electric cauter, according to the line markings on the Proximal Trial Body.

The implantation level can now also be transferred from the Template to the bone for orientation when implanting the final component.

Go on with chapter 5.5.4.1 (cementless implantation) or chapter 5.5.4.2 (cemented implantation).

5.4.4.2 Humeral Fracture Stem Trialing (FX)

NOTE: The LINK Embrace System offers monoblock Humeral Fracture Stems in sizes 12, 13, ..., 24 for simple and fast treatment of humeral fractures. The proximal shape of these monoblock Stems corresponds to a Proximal Body of height 0 (Proximal Bodies are available in three heights -5, 0 and +5, refer to 5.2.3), whereby the proximal diameter grows harmoniously with increasing size. Distally, monoblock Fracture Stems correspond to a Modular Stem of the same size with 75 mm length.

Trial components for sizes 12 and 13 come as a monoblock. For all other sizes, the humeral trial component is assembled using the corresponding size of the 75 mm Modular Trial Stem and the Proximal Trial Body with height 0 and size M. In consequence, assembled trial components and final components have slightly different volume in the proximal section. This must be taken into account for the subsequent reattachment of the tuberosities.

Prepare the humerus and determine the required diameter of the Modular Stem as described in 5.2.3.

For sizes 12 and 13, perform trial reduction with the Humeral Fracture Trial Stems (monoblock) provided.

For sizes 14 - 24, combine Modular Trial Stems L 75 mm of the required diameter with the Proximal Trial Body with height 0 and size M. Assemble the components as described in 5.2.3.

Determine the required height of the component. To do so, connect the Template for Proximal Bodies to the Handle for Compressors and Proximal Bodies and attach the Humeral Fracture Trial Stem to the Handle.

Go on as described in 5.2.3.

Assemble Head Trial Adapter and Humeral Trial Head as described in 5.4.4.

Perform the trial reduction as described in 5.4.4.1 correspondingly.

Go on with chapter 5.5.3.1 (cementless implantation) or chapter 5.5.3.2 (cemented implantation).

5.5 Humeral Components: Implantation

5.5.1 Stemless Cage Implantation

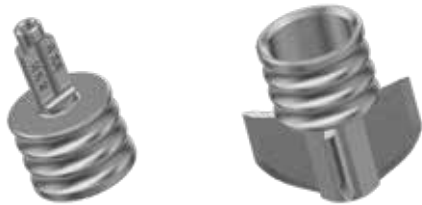

Figure 5.114

NOTE: Alternatively to assembling the component in situ as described here, the component can be completely assembled on the sterile table and impacted as a whole afterwards. In this case, follow the workflow described here correspondingly.

Introduce the Sizing Sleeve with the tubed end into the Punch/Trial Cage located in situ.

Using a power tool, introduce the K-Wire for Stemless Preparation through the Sleeve into the bone and lock it in the cortical wall. Remove the Sizing Sleeve.

Remove the Punch/Trial Cage using the Impactor for Stemless Cages/Ring Cages. The K-Wire remains in situ and serves as a guide for the implantation of the Stemless Cage.



Figure 5.115

Slide the Impactor for Stemless Cages/Ring Cages through the Impactor Sleeve.



Figure 5.116

Select the Stemless Cage of the same size as the last Punch/Trial Cage used and remove the transportation lock (white plastic cover). Screw the Cage on the assembled Impactor for Stemless Cages/Ring Cages.



Figure 5.117

Axially insert the Cage over the K-Wire into the situs and align the Cage wings according to the prepared implant bed.

At first, the Stemless Cage should not be completely impacted but protrude slightly from the humerus. This facilitates the complete coupling of the taper connection between Head Adapter and Humeral Head. Remove the K-Wire with the Pin Inserter/Extractor.



Figure 5.118

Place the required Head Adapter, reproducing the configuration selected in the trial reduction. For Head Adapters with offset, the final alignment can be determined at this stage. To do so, use the Head Trial Adapter with offset and Humeral Trial Head and perform a trial reduction. Adapt if necessary. In Trial Head Adapters with offset, note the most lateral digit on the Head Trial Adapter.

NOTE: when performing a trial reduction at this stage, consider the Stemless Cage is not yet completely seated which might influence the soft tissue tension.



Figure 5.119

Remove Trial Head and Head Trial Adapter. Place the required final Head Adapter, reproducing the configuration selected in the trial reduction. To do so, align the same digit as the digit determined with the trial prosthesis laterally.



Figure 5.120

Insert the Fixation Screw into the Head Adapter (supplied with the Head Adapter).

Connect the Torx 25 Screwdriverbit to the 3 Nm Torque Wrench and slide it through the Counter Sleeve with the small Sleeve pin at the lower end.



Figure 5.121

Introduce the prepared Screwdriver into the Adapter Fixation Screw and position the Sleeve pin in the small hole in the Head Adapter.



Figure 5.122

Tighten the Screw by turning the Screwdriver clockwise while holding the Sleeve firmly in place with your other hand. The required torque of 3 Nm is reached when a clicking noise can be heard.



Figure 5.123

Place the Humeral Head with the required diameter and height on the Head Adapter. Impact the Humeral Head with the concave Impactor for Humeral Heads. The entire prosthesis is carefully impacted into the humerus until the underside of the Head Adapter rests on the bone surface. Check the Head fixation manually.



Figure 5.124



Figure 5.125

Perform reduction and final check.

If adjustments are necessary, both Humeral Head and Head Adapter can be removed.

For further information on component removal refer to chapter 8.

5.5.2 Stemless Ring Cage Implantation

NOTE: Alternatively to assembling the component in situ as described here, the component can be completely assembled on the sterile table and impacted as a whole afterwards. In this case, follow the workflow described here correspondingly.

Introduce the Sizing Sleeve with the tubed end into the Punch/Trial Cage for Stemless Ring Cage located in situ.

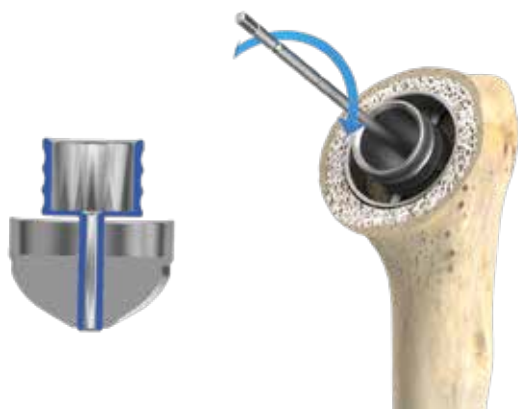

Figure 5.126

Using a power tool, introduce the K-Wire for Stemless Preparation through the Sleeve into the bone and lock it in the cortical wall. Remove the Sizing Sleeve.

Remove the Punch/Trial Cage for Stemless Cage using the Impactor for Stemless Cages/Ring Cages. The K-Wire remains in situ and serves as a guide for the implantation of the Stemless Ring Cage.



Figure 5.127

Select the Stemless Ring Cage of the same size as the last Punch/Trial Cage for Stemless Ring Cage used and screw it on the Impactor for Stemless Cages/Ring Cages.



Figure 5.128

Axially insert the Cage over the K-Wire into the situs and align the Cage wings according to the prepared implant bed. A laser mark inside the Stemless Ring Cage indicates the position of the 4 backside wings.

At first, the Stemless Ring Cage should not be completely impacted but protrude slightly from the humerus. This facilitates the complete coupling of the taper connection between Stemless Ring Cage Head Adapter and Humeral Head. Remove the K-Wire with the Pin Inserter/Extractor.



Figure 5.129

Fit the Stemless Ring Cage Head Adapter into the Cage. In case an Adapter with offset is used, reproduce its position determined and marked in the trial reduction.



Figure 5.130

Place the Humeral Head with the required diameter and height on the Adapter as determined in the trial reduction.

Impact the Humeral Head with the concave Impactor for Humeral Heads. The entire prosthesis is carefully impacted into the humerus until the underside of the Humeral Head rests on the bone surface. Check the Head fixation manually.



Figure 5.131

Perform reduction and final check.

If adjustments are necessary, the Humeral Head and Stemless Ring Cage Head Adapter can be removed. For further information on component removal, refer to chapter 8.

5.5.3 Humeral Standard and Short Stem Implantation

5.5.3.1 Cementless Humeral Standard and Short Stem Implantation

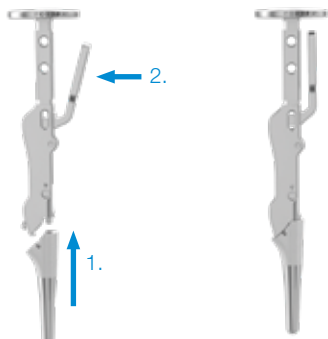

Figure 5.132

NOTE: For cementless implantation, the Humeral Standard or Short Stem of the same size as the last Compressor is used. Compressors and Stems with the same size designation have identical dimensions (Compressors have + 5 mm length).

Remove the transportation lock (white plastic cover) from the selected Humeral Stem.
Connect the Humeral Stem to the Handle.



Figure 5.133

Impact the Humeral Stem taking into account the desired retroversion. For this purpose, the Alignment Rod is screwed into the appropriate hole in the Handle impactation plate rim. Make sure to select the correct set of holes for left and right side treatment.



Figure 5.134

Alternatively, place the Alignment Rod Connector on the Handle and insert the Alignment Rod in the appropriate hole. Make sure to select the correct position of the Alignment Rod Connector for left and right side treatment.

At first, the Humeral Stem should not be completely impacted but protrude slightly from the humerus. This facilitates the complete coupling of the taper connection between Head Adapter and Humeral Head.



Figure 5.135

Place the required Head Adapter, reproducing the configuration selected in the trial reduction. For Head Adapters with offset, the same digit as the digit determined with the trial prosthesis must be aligned laterally.



Figure 5.136

Insert the Fixation Screw into the Head Adapter (supplied with the Head Adapter).



Figure 5.137

Connect the Torx 25 Screwdriverbit to the 3 Nm Torque Wrench and slide it through the Counter Sleeve with the small Sleeve pin at the lower end.



Figure 5.138

Introduce the prepared Screwdriver into the Adapter Fixation Screw and position the Sleeve pin in the small hole in the Head Adapter.



Figure 5.139

Tighten the Screw by turning the Screwdriver clockwise while holding the Sleeve firmly in place with your other hand. The required torque of 3 Nm is reached when a clicking noise can be heard.



Figure 5.140

Place the Humeral Head with the required diameter and height on the Head Adapter. Impact the Humeral Head with the concave Impactor for Humeral Heads. The entire prosthesis is carefully impacted into the humerus until the underside of the Head Adapter rests on the bone surface. Check the Head fixation manually.



Figure 5.141

Perform reduction and final check. If adjustments are necessary, both Humeral Head and Head Adapter can be removed. For further information on component removal, refer to chapter 8

5.5.3.2 Cemented Humeral Standard Stem Implantation

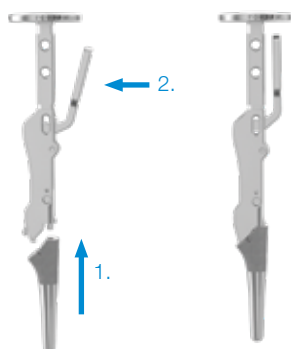

Figure 5.142

NOTE: For cemented implantation, select the Humeral Standard Stem one or two sizes smaller than the last Compressor used. When selecting the Humeral Stem one size smaller than the last Compressor, a cement mantle thickness of approx. 0.5 mm is achieved.

NOTE: Alternatively to assembling the component in situ as described here, it is recommended to completely assemble the humeral component on the sterile table and insert it as a whole afterwards in axial alignment. In this case, follow the workflow described here correspondingly.

The use of high viscosity cement is recommended for cementation.

Remove the transportation lock (white plastic cover) from the selected Humeral Stem. Connect the Humeral Stem to the Handle.



Figure 5.143

Clean the bone using jet or pulse lavage and apply the cement.

Insert the Humeral Stem into the soft cement taking into account the desired retroversion. For this purpose, the Alignment Rod is screwed into the appropriate hole in the Handle impactation plate rim. Make sure to select the correct set of holes for left and right side treatment.



Figure 5.144

Alternatively, place the Alignment Rod Connector on the Handle and insert the Alignment Rod in the appropriate hole. Make sure to select the correct position of the Alignment Rod Connector for left and right side treatment.



Figure 5.145

Manually press down the Stem into the soft cement until it is positioned at the same level as the last Compressor used. Remove excessive bone cement. With the Handle, the prosthesis is held in position until the cement is cured.

Align and fix both Head Adapter and Humeral Head as described in 5.5.3.1.

5.5.4 Proximal Body, Modular Stem/Modular Revision Stem and Humeral Fracture Stem Implantation (FX)

5.5.4.1 Cementless Proximal Body, Modular Stem/Modular Revision Stem and Humeral Fracture Stem Implantation (FX)

NOTE: In cementless application, Modular Stem/Modular Revision Stem and Proximal Body are assembled in situ.

NOTE: Humeral Fracture Stems have a monoblock design and therefore don't need to be assembled. In order to implant Humeral Fracture Stems, connect the required Stem to the Handle for Compressors and Proximal Bodies and follow the workflow described in this chapter correspondingly.



Figure 5.146

Connect the required Modular Stem/Modular Revision Stem determined with the trial reduction to the Handle for Modular Stems (threaded connection).

Attach the Template for Proximal Bodies to the Handle. Introduce the Modular Stem/Modular Revision Stem into the humerus and impact until good stability is achieved.

Using the Template for Proximal Bodies, check the position of the final Modular Stem/final Modular Revision Stem.

NOTE: Another trial reduction can be performed at this stage (suggested in case the final Stem position differs from the Trial Stem position). Proximal Trial Bodies can be connected to the final Modular Stem/final Modular Revision Stem in situ to determine the appropriate final Proximal Body height.

Remove the Handle and Template.
Remove the transportation lock (white plastic cover) from the final Proximal Body determined with the trial reduction.



Figure 5.147

NOTE: LINK Embrace Proximal Bodies and Modular Stems/Modular Revision Stems are fixed to each other by a taper connection. A pre-assembled locking screw inside the Proximal Body is used to tighten the coupling. This is done by means of a Torx 25 Screwdriverbit and a 5 Nm Torque Wrench. When pushing the Screwdriverbit into the locking screw, make sure the line mark for the respective height of the Proximal Body on the Screwdriverbit is at the level of the Handle impaction plate. This indicates that the Screwdriverbit is fully inserted into the locking screw head.



Figure 5.148

Connect the Proximal Body to the Handle for Compressors and Proximal Bodies and place it on the Modular Stem/Modular Revision Stem in situ. Do not impact.
Connect the Torx 25 Screwdriverbit to the 5 Nm Torque Wrench and slide it through the Handle into the head of the preassembled locking screw within the Proximal Body.

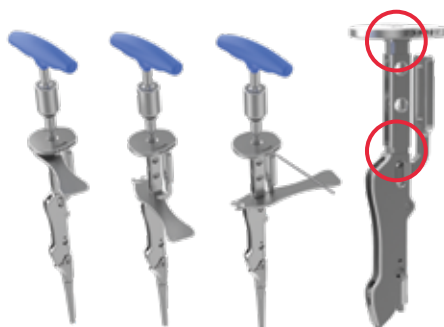

Figure 5.149

Slightly turn the locking screw just until the threaded connection of screw and Stem engages, leaving the Proximal Body freely rotatable on the Modular Stem. Align the required retroversion using the Alignment Rod screwed into the appropriate hole in the Handle impaction plate.

Alternatively, align the retroversion with the Alignment Rod screwed into the appropriate hole of the Alignment Rod Connector which is connected to the Handle.

Slide the Separator Wrench with its cut outs onto one of the recesses at the Handle. For convenient use, the Separator Wrench can be attached in several positions.



Figure 5.150

Tighten the locking screw within the Proximal Body using the 5 Nm Torque Wrench and the Torx 25 Screwdriverbit with your other hand firmly holding the Separator Wrench. The required torque is reached when a clicking noise can be heard. Remove Screwdriver and Handle.

Optionally, you may now perform another trial reduction with a Head Trial Adapter and Humeral Trial Head. Adapt the configuration if necessary. Place the required Head Adapter, reproducing the configuration selected in the trial reduction. For Head Adapters with offset, the same digit as the digit determined with the trial prosthesis must be aligned laterally.



Figure 5.151

NOTE: Neutral Head Adapters (offset 0 mm) are provided with and without circular holes to allow for tuberosities reattachment depending on surgeon's preference.



Figure 5.152

Insert the Fixation Screw into the Head Adapter (supplied with the Head Adapter).



Figure 5.153

Connect the Torx 25 Screwdriverbit to the 3 Nm Torque Wrench and slide it through the Counter Sleeve with the small Sleeve pin at the lower end.



Figure 5.154

Introduce the prepared Screwdriver into the Adapter Fixation Screw and position the Sleeve pin in the small hole in the Head Adapter.



Figure 5.155

Tighten the Screw by turning the Screwdriver clockwise while holding the Sleeve firmly in place with your other hand. The required torque of 3 Nm is reached when a clicking noise can be heard.

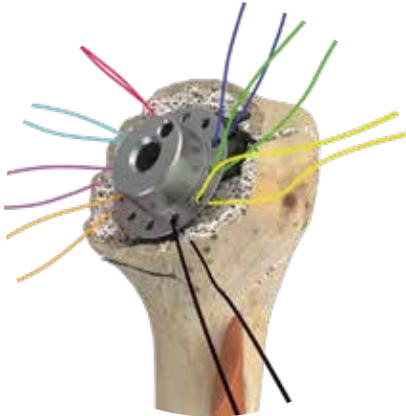

Figure 5.156

If required, attach sutures for tuberosities reattachment to the (neutral) Head Adapter at this stage.



Figure 5.157

If required, sutures can also be attached using the m-l and a-p holes of the Proximal Body.



Figure 5.158

Place the final Humeral Head with the required diameter and height onto the Head Adapter. Impact lightly using the concave Impactor for Humeral Heads and check the Head fixation manually.



Figure 5.159

Reduce the joint. If adjustments are necessary, both Humeral Head and Head Adapter can be removed with the Separator Wrench. When removing the Head Adapter, remove the Fixation Screw first. For further information on component removal, refer to chapter 8.

Go on with chapter 5.5.4.3.

5.5.4.2 Cemented Proximal Body, Modular Stem/Modular Revision Stem and Humeral Fracture Stem Implantation (FX)

NOTE: For cemented implantation, select the Modular Stem/Modular Revision Stem or the Humeral Fracture Stem (monoblock) one or two sizes smaller than the last Trial Stem or Humeral Fracture Trial Stem used. Modular Trial Stems/Fracture Trial Stems and final Modular Stems/final Humeral Fracture Stems with the same size designation have identical intramedullar stem dimensions. When selecting the final component one size smaller than the corresponding trial component, a cement mantle thickness of approx. 0.5 mm is achieved.

NOTE: In cemented application, Modular Stem/ Modular Revision Stem and Proximal Body are assembled on the sterile table. It is recommended to completely assemble the humeral component on the sterile table and insert it as a whole afterwards in axial alignment.

NOTE: Humeral Fracture Stems have a monoblock design and therefore don't need to be assembled. In order to implant Humeral Fracture Stems, connect the required Stem to the Handle for Compressors and Proximal Bodies and follow the workflow described in this chapter correspondingly.

The use of high viscosity cement is recommended for cementation.

Remove the transportation lock (white plastic cover) from the final Proximal Body determined with the trial reduction.

Connect the Proximal Body to the Handle for Compressors and Proximal Bodies.
Connect the Proximal Body to the required Modular Stem/Modular Revision Stem and tighten the locking screw within the Proximal Body as described in chapter 5.5.4.1.
Connect the Template for Proximal Bodies to the Handle.

Clean the bone using jet or pulse lavage and apply the cement.

Insert the assembled humeral component into the soft cement taking into account the desired retroversion.

For this purpose, the Alignment Rod is screwed into the appropriate hole in the Handle impaction plate rim. Make sure to select the correct set of holes for left and right side treatment.



Figure 5.160



Figure 5.161

Alternatively, place the Alignment Rod Connector on the Handle and insert the Alignment Rod in the appropriate hole. Make sure to select the correct position of the Alignment Rod Connector for left and right side treatment.



Figure 5.162

Manually press down the humeral component into the soft cement until the Template for Proximal Bodies indicates the previously defined component level. Remove excessive bone cement. With the Handle, the prosthesis is held in position until the cement is cured.

Remove the Handle. Align and fix both Head Adapter and Humeral Head as described in 5.5.4.1.

Go on with chapter 5.5.4.3.

5.5.4.3 Tuberosity Refixation

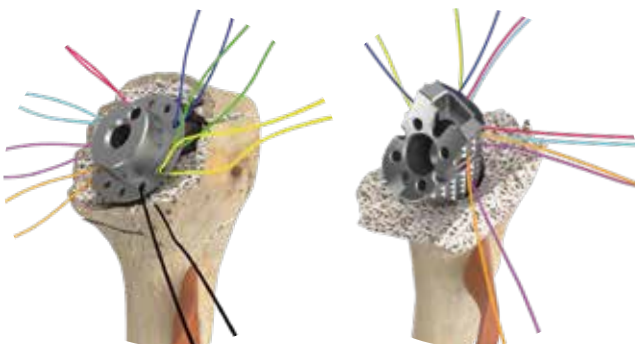

Figure 5.163

For the refixation of the tuberosities with surgical sutures, the circular drill holes of the neutral Head Adapter (0 mm offset) can be used.

All Proximal Bodies have holes for tuberosity refixation using suture material on the anterior and posterior side in m-l orientation, additionally lateral in a-p orientation. Medially, the suture material is positioned and held in recesses.

Tuberosity refixation is carried out according to the requirements defined by the surgeon.

6. Reverse Total Shoulder Arthroplasty

This chapter describes the surgical technique for reverse Total Shoulder Arthroplasty using

- Stemless Ring Cages
- Humeral Short Stems
- Humeral Standard Stems
- Modular Stems with Proximal Bodies
- Modular Revision Stems with Proximal Bodies
- Humeral Fracture Stems
- Reverse Trays, Humeral Extenders and Reverse Inserts
- Reverse Glenoid Baseplates and Glenospheres

The LINK Embrace Shoulder System offers the above mentioned components for both primary and revision surgery applying reverse joint configuration. Furthermore, the system allows for conversion of previously implanted anatomic configurations to reverse joint configurations without removal of well fixed components.

A multi option Reverse Glenoid Baseplate, available with standard and long peg for revisions, hosts the Glenospheres which can be selected from a wide range of different options. In case of conversion of a primarily implanted, well integrated Convertible Glenoid into reverse configuration, the anatomic PE Glenoid Insert can be retrieved and replaced by a Glenosphere. When converting a humeral component from anatomic to reverse configuration, only the Head Adapter and the Humeral Head need to be replaced by reverse components. Several options, e.g. inclined Reverse Trays and Inserts, allow for individual adaption of the joint kinematics to the patient requirements. For further information on component conversion, refer to chapter 7.

NOTE: In case a reverse, stemless prostheses configuration is intended, the use of a Stemless Ring Cage is mandatory.

6.1 Humeral Head Resection

6.1.1 Intramedullary Alignment



Expose and mobilize the humeral head and luxate it from the glenoid.

Figure 6.1



Figure 6.2

Open the medullary canal with a suitable instrument in line with the humeral axis.

NOTE: In case the implantation of a Stemless Ring Cage is intended, it is recommended to perform the head resection using the extramedullary alignment method (refer to 6.1.2).

Using the T-Handle, insert the Starter Awl into the medullary canal until the depth stop is reached. Make sure that the blue Depth Stop Disk rests in the Starter Awl shaft recess.



Figure 6.3

Prepare the Resection Guide depending on the surgical approach, i.e. selection of the Resection Block for delto-pectoral or for lateral approach.

NOTE: The LINK Embrace Instrument Set supports different surgical approaches. In the surgical technique described here, the delto-pectoral approach is used.

For lateral techniques use the Resection Block for lateral approaches and follow the workflow correspondingly.



Figure 6.4

Slide the Resection Guide down on the Starter Awl placed in the medullary canal by applying light pressure on the instrument spring clamp.



Figure 6.5

Connect the desired Resection Block and the Resection Guide Connector with the laser marks on both Connector Bar and Resection Block in line. The Resection Block is fixed to the Connector Bar by means of a magnetic connection.



Figure 6.6

Considering the side to be treated, insert the Resection Guide Connector into the fork of the Resection Guide. A slight initial resistance prevents the instrument from slipping out of the fork.



Figure 6.7

According to the desired retroversion, screw the Alignment Rod into the corresponding hole (0°, 10°, 20°, 30°) in the Alignment Rod Connector. Make sure to select the correct set of holes for treatment of the left or right side respectively, corresponding to the laser marking on the Alignment Rod Connector.

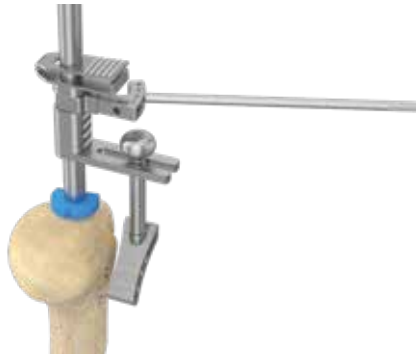

Figure 6.8

Place the Alignment Rod Connector with the Alignment Rod in the required orientation on the Resection Guide receptacle.



Figure 6.9

Set the desired retroversion by axially rotating the Resection Guide on the Starter Awl, adjusting the Alignment Rod parallel to the forearm which is held flexed at appr. 90°.

Adjust the Resection Guide to the desired resection level (to change the instrument level, press the instrument spring). The spring locks the instrument when released.

Finally determine the resection level with respect to the anatomical neck of the humeral head.

Push the Resection Block together with the Resection Guide Connector so that it slides within the fork until it gets into contact with the bone.

Fix the Resection Block with at least two Fixation Pins (3.0 mm) using the Universal Pin Inserter.

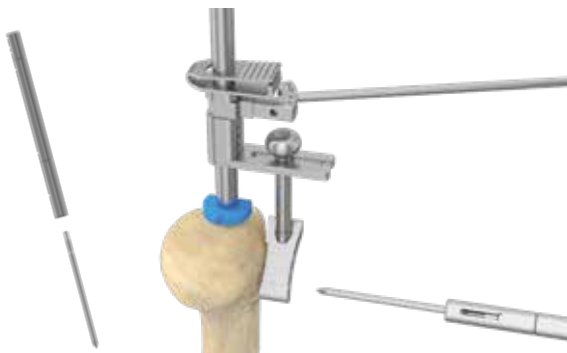

Figure 6.10

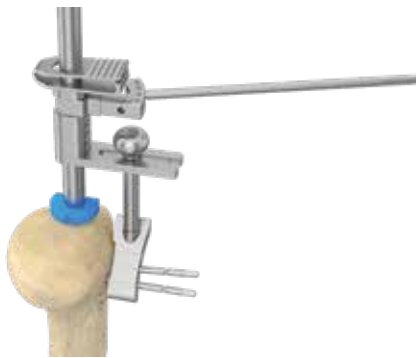

Figure 6.11

Outer pins run parallel and allow for sliding the Block on the pins. The central hole is oblique and locks the Resection Block position on the bone. The orientation of the pinholes is marked accordingly on the Block. Take note that the most lateral pin might interfere with the intramedullary Starter Awl.

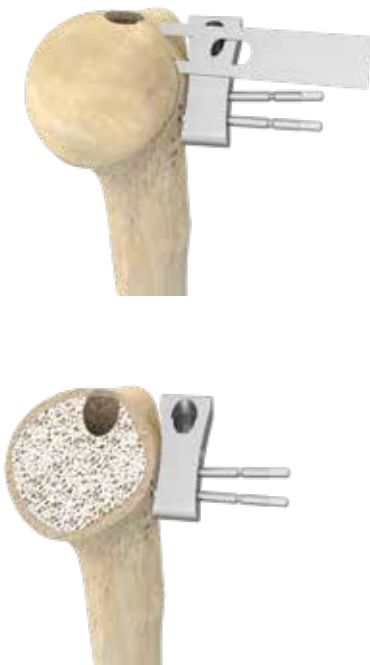

Figure 6.12

After final check of resection level and retroversion, the humeral head is resected with an oscillating saw blade on top of the Resection Block at 135° (defined by the instrument).

For this purpose, all instruments except the fixed Resection Block can be removed by pulling them upwards. To do so, press the spring on the Resection Guide, release the magnet connection between Resection Block and Resection Guide Connector and slide the Resection Guide upwards over the Starter Awl. Then remove the Starter Awl using the T-Handle.

For more stability, e.g. in case of poor fixation, the Resection Guide can also be left in place. When sawing, make sure to avoid any instrument interference.



Figure 6.13

Remove all instruments. Pins can be removed with the Pin Inserter/Extractor.

6.1.2 Extramedullary Alignment



Figure 6.14

Alternatively to intramedullary alignment and especially when Stemless Ring Cages are planned to be implanted, use the Resection Guide for extramedullary alignment.

The extramedullary Resection Guide has a built-in angle of 135°.



Figure 6.15

According to the desired retroversion, screw the threaded end of the Alignment Rod into the corresponding hole (0°, 10°, 20°, 30°) on the vertical Resection Guide bar.

The Guide has two opposing sets of holes for left and right application.



Figure 6.16

Align the rod-shaped neck of the instrument along the humeral shaft axis. A second Alignment Rod may be screwed into the hole at the distal Guide end, prolonging the instrument axis for easier positioning.



Figure 6.17

Set the desired retroversion by internal or external rotation of the Guide, adjusting the Alignment Rod parallel to the forearm which is held flexed at approx. 90°.



Figure 6.18

Determine the final resection level with respect to the anatomical neck of the humeral head. Fix the Resection Guide with at least two Fixation Pins (3.0 mm) using the Universal Pin Inserter. Outer pins run parallel and allow for sliding the Block on the pins. The central hole is oblique and locks the Resection Block position on the bone. The orientation of the pinholes is marked accordingly on the Guide.

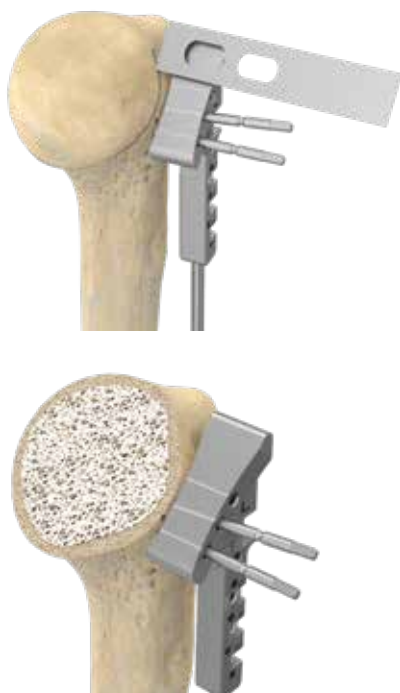

Figure 6.19

After final check of level and retroversion, resect the humeral head with an oscillating saw blade on top of the Resection Guide.

6.1.2.1 Alternative Retroversion Determination

The LINK Embrace Instrument Set supports an alternative way to determine the retroversion, using the Alignment Rod and the Alignment Rod Connector.



Figure 6.20

According to the desired retroversion, place the Alignment Rod into the corresponding hole (0°, 10°, 20°, 30°) in the Alignment Rod Connector. Make sure to select the correct set of holes for treatment of the left or right side respectively.

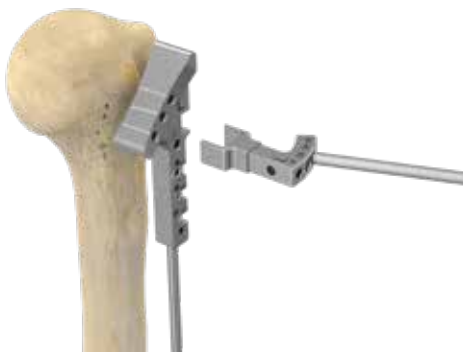

Figure 6.21

Place the Alignment Rod Connector with the Alignment Rod in the required orientation on the Resection Guide receptacle.

Go on as described in 6.1.2

6.2 Humerus Preparation

6.2.1 Stemless Ring Cage Preparation

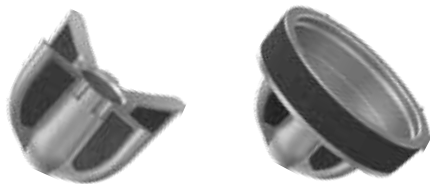

Figure 6.22

NOTE: Stemless Ring Cages can be used for primary reverse treatment. These Cages are designed to directly host the Reverse Inserts. Furthermore, they allow for anatomic reconstruction when combined with specific adapters. For further information on Stemless Ring Cages in anatomic configuration refer to chapters 4 and 5.

All LINK Embrace Stemless Ring Cages have a TrabecuLink surface, aiming at fast and stable component integration into the surrounding bone.

Resect the humeral head using the Extramedullary Resection Guide, taking into account the desired retroversion and the desired resection level as described in 6.1.2.

Figure 6.23



Determine the size of the Cage using the Sizer Disks. Place the Sizer Disk on the resection surface and check for best circumferential fit.

Figure 6.24



NOTE: Sizer Disks are available in sizes 30, 32, 34, 36, 38 and 40 mm.
Stemless Ring Cages are available in sizes 34, 36, 38, 40.
Sizer Disks have exactly the same diameter as the corresponding implant.

NOTE: Stemless Ring Cages are designed to be implanted in cancellous bone. It is recommended to select the biggest component possible in each individual case. When positioning the Cage, make sure the Cage wings are not directly oriented towards the biceps tendon groove.

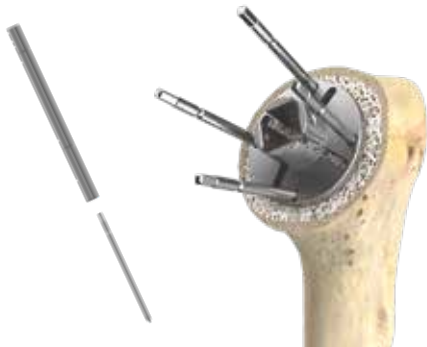

Figure 6.25

Position the appropriate Sizer Disk with optimal fit on the resection surface and slightly impact to fix it with the back pins in the bone.

Lock the Sizer Disk with at least two additional, opposite Fixation Pins through the pin holes at the Sizer Disk edge, using the Universal Pin Inserter.

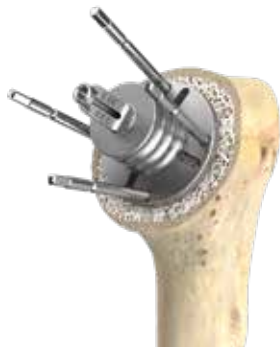

Figure 6.26

Place the Sizer Sleeve for K-Wires on the Sizer Disk.



Figure 6.27

Push the K-Wire for Stemless Cage preparation (\varnothing 2.7 mm) through the Sizer Sleeve into the bone. Stop advancing the K-Wire upon cortical contact.

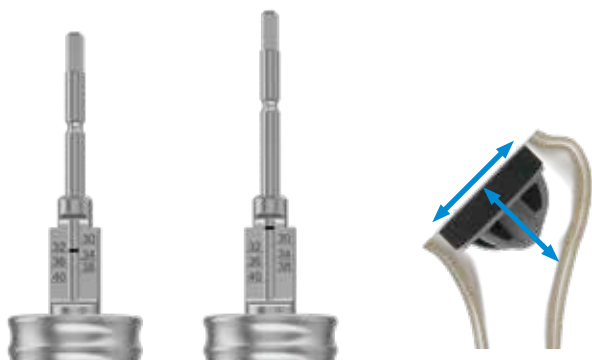

Figure 6.28

Check the laser mark on the K-Wire within the window of the Sizer Sleeve shaft. The mark indicates the biggest possible size of the Stemless Ring Cage. In case the K-Wire laser mark is at the level or below the size 34 mark (on the window scale, figure, left), the humerus is big enough to host the Stemless Ring Cage of the size indicated. If the K-Wire mark is above the mark for size 34 (figure, middle), the humerus is too small to host a Stemless Ring Cage. In this case, consider to use a stemmed component.



Figure 6.29

Remove the K-Wire with the Pin Inserter/Extractor. Replace the Sizer Sleeve for K-Wires with the Center Sleeve for the Central Peg Punch.



Figure 6.30

Drive the Central Peg Punch through the Sizer Disk and impact until the depth stop is reached.



Figure 6.31

Remove the Central Peg Punch and the Center Sleeve. Screw the Punch/Trial Cage for Stemless Cages of the same size as the Sizer Disk used onto the Impactor for Stemless Cages/Ring Cages. Make sure the Depth Stop Disk rests in the Impactor shaft recess.

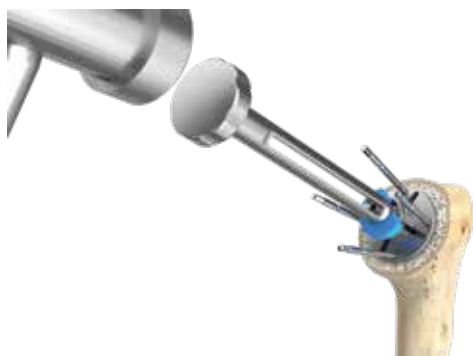

Drive the Punch/Trial Cage for Stemless Cages through the Sizer Disk until the depth stop is reached.

Figure 6.32

6.2.1.1 Stemless Ring Cage Preparation (continued)



Figure 6.33

Remove the Punch/Trial Cage using the Impactor for Stemless Cages/Stemless Ring Cages. Remove the Fixation Pins and the Sizer Disk using the Pin Inserter/Extractor.



Figure 6.34

Screw the Punch/Trial Cage for Stemless Ring Cage of the same size as the Sizer Disk used onto the Impactor for Stemless Cages/Stemless Ring Cages.



Figure 6.35

Align the Punch/Trial Cage with the prepared implant bed and impact until the upper surface of the Punch ring is flush with the resection plane.



Figure 6.36

Connect the Reamer for Stemless Ring Cage preparation to the T-Handle in order to remove the cancellous bone within the Punch ring. Alternatively, compact the bone with an appropriate instrument.



Figure 6.37

Ream and remove the bone until the depth stop is reached.

Leave the Punch in situ. This serves as a Trial Cage and is used for trial reduction in the next step. At this stage, you may use the bone removed with the Reamer and press it into the cancellous bone cavities for interdigitation.

Go on with chapter 6.3.

6.2.2 Humeral Standard and Short Stem Preparation

NOTE: The LINK Embrace System offers Humeral Stems in two different lengths: Humeral Standard Stems with 100 mm and Humeral Short Stems with 75 mm length. For both ranges dedicated humeral Compressors are used. Compressors are 5 mm longer than the corresponding Stems.



Figure 6.38

Medullary canal preparation is started with the smallest Compressor (size 12) in the required length (75 mm or 100 mm).

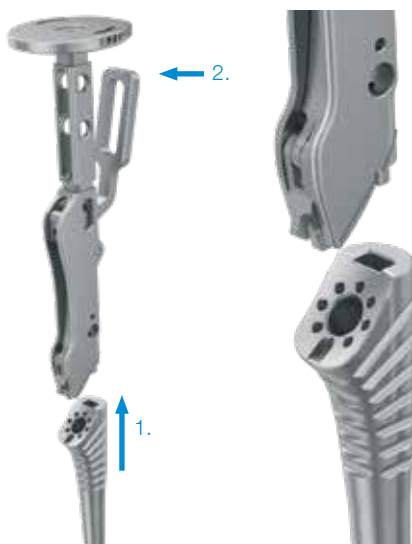

Figure 6.39

Connect the Compressor to the Handle for Compressors and Proximal Bodies by opening the Handle lever and inserting the nose piece at the end of the Handle into the Compressor's groove located laterally. Close the Handle lever, locking the Compressor firmly to the Handle.



Figure 6.40

According to the desired retroversion, screw the threaded end of the Alignment Rod into the corresponding hole (0°, 10°, 20°, 30°) in the rim of the Handle impaction plate. Make sure to select the correct set of holes for treatment of the left or right side respectively.



Figure 6.41

Alternatively, the Alignment Rod may be used together with the Alignment Rod Connector to determine the desired retroversion as described in 6.1.1.

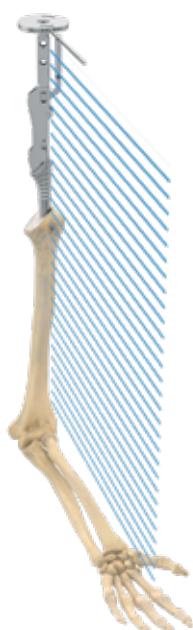

Figure 6.42

Insert the Handle with the Compressor into the humeral shaft. Set the desired retroversion by axially rotating the Handle, adjusting the Alignment Rod parallel to the forearm which is held flexed at approx. 90°.



Figure 6.43

Gradually prepare the humeral canal until the size determined in the preoperative planning is reached. The Compressor has to be stable and the line mark on the Handle has to be flush with the resection surface (red circle). The Compressor is now slightly recessed within the bone.



Figure 6.44

Remove the Handle, leaving the last Compressor in situ.

Connect the Finishing Reamer with the T-Handle (Hudson fitting).



Figure 6.45

Ream the humeral resection surface with the Finishing Reamer and create a concave front face. To do so, insert the blue Reamer guide tip into the female taper of the humeral Compressor and align axially.



Figure 6.46

Ream manually until the depth stop is reached. Remove the Reamer.



Figure 6.47

Depending on the posterior head offset, choose the appropriate Humerus Protection Plate from two options: neutral or 6 mm offset version.

Place the selected Humerus Protection Plate on the resection surface with its peg in the central hole of the humeral component.

Depending on the preferred workflow, glenoid preparation can be performed immediately after humeral head resection. The Humerus Protection Plates can also be placed directly onto the bone and be fixed with the aid of the backside pins.

Go on with chapter 6.3.

6.2.3 Proximal Body, Modular Stem/Modular Revision Stem and Humeral Fracture Stem Preparation (FX)

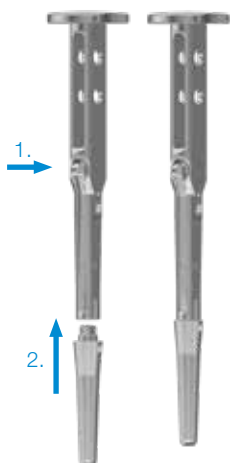

Figure 6.48

Determine the appropriate diameter and length of the Modular Stem/Modular Revision Stem using the Modular Trial Stems, which are coupled to the Handle for Modular Trial Stems. To attach the Modular Trial Stem to the Handle, press the Handle lever.

Place the Trial Stem on the Handle and release the lever. For disassembly, press the lever again and remove the Trial Stem.



Figure 6.49

The selected Modular Trial Stem is carefully driven into the bone until good stability is achieved.

NOTE: To adjust the prosthesis height, the LINK Embrace Shoulder System offers Proximal Bodies and Trials in three different heights: -5, 0 and +5, each in three sizes: S, M and L. A Template for Proximal Bodies is used to determine the required Proximal Body height.

NOTE: The Template is used for both left and right side. To adapt the Template to the appropriate side, slide the Template plate on the Template bar into the circumferential recess. Rotate the Template plate by 90° and detach it from the Template bar.

Depending on the side to be treated, flip the plate so that the front marking reads “left” or “right”. Reattach the plate to the bar by sliding it over the flattened bar end into the recess. Rotate the plate by 90° and slide it on the Template bar.

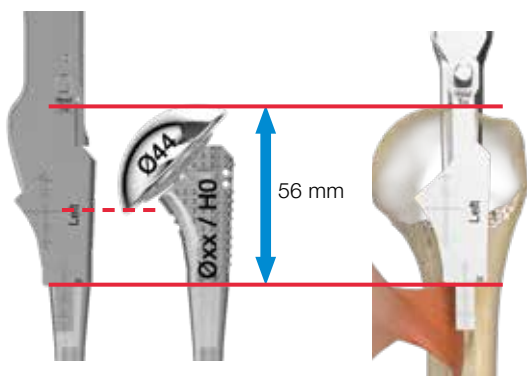

Figure 6.50

NOTE: To determine the required height of the Proximal Body, the Template for Proximal Bodies references to the proximal insertion of the Pectoralis Major m., which is approximately 56 mm below the highest point of the humeral head.

The Template contour corresponds to the Proximal Body of height "0" and size "S".

The upper line mark on the Template indicates the height of a Humeral Head with a diameter of 44 mm and a height of 16 mm. The lower end of the scale is 56 mm below the upper line mark. The position of the scale end relative to the insertion can be used to determine if a different Modular Stem (length and size) and/or a higher Proximal Body has to be used.



Figure 6.51

Check the correct height level of the Stem considering the required height of the Proximal Body.

To do so, attach the Template for Proximal Bodies to the Handle for Modular Trial Stems by inserting the Template bar and pin into the corresponding grooves located on the Handle.

A magnetic connection fixes the Template bar to the Handle.



Figure 6.52

Connect the Handle to the Trial Stem in situ and refer to the insertion of Pectoralis Major m. as described. In case the required level can not be achieved with the different Proximal Body heights available, adapt the level of the Modular Trial Stem. To do so, it may be necessary to select a Modular Trial Stem of a different size and/or length.



Figure 6.53

Once an appropriate Trial Stem has been inserted, remove the Handle for Modular Trial Stems.

Connect the Proximal Trial Body with height "0" and size "M" to the Handle for Compressors and Proximal Bodies.

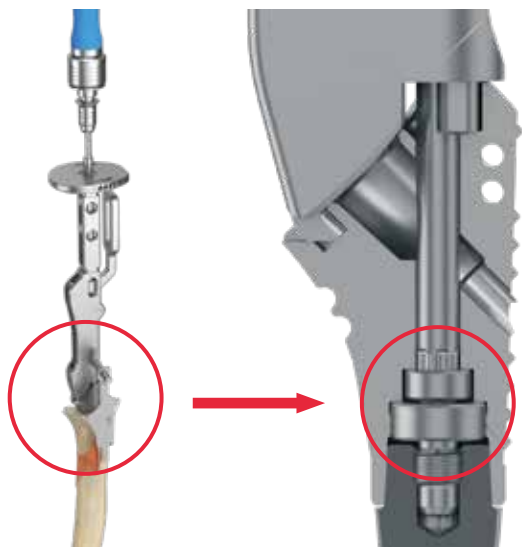

Figure 6.54

Place the Proximal Trial Body on the Modular Trial Stem located in situ.
 Connect the Torx 25 Screwdriverbit to the Ratchet and push it through the cannulated Handle into the Proximal Trial Body. Make sure the Screwdriverbit fully engages into the head of the preassembled locking screw within the trial component.



Figure 6.55

Tighten the locking screw slightly with the Ratchet to create the connection between Modular Trial Stem and Proximal Trial Body.
 According to the desired retroversion, screw the threaded end of the Alignment Rod into the corresponding hole (0°, 10°, 20°, 30°) in the rim of the Handle impactation plate. Make sure to select the correct set of holes for treatment of the left or right side respectively.

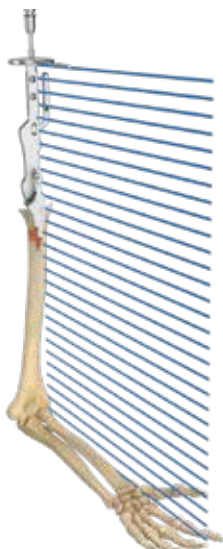

Figure 6.56

Alternatively, use the Alignment Rod together with the Alignment Rod Connector to determine the desired retroversion as described in 6.1.1.
 Set the desired retroversion by axially rotating the Handle, adjusting the Alignment Rod parallel to the forearm which is held flexed at approx. 90°. To do so, slightly loosen the locking screw within the Proximal Trial Body.

Once the desired retroversion has been adjusted, tighten the screw and remove both Screwdriver and Handle.

Go on with chapter 6.3.

6.3 Reverse Glenoid Preparation

NOTE: Prior to glenoid preparation, visually check the scapula bone stock for appropriate integrity. In case the bone stock is not sufficient, measures have to be considered to allow for alternative appropriate component fixation.

6.3.1 Glenoid Positioning

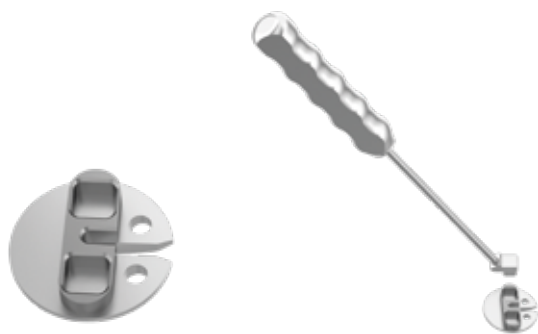

Figure 6.57

Relocate the humerus posterior-caudally with the help of a double fork retractor or a Fukuda retractor. Excise labrum and osteophytes to expose the glenoid.

Connect the K-Wire Positioner for Reverse Base-plate to the Handle for Glenoid Sizers and Drill Templates (magnetic connection).



Figure 6.58

Place the K-Wire Positioner according to your preferences. Usually, the Positioner is placed as inferiorly as possible, avoiding any overhang of the Positioner with respect to the bony glenoid rim. Place the K-Wire for Glenoid Preparation (Ø 2.5 mm) with the drilling machine through the central hole of the Positioner in the desired direction.



Figure 6.59

After removal of the Positioner, visually check the correct position of the K-Wire and reposition it if necessary. To do so, use the Repositioner for K-Wires.

The Repositioner for K-Wires allows for parallel shifting the K-Wire in 3, 4 and 7 mm distance. Depending on the required offset, slide the Repositioner over the K-Wire through the corresponding hole down to the glenoid and align the offset.



Figure 6.60

Insert a second K-Wire through the specified lumen.

After removal of the Repositioner, visually check the correct position of the K-Wire.
Remove the initially positioned K-Wire with the Pin Inserter/Extractor.



Figure 6.61

NOTE: Alternatively, the K-Wire may be placed through the Guide Handle for K-Wire, ensuring perpendicular alignment of the K-Wire with respect to the K-Wire Positioner.



Figure 6.62

To do so, place the Guide Handle for K-Wire on the Positioner so that the two Guide noses click into the grooves of the Positioner (magnetic connection).



Figure 6.63

Place the instrument on the glenoid according to your preferences. Usually, the Positioner is placed as inferiorly as possible, avoiding any overhang of the Positioner with respect to the bony glenoid rim.
Place a K-Wire through the Guide Handle into the glenoid bone.

6.3.2 Glenoid Reaming



Figure 6.64

Glenoid reaming is carried out with the Glenoid Reamer size S (Ø 28 mm).

NOTE: LINK Embrace Glenoid Reamers have a slotted central hole, allowing for slightly tilting the Reamer on the K-Wire. A cut-out at the outer Reamer ring facilitates passing the surrounding soft tissue and, thus, pushing the Reamer down to the glenoid.

Select the Glenoid Reamer of size small (Ø 28 mm), tilt it and slide over the K-Wire down to the glenoid.

Slide the cannulated Drive Shaft for glenoid preparation (with the Tissue Protection Sleeve installed) over the K-Wire and insert it into the situs. Connect the Drive Shaft to the Glenoid Reamer in situ. To do so, insert the external hexagon of the Drive Shaft into the internal hexagon of the Reamer (magnetic connection).



Figure 6.65

Carefully ream the glenoid. For manual reaming, connect the T-Handle to the Drive Shaft employing the Hudson fitting.



Figure 6.66

NOTE: Take into account the stability of the bone. Avoid applying excessive forces and overreaming of the glenoid. It is recommended to carefully place the reamer onto the glenoid. When using a power tool, have it already rotating before contact.

After reaming, remove the Drive Shaft and Reamer in reverse order, leaving the K-Wire in situ.

6.3.3 Drilling of Central Hole for Reverse Glenoid Baseplates

NOTE: LINK Embrace Reverse Glenoid Baseplates are available with standard peg (15 mm) and long peg (25 mm). Depending on the required peg length, select the appropriate Drill for the central peg hole.



Figure 6.67

Drill the central hole for the central peg of the Reverse Glenoid Baseplate with the Drill for Central Pegs of Reverse Glenoid Baseplate and Metal-Back for Convertible Glenoids over the K-Wire. To do this, attach the corresponding Drill (standard or long) for Central Pegs to the Drive Shaft (hexagon with magnetic connection) and drill until the depth stop is reached.

Remove all instruments.

6.3.4 Reverse Glenoid Baseplate Implantation



Figure 6.68

Slide the threaded Shaft for Impactor into the Impactor. Turn it clockwise to pass the safety thread that prevents the Shaft from slipping out of the Impactor sleeve.

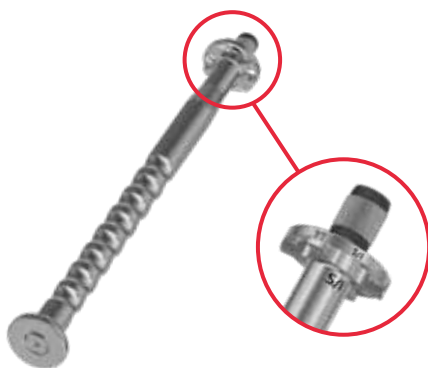

Figure 6.69

Attach the required Reverse Glenoid Baseplate to the Impactor and fix it by turning the inner Shaft clockwise using the Torx 20 Screwdriverbit connected to the Ratchet. When connecting the Reverse Baseplate to the Impactor, align the “S/I” (superior/inferior) laser mark on the Impactor with the “S/I” mark on the Reverse Baseplate rim.



Figure 6.70

With the Reverse Glenoid Baseplate firmly fixed to the Impactor, the instrument is introduced into the situs.

Prior to impaction make sure that the “S/I” mark on the Reverse Glenoid Baseplate rim is oriented superiorly. Usually, the superior hole is directed towards the coracoid base.

With the component aligned in the described way, axially impact the Baseplate until it is fully seated.

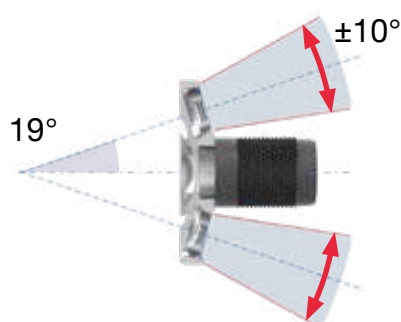

Figure 6.71

NOTE: LINK Embrace Reverse Glenoid Baseplates anchor in the bone using a central pressfit peg and up to four peripheral Bone Screws. If required, a central Bone Screw can be applied through the central peg for additional fixation. Peripheral Screws are available as Ø 6.0 mm cancellous Bone Screws, Ø 4.5 mm cortical Bone Screws and Ø 4.5 mm angle stable cortical Bone Screws.

All peripheral screw holes of the Reverse Glenoid Baseplate can be filled with any of these screw types. It should be noted that the superior and inferior screw holes allow for polyaxial alignment of angle-stable screws, in which the screw angle can be selected within a range of $\pm 10^\circ$ from the neutral position. The neutral position of the superior and inferior holes is designed 19° divergent in relation to the central peg. Likewise, the posterior and anterior screw holes allow for monoaxial alignment of angle-stable screws. The axes of the posterior and anterior screw holes are designed monoaxial and parallel to the central peg.

All peripheral Bone Screws are available in lengths 20, 25, 30, 35, 40, 50 and 60 mm and have a self-tapping tip. They are tightened using the Torx 25 Screwdriverbit connected to the Ratchet.

6.3.4.1 Reverse Glenoid Baseplate: Use of Central Bone Screws

NOTE: If required, LINK Embrace Reverse Glenoid Baseplates can additionally be fixed with a central Bone Screw. For this purpose, cancellous cylinder head Bone Screws with Ø 6.0 mm and lengths of 15, 20, 25 and 30 mm are available.



Figure 6.72

Insert the Drill Guide for central Screws into the Reverse Glenoid Baseplate central hole. The Drill Guide determines the direction of the screw. Drill the screw hole with the Ø 3.2 mm Drill to the desired depth.



Figure 6.73

The required screw length is determined with the Depth Gauge.



Figure 6.74

The cancellous cylinder head Screw of the desired length is inserted with the Torx 25 Screwdriverbit, which is connected to the Ratchet and tightened until it is fully seated.

NOTE: Make sure the Bone Screw is fully seated. Go on tightening the Bone Screw until the laser mark on the Screwdriverbit is level with the Reverse Baseplate surface, indicating the Bone Screw is in the required position.

NOTE: Care must be taken to not overtighten the central Bone Screw as this might impair the fixation of the Screw or damage the bone.

6.3.4.2 Superior and Inferior Bone Screws (angle stable and non angle stable)

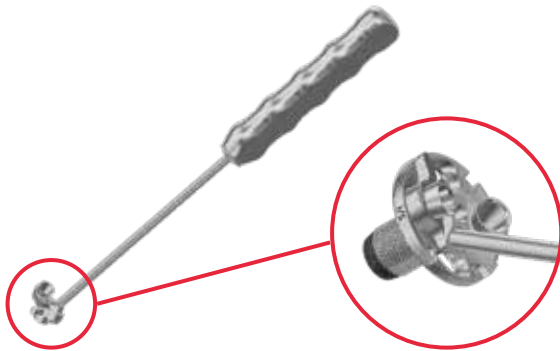

Figure 6.75

Insert the “S/I” polyaxial Drill Guide with its rear peg into the central Baseplate hole, taking care of the proper alignment of the Guide on the Baseplate with the fingershaped Guide peg in the corresponding Baseplate recess.

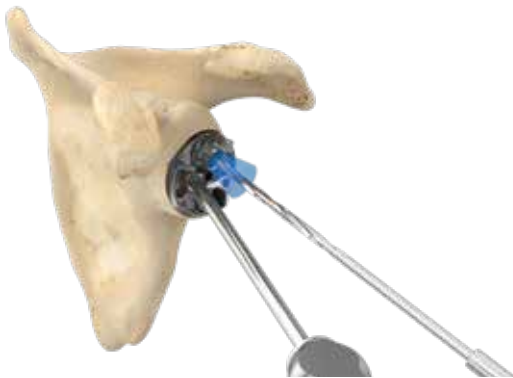

Figure 6.76

The Drill Guide limits the possible angulation range of the drill. Make sure to not exceed this under any circumstances.



Figure 6.77

Select an appropriate angle and drill the screw hole with the Ø 3.2 mm drill to the desired depth. Usually, the superior screw is directed towards the coracoid base. Determine the required screw length with the Depth Gauge.

Select the required screw type from Ø 6.0 mm cancellous Bone Screws, Ø 4.5 mm cortical Bone Screws or Ø 4.5 mm angle-stable cortical Bone Screws.

NOTE: in case the use of both angle-stable and standard (non angle-stable) Bone Screws is intended, it is recommended to apply the standard screws first in order to achieve compression between Baseplate and glenoid bone.

Insert the selected Bone Screw with the Torx 25 Screwdriverbit connected to the Ratchet and tighten the Screw until it is fully seated.

NOTE: Make sure the Bone Screw is fully seated in order to avoid mechanical contact between Glenosphere backside and Bone Screw head.

Apply the same procedure for the inferior Bone Screw.



Figure 6.78

6.3.4.3 Posterior and Anterior Bone Screws



Figure 6.79

Insert the A/P monoaxial Drill Guide into the posterior screw hole. The Drill Guide determines the direction of the screw. Drill the screw hole with the Ø 3.2 mm Drill to the desired depth.



Figure 6.80

The required screw length is determined with the Depth Gauge. Select the required screw type from Ø 6.0 mm cancellous Bone Screws, Ø 4.5 mm cortical Bone Screws or Ø 4.5 mm angle-stable cortical Bone Screws. Insert the selected Bone Screw with the Torx 25 Screwdriverbit, which is connected to the Ratchet, and tighten it until it is fully seated.

NOTE: Make sure the Bone Screw is fully seated in order to avoid mechanical contact between Glenosphere backside and Bone Screw head.

Apply the same procedure for the anterior screw.

6.3.5 Glenospheres

NOTE: LINK Embrace Glenospheres made of EndoDur are available in 36, 39 and 42 mm diameters in both neutral (concentric) and eccentric versions. They are to be combined with Reverse Inserts made of UHMWPE with the same diameter. LINK Embrace Glenospheres made of UHMWPE are available in 39 mm and 42 mm diameters in both neutral (concentric) and eccentric versions. They are to be combined with Reverse Inserts made of EndoDur with the same diameter. All Glenospheres are fixed in the Reverse Glenoid Baseplate or in the Convertible Glenoid Metal-Back respectively with a taper connection and a pre-assembled locking screw.

LINK Embrace Glenospheres made of UHMWPE consist of the Glenosphere PE-Dome (made of UHMWPE) and a Metal Core. These components are assembled during the surgery by means of a press.

All LINK Embrace Glenospheres have an overhang of the dome which has to be placed inferiorly.

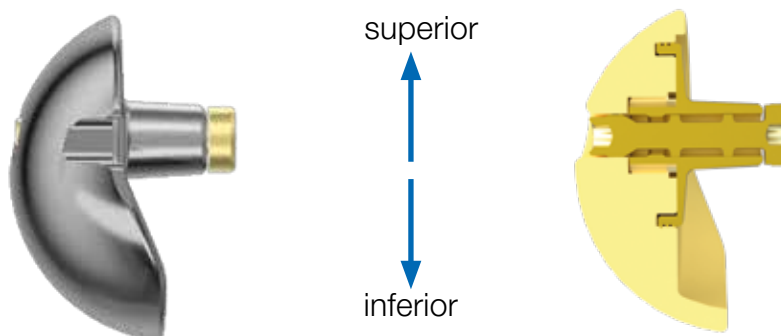

Figure 6.81

6.3.5.1 Trial Glenospheres

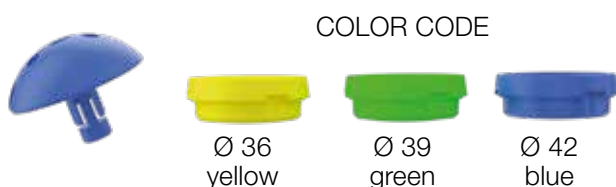

Figure 6.82

After implantation of the Reverse Glenoid Baseplate and appropriate preparation of the humeral component, a trial reduction may be performed using the neutral (concentric) or eccentric Trial Glenospheres of the required diameter. The sizes of the Trial Glenospheres and Reverse Trial Inserts are color coded:

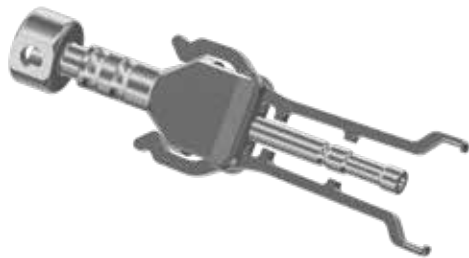

Figure 6.83

The required Trial Glenosphere is placed on the Reverse Glenoid Baseplate by means of the Handle for Glenospheres.



Figure 6.84

To do so, turn the knob of the instrument counter-clockwise to open the branches. According to the type of Glenosphere used, select the Cap for neutral (short) or the Cap for eccentric Glenospheres (long) respectively and slide it on the central Handle rod between the branches. When using the Cap for eccentric Glenospheres make sure the Cap is aligned with the recessing side of the tip inferiorly.



Figure 6.85

Place the required Trial Glenosphere in the Handle with the branches positioned in the lateral grooves of the Glenosphere. Make sure Handle and Glenosphere are axially aligned and the Cap is flush with the Glenosphere. Turn the instrument knob clockwise to close the branches and to fix the Trial Glenosphere.

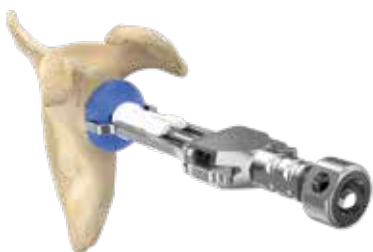

Figure 6.86

With the Handle, insert the Trial Glenosphere and press it firmly into the Reverse Baseplate to engage the taper connection.



Figure 6.87

Make sure the Trial Glenosphere does not interfere with bone or soft tissue, in particular on the superior edge. In case of contact to bone or other tissue, remove the component and excise the bone or tissue in the area of contact. Then reintroduce the Trial Glenosphere.

Remove the Handle for Glenospheres by turning the knob counterclockwise.

With the humeral trial component completely prepared, perform a trial reduction.

6.3.5.2 UHMWPE Glenospheres: Assembly

NOTE: LINK Embrace UHMWPE Glenospheres consist of a E-Dur UHMWPE-Dome and a Metal Core made of EndoDur (coated with TiNbN). The two components are assembled on the sterile table by means of a Press.

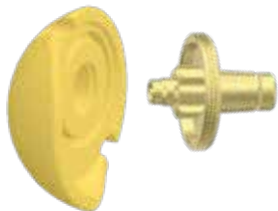

Figure 6.88

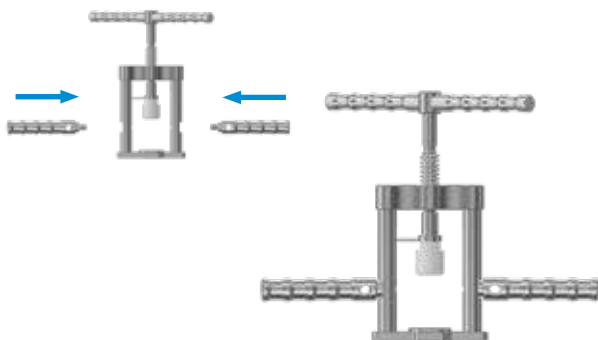

Figure 6.89

Assemble the Press. Screw the two Handles into the side bars of the Press Base.

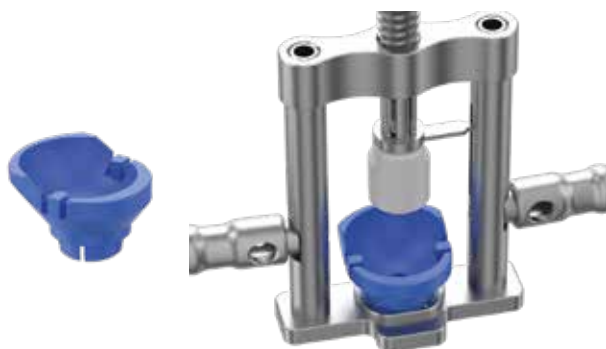

Figure 6.90

Open the Press completely by turning the Press handle counterclockwise. Select the appropriate Glenosphere Support according to the Glenosphere chosen (diameter 39 mm or 42 mm, neutral or eccentric) and place it in the Press base.



Figure 6.91

Insert the required Glenosphere PE-Dome with the back side facing upwards into the Support and align it with its rim flush with the Support. Make sure the two Support pins are aligned with the grooves at the Glenosphere Dome rim.

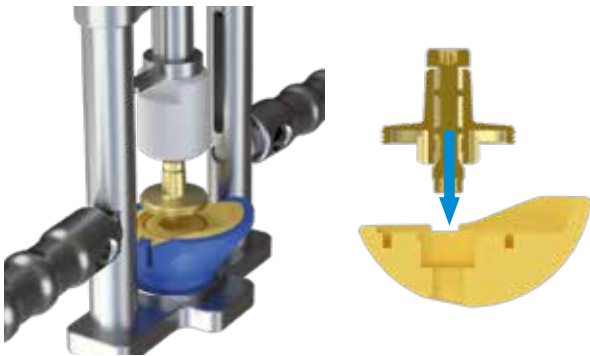

Figure 6.92 (cross section)

Insert the Metal Core with the flanged end downwards into the PE-Dome, placing the flange rim and the central cylindrical part into the corresponding grooves and holes within the PE-Dome.



Figure 6.93

Turn the Press handle clockwise which will slide the Press sleeve over the Metal Core taper. During pressing, make sure the components are axially aligned to each other and the Core flange gets in full circumferential contact with the PE-Dome.

Press the Core into the PE-Dome by continued clockwise turning the Press handle until the collar-shaped flange of the Core is in full contact with the backside surface of the PE-Dome.



Figure 6.94, assembled PE-Glenosphere (left: cross section without fixation screw, right: backside view)

NOTE: The correct assembly of Glenosphere PE-Dome and Metal Core is visually checked afterwards, considering these criteria:

- The Core flange lies flush on the PE-Dome backside surface
- The Core does not show any tilting
- The pre-assembled screw in the Core is rotatable
- The screw head is freely accessible with the Torx 20 Screwdriver through the Glenosphere PE-Dome opening
- No deformation of the PE-Dome and Metal Core is visible.

If the Metal Core is not completely seated, use the Press again.

6.3.5.3 Glenospheres: Implantation

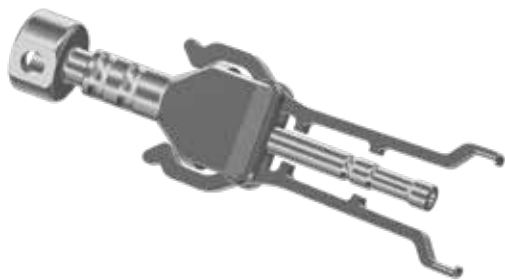

Figure 6.95

If used, remove the Trial Glenosphere.

The required Glenosphere is placed on the Reverse Glenoid Baseplate by means of the Handle for Glenospheres.

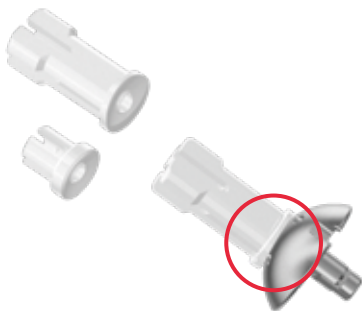

Figure 6.96

To do so, turn the instrument knob counterclockwise to open the branches.

According to the type of Glenosphere used, select the Cap for neutral (short cap) or the Cap for eccentric Glenospheres (long cap) respectively and slide it on the central Handle rod between the branches. When using the Cap for eccentric Glenospheres make sure the Cap is aligned with the recessing part of the tip inferiorly.



Figure 6.97

Place the required Glenosphere in the Handle with the branches positioned in the lateral grooves of the Glenosphere. Make sure Handle and Glenosphere are axially aligned and the Cap is flush with the Glenosphere.

Turn the instrument knob clockwise to close the branches and fix the Glenosphere.



Figure 6.98

NOTE: In case a central Bone Screw is implanted, recheck the full seating of the Screw prior to Glenosphere insertion in order to avoid any contact between Bone Screw Head and Glenosphere fixation screw.

Insert the Glenosphere into the Reverse Baseplate. Make sure the component overhang is positioned inferiorly and the taper engages with the inner taper of the Reverse Baseplate (or the Convertible Metal-Back in conversion cases respectively). Make sure the Glenosphere does not interfere with bone or soft tissue, in particular at the superior edge. In case of contact to bone or other tissue, remove the component and excise the bone or tissue in the area of contact. Then reintroduce the Glenosphere. Carefully impact the Glenosphere with slight mallet blows onto the Handle impactation plate to engage the taper connection.

Check the seating of the taper connection by gently applying rotational forces with the Handle. The taper is engaged when the Glenosphere resists against axial and rotational forces.

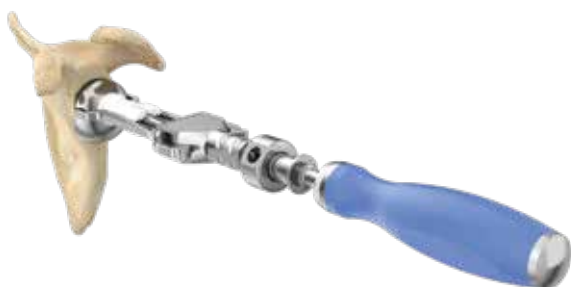

Figure 6.99

Connect the Torx 20 Screwdriverbit to the 3 Nm Torque Wrench. Slide the assembled Screwdriver through the Handle for Glenospheres. Tighten the internal fixation screw by turning the 3 Nm Torque Wrench clockwise. The required torque of 3 Nm is reached when a clicking noise can be heard.



Figure 6.100

Remove the Torque Wrench and the Handle for Glenospheres by turning the Handle knob counterclockwise.

With the humeral components/trial components completely prepared, perform a trial reduction.

6.4 Reverse Humeral Component Trialing

NOTE: The LINK Embrace System offers three different Reverse Trays and Trials to accommodate Reverse Inserts. Reverse Trays are mounted on the humeral components (Compressors, Humeral Standard and Short Stems, Proximal Bodies, Humeral Fracture Stems, Stemless Cages (in conversion scenarios with well fixed Stemless Cage). Reverse Trays come in neutral (concentric), 10° inclined and 3 mm offset versions.



Figure 6.101



Figure 6.102

Reverse Trial Trays in inclined and offset versions as well as the respective final Reverse Trays can be rotated in 45° steps to individually adjust various parameters such as inclination, retroversion, (posterior) offset and humerus lateralization. A scale on the Tray front side is used to determine the orientation of both the Reverse Tray and the Reverse Insert. It helps with later reproduction of the selected trial configuration with the final prosthesis components. It is recommended to start trialing with a neutral Reverse Tray.



Figure 6.103

LINK Embrace Reverse Inserts are available in different diameters, heights, inclinations and materials according to table 6.1. They have to be combined with LINK Embrace Glenospheres of the same diameter.

Reverse Humeral Inserts			
Diameter Ø	Inclination	Heights	
		UHMWPE	EndoDur
36	0°	0, 3, 6	X
	10°	0, 3, 6	X
	20°	0, 3, 6	X
39	0°	0, 3, 6	-3, 0, 3, 6
	10°	0, 3, 6	-3, 0, 3, 6
	20°	0, 3, 6	0, 3, 6
42	0°	0, 3, 6	-3, 0, 3, 6
	10°	0, 3, 6	-3, 0, 3, 6
	20°	0, 3, 6	0, 3, 6
to be combined with Glenospheres made of:		EndoDur	UHMWPE

Table 6.1: Reverse Inserts: types and allowed combinations. Numerical data in mm unless otherwise noted.



Figure 6.104

All LINK Embrace Reverse Inserts can be fixed in any position on the Reverse Trays/Stemless Ring Cage/Humeral Extender. In combination with a Reverse Tray, different parameters such as inclination and retroversion can be adjusted independently in the respective spatial planes.

In Reverse Trial Inserts with inclination as well as in the respective final Reverse Inserts a line mark indicates the highest point, which is used to determine the orientation of the Reverse Trial Insert. It helps with later reproduction of the selected trial configuration with the final prosthesis components.

It is recommended to start trialing with a neutral Reverse Insert with height 0.

6.4.1 Stemless Ring Cage Trialing

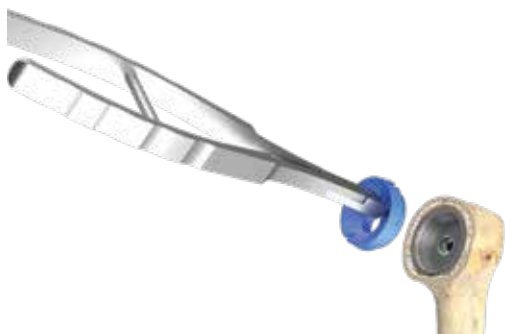

Figure 6.105

Select the suitable Reverse Trial Insert (diameter and height).

NOTE: The LINK Embrace System includes Reverse Inserts and trial components in various diameters, inclinations and heights. It is recommended to start with a neutral (0° inclination) Reverse Trial Insert with 0 mm height.

Using the Insertion Forceps, place the Reverse Trial Insert in the Punch or the Cage.

Perform a trial reduction to check stability, tension and function of the joint.

NOTE: If required, the joint configuration may be adapted by selecting a Reverse Trial Insert with different height and/or inclination. In case an inclined Reverse Insert is used, note the position of the mark indicating the highest point.

NOTE: Stemless Ring Cages size 34 can not be coupled with Reverse Inserts made of UHMWPE. In this case, a Reverse Insert made of EndoDur must be used in combination with a PE-Glenosphere.

In the event that a Reverse Trial Insert of height 6 and other measures do not result in sufficient joint stability, a Humeral Extender may be used. The Extender corresponds to a height of 9 mm and can accommodate any Reverse Trial Insert/Reverse Insert. Use the Humeral Trial Extender combined with an appropriate Reverse Trial Insert to perform a trial reduction.

NOTE: When using the Humeral Extender, care must be taken not to overstretch the surrounding soft tissues.

Go on with chapter 6.5.1.



Figure 6.106

6.4.2 Humeral Standard and Short Stem Trialing



Figure 6.107

Place the neutral Reverse Trial Tray on the humeral component and press it down firmly until it is fully seated. A spring-loaded clamp connection fixes the Trial Tray to the humeral component.

Select the suitable Reverse Trial Insert (diameter and height).

NOTE: The LINK Embrace System includes Reverse Inserts and trial components in various diameters, inclinations and heights. It is recommended to start with a neutral (0° inclination) Reverse Trial Insert with 0 mm height.

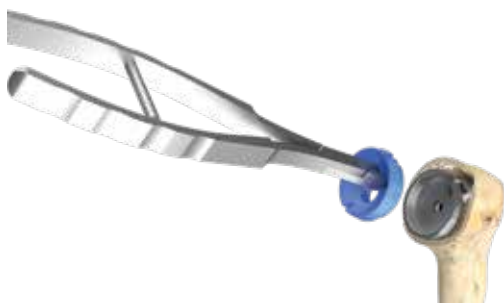

Figure 6.108

Using the Insertion Forceps, place the Reverse Trial Insert in the Reverse Trial Tray.

Perform a trial reduction to check stability, tension and function of the joint.



Figure 6.109

NOTE: If required, the joint configuration may be adapted by selecting a Reverse Trial Tray with offset or inclination and/or Reverse Trial Inserts with different height and/or inclination. Reverse Trial Trays and final Reverse Trays have a dial-like ring on their front side used to precisely determine and reproduce the selected position. For this purpose, the most laterally located digit on the Trial is noted and the final Reverse Tray is later on positioned accordingly with the same digit most laterally. In case an inclined Reverse Insert is used, the position of the mark indicating the highest point is noted as well.



Figure 6.110

In the event that a Reverse Trial Insert of height 6 and other measures do not result in sufficient joint stability, a Humeral Extender may be used. The Extender corresponds to a height of 9 mm and can accommodate any Reverse Trial Insert/ Reverse Insert. Use the Humeral Trial Extender combined with an appropriate Reverse Trial Insert to perform a trial reduction.

NOTE: When using the Humeral Extender, care must be taken not to overstretch the surrounding soft tissues.

Go on with chapter 6.5.2.

6.4.3 Proximal Body, Modular Stem/Modular Revision Stem and Humeral Fracture Stem Trialing (FX)

6.4.3.1 Proximal Body, Modular Stem/Modular Revision Stem Trialing (FX)



Figure 6.111

Place the neutral Reverse Trial Tray on the humeral component and press it down firmly until it is fully seated. A spring-loaded clamp connection fixes the Trial Tray to the humeral component.

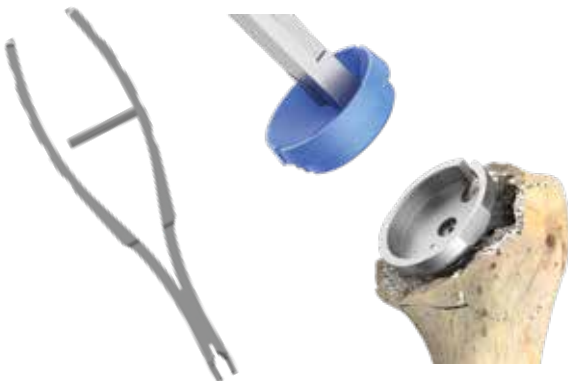

Figure 6.112

Select the suitable Reverse Trial Insert (diameter and height).

NOTE: The LINK Embrace System includes Reverse Inserts and trial components in various diameters, inclinations and heights. It is recommended to start with a neutral (0° inclination) Reverse Trial Insert with 0 mm height.

Using the Insertion Forceps, place the Reverse Trial Insert in the Reverse Trial Tray.



Figure 6.113

Perform a trial reduction to check stability, tension and function of the joint.

NOTE: If required, the joint configuration may be adapted by selecting a Reverse Trial Tray with offset or inclination and/or Reverse Trial Inserts with different height and/or inclination. Reverse Trial Trays and final Reverse Trays have a dial-like ring on their front side used to precisely determine and reproduce the selected position. For this purpose, the most laterally located digit on the trial is noted and the final Reverse Tray is later on positioned accordingly with the same digit most laterally. In case an inclined Reverse Insert is used, the position of the mark indicating the highest point is noted as well.

NOTE: Both the Reverse Trial Trays and the Reverse Trial Inserts have a cut out. Align both cut outs in lateral position in order to easily change the retroversion using the Screwdriver without removing the trial components. To do this, push the Torx 25 Screwdriverbit connected to the Ratchet through the cut outs into the preassembled locking screw within the Proximal Body and untighten it slightly. The retroversion can now be adjusted. Finally, retighten the locking screw and remove the Screwdriver. Repeat the trialing.

If no further adjustments are required, the selected retroversion can be marked on the bone, e.g. with electric cauter, according to the line marking on the Proximal Trial Body.

The implantation level can now also be transferred from the ruler to the bone for reproduction during implantation of the final component.

In the event that a Reverse Trial Insert of height 6 and other measures do not result in sufficient joint stability, a Humeral Extender may be used. The Extender corresponds to a height of 9 mm and can accommodate any Reverse Trial Insert/Reverse Insert. Use the Humeral Trial Extender combined with an appropriate Reverse Trial Insert to perform a trial reduction.

NOTE: When using the Humeral Extender, care must be taken not to overstretch the surrounding soft tissues.

Go on with chapter 6.5.3.



Figure 6.114

6.4.3.2 Humeral Fracture Stem Trialing (FX)

NOTE: The LINK Embrace System offers monoblock Humeral Fracture Stems in sizes 12, 13, ..., 24 for simple and fast treatment of humeral fractures. The proximal shape of these monoblock Stems corresponds to a Proximal Body of height 0, whereby the proximal diameter grows harmoniously with increasing size. Distally, monoblock Fracture Stems correspond to a Modular Stem of the same size with 75 mm length.

Trial components for sizes 12 and 13 come as a monoblock. For all other sizes, the humeral trial component is assembled using the corresponding size of the 75 mm Modular Trial Stem and the Proximal Trial Body with height 0 and size M. In consequence, assembled trial components and final components have slightly different volume in the proximal section. This must be taken into account for the subsequent reattachment of the tuberosities.

- Prepare the humerus and determine the required diameter of the Modular Stem as described in 6.2.3.
- For sizes 12 and 13, perform trial reduction with the Humeral Fracture Trial Stems (monoblock) provided.
- For sizes 14 - 24, combine Modular Trial Stems L 75 mm of the required diameter with the Proximal Trial Body with height 0 and size M. Assemble the components as described in 6.2.3.
- Determine the required height of the component. To do so, connect the Template for Proximal Bodies to the Handle for Compressors and Proximal Bodies and attach the Humeral Fracture Trial Stem to the Handle. Go on as described in 6.2.3.
- Assemble Reverse Trial Tray and Reverse Trial Insert as described in 6.4.3.1.
- Perform the trial reduction as described in 6.4.3.1 correspondingly.

Go on with chapter 6.5.3.1 (cementless implantation) or chapter 6.5.3.2 (cemented implantation).

6.5 Humeral Components: Implantation

6.5.1 Stemless Ring Cage Implantation

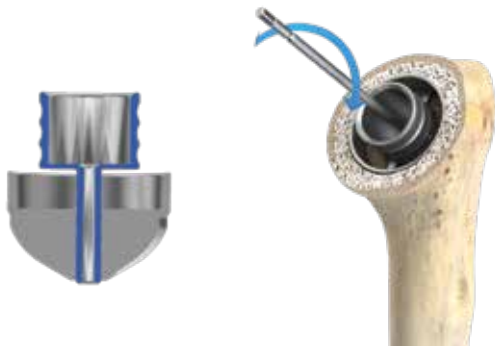

Figure 6.115

Introduce the Sizing Sleeve with the tubed end into the Punch/Trial Cage for Stemless Ring Cage located in situ.

Using a power tool, introduce the K-Wire for Stemless Preparation through the Sleeve into the bone and lock it in the cortical wall. Remove the Sizing Sleeve.

Remove the Punch/Trial Cage for Stemless Cage using the Impactor for Stemless Cages/Ring Cages. The K-Wire remains in situ and serves as a guide for the implantation of the Stemless Ring Cage.



Figure 6.116

Select the Stemless Ring Cage of the same size as the last Punch/Trial Cage for Stemless Ring Cage used and screw it on the Impactor for Stemless Cages/Ring Cages.



Figure 6.117

Axially insert the Cage over the K-Wire into the situs and align the Cage wings according to the prepared implant bed. A laser mark inside the Stemless Ring Cage indicates the position of the four backside flanges.

At first, the Stemless Ring Cage should not be completely impacted but protrude slightly from the humerus. This facilitates the complete coupling of the taper connection between Stemless Ring Cage and the Reverse Insert. Remove the K-Wire with the Pin Inserter/Extractor.

In case a Humeral Extender is required, place the required Reverse Insert in the Extender and impact it on the sterile table using the convex Impactor. Correspondingly go on with the next steps as described.

Place the Reverse Insert of the required type, diameter and height and align it according to the configuration determined with the trial reduction.

NOTE: Stemless Ring Cages size 34 can not be coupled with Reverse Inserts made of UHMWPE. In this case, a Reverse Insert made of EndoDur must be used in combination with a PE-Glenosphere.



Figure 6.118

Impact the Reverse Insert with the convex Impactor. The entire prosthesis is carefully impacted into the humerus until the Cage is flush with the resection plane.

Perform reduction and final check.

6.5.2 Humeral Standard and Short Stem Implantation

6.5.2.1 Cementless Humeral Standard and Short Stem Implantation

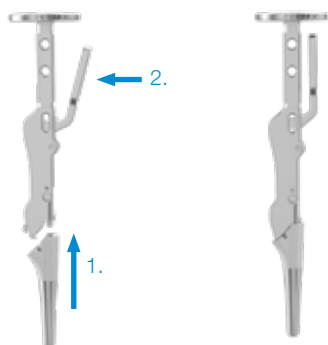

Figure 6.119

NOTE: For cementless implantation, the Humeral Standard or Short Stem of the same size as the last Compressor is used. Compressors and Stems with the same size designation have identical dimensions (Compressors have + 5 mm length).

Remove the transportation lock (white plastic cover) from the selected Humeral Stem.
Connect the Humeral Stem to the Handle.



Figure 6.120

Impact the Humeral Stem taking into account the desired retroversion. For this purpose, the Alignment Rod is screwed into the appropriate hole in the Handle impactation plate rim. Make sure to select the correct set of holes for left and right side treatment.



Figure 6.121

Alternatively, place the Alignment Rod Connector on the Handle and insert the Alignment Rod in the appropriate hole. Make sure to select the correct position of the Alignment Rod Connector for left and right side treatment.

At first, the Humeral Stem should not be completely impacted but protrude slightly from the humerus. This facilitates the complete coupling of the taper connection between Humeral Stem and Reverse Tray.



Figure 6.122

Place the required Reverse Tray, reproducing the configuration selected in the trial reduction. For offset and inclined Reverse Trays, the same digit as the digit determined with the trial prosthesis must be aligned laterally.



Figure 6.123

Insert the Fixation Screw into the Reverse Tray (supplied with the Reverse Tray).



Figure 6.124

Connect the Torx 25 Screwdriverbit to the 3 Nm Torque Wrench.



Figure 6.125

Position the tips of an appropriate instrument, e.g. a LINK Bankart Perforating Forceps (item code 64-4160/09) into the grooves of the Reverse Tray and hold the instrument firmly.



Figure 6.126

Introduce the prepared Screwdriver into the Fixation Screw within the Reverse Tray. Tighten the Screw by turning the Screwdriver clockwise while holding the Forceps firmly in place with your other hand. The required torque of 3 Nm is reached when a clicking noise can be heard.

In case a Humeral Extender is required, place the required Reverse Insert in the Extender and impact it on the sterile table using the convex Impactor. Correspondingly go on with the next steps as described.

Place the required Reverse Insert (diameter, inclination and height) on the Reverse Tray, reproducing the configuration determined with the trial reduction. Use the marks at the highest point of inclined Reverse Inserts and the scale on offset and inclined Reverse Trays to do so.



Figure 6.127

Impact the Reverse Insert with the convex Impactor for Reverse Inserts and Glenoids until the gap between Insert and Tray is completely closed. The entire prosthesis is carefully impacted into the humerus until the Reverse Tray underside rests on the bone surface.



Figure 6.128

Perform reduction and final check. If adjustments are necessary, both Reverse Insert and Reverse Tray can be removed. For further information on component removal, refer to chapter 8.

6.5.2.2 Cemented Humeral Standard Stem Implantation

NOTE: For cemented implantation, select the Humeral Standard Stem one or two sizes smaller than the last Compressor used. When selecting the Humeral Stem one size smaller than the last Compressor, a cement mantle thickness of approx. 0.5 mm is achieved.

NOTE: Alternatively to assembling the component in situ as described here, it is recommended to completely assemble the humeral component on the sterile table and insert it as a whole afterwards in axial alignment. In this case, follow the workflow described here correspondingly.

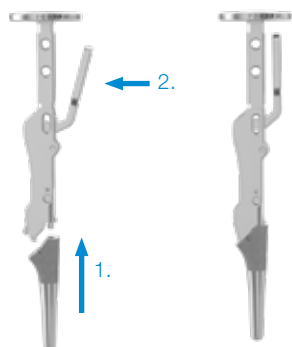

Figure 6.129

The use of high viscosity cement is recommended for cementation.

Remove the transportation lock (white plastic cover) from the selected Humeral Stem.

Connect the Humeral Stem to the Handle.



Figure 6.130

Clean the bone using jet or pulse lavage and apply the cement.

Insert the Humeral Stem into the soft cement taking into account the desired retroversion. For this purpose, the Alignment Rod is screwed into the appropriate hole in the Handle impactation plate rim. Make sure to select the correct set of holes for left and right side treatment.



Figure 6.131

Alternatively, place the Alignment Rod Connector on the Handle and insert the Alignment Rod in the appropriate hole. Make sure to select the correct position of the Alignment Rod Connector for left and right side treatment.



Figure 6.132

Manually press down the Stem into the soft cement until it is positioned at the same level as the last Compressor used. Remove excessive bone cement. With the Handle, the prosthesis is held in position until the cement is cured.



Figure 6.133

Remove the Handle
Assemble the Reverse Tray, Humeral Extender (if required) and Reverse Insert as described in 6.5.2.1. Perform reduction and final check.
If adjustments are necessary, both Reverse Insert and Reverse Tray can be removed.
For further information on component removal, refer to chapter 8.

6.5.3 Proximal Body, Modular Stem/Modular Revision Stem and Humeral Fracture Stem Implantation (FX)

6.5.3.1 Cementless Proximal Body, Modular Stem/Modular Revision Stem and Humeral Fracture Stem Implantation (FX)

NOTE: In cementless application, Modular Stem/Modular Revision Stem and Proximal Body are assembled in situ.

NOTE: Humeral Fracture Stems have a monoblock design and therefore don't need to be assembled. In order to implant Humeral Fracture Stems, connect the required Stem to the Handle for Compressors and Proximal Bodies and follow the workflow described in this chapter correspondingly.



Figure 6.134

Connect the required Modular Stem/Modular Revision Stem determined with the trial reduction to the Handle for Modular Stems (threaded connection).

Attach the Template for Proximal Bodies to the Handle.

Introduce the Modular Stem/Modular Revision Stem into the humerus and impact until good stability is achieved.

Using the Template for Proximal Bodies, check the position of the final Modular Stem/ final Modular Revision Stem.

NOTE: Another trial reduction can be performed at this stage (suggested in case the final Stem position differs from the Trial Stem position). Proximal Trial Bodies can be connected to the final Modular Stem/ final Modular Revision Stem in situ to determine the appropriate final Proximal Body height.

Remove the Handle and Template.

Remove the transportation lock (white plastic cover) from the final Proximal Body determined with the trial reduction.

NOTE: LINK Embrace Proximal Bodies and Modular Stems/Modular Revision Stems are fixed to each other by a taper connection. A pre-assembled locking screw inside the Proximal Body is used to tighten the coupling. This is done by means of a Torx 25 Screwdriverbit and a 5 Nm Torque Wrench. When pushing the Screwdriverbit into the locking screw, make sure the line mark for the respective height of the Proximal Body on the Screwdriverbit is at the level of the Handle impaction plate. This indicates that the Screwdriverbit is fully inserted into the locking screw head.

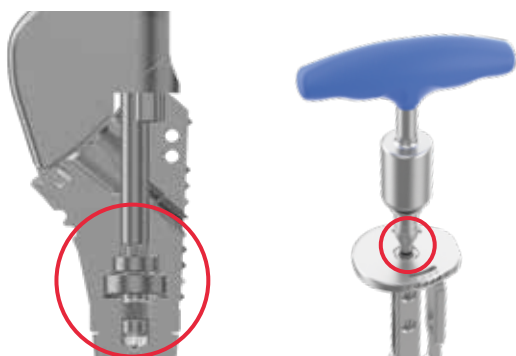

Figure 6.135



Figure 6.136

Connect the Proximal Body to the Handle for Compressors and Proximal Bodies and place it on the Modular Stem/Modular Revision Stem in situ. Do not impact.

Connect the Torx 25 Screwdriverbit to the 5 Nm Torque Wrench and slide it through the Handle into the head of the preassembled locking screw within the Proximal Body.

Slightly turn the locking screw just until the threaded connection of screw and Stem engages, leaving the Proximal Body freely rotatable on the Modular Stem. Align the required retroversion using the Alignment Rod screwed into the appropriate hole in the Handle impaction plate.

Alternatively, align the retroversion with the Alignment Rod screwed into the appropriate hole of the Alignment Rod Connector which is connected to the Handle.

Tighten the locking screw within the Proximal Body using the 5 Nm Torque Wrench and the Torx 25 Screwdriverbit. The required torque is reached when a clicking noise can be heard.

Remove Screwdriver and Handle.

Optionally, you may now perform another trial reduction with a Reverse Trial Tray and Reverse Trial Insert. Adapt the configuration if necessary.

Place the required Reverse Tray, reproducing the configuration selected in the trial reduction. For offset and inclined Reverse Trays, the same digit as the digit determined with the trial prosthesis must be aligned laterally.



Figure 6.137



Figure 6.138

Insert the Fixation Screw into the Reverse Tray (supplied with the Reverse Tray).



Figure 6.139

Connect the Torx 25 Screwdriverbit to the 3 Nm Torque Wrench.



Figure 6.140

Position the tips of an appropriate instrument, e.g. a LINK Bankart Perforating Forceps (item code 64-4160/09) into the grooves of the Reverse Tray and hold the instrument firmly.



Figure 6.141

Introduce the prepared Screwdriver into the Fixation Screw within the Reverse Tray. Tighten the Screw by turning the Screwdriver clockwise while holding the Forceps firmly in place with your other hand. The required torque of 3 Nm is reached when a clicking noise can be heard.



Figure 6.142

If required, sutures can be attached using the m-l and a-p holes of the Proximal Body for tuberosities reattachment.

In case a Humeral Extender is required, place the required Reverse Insert in the Extender and impact it on the sterile table using the convex Impactor. Correspondingly go on with the next steps as described.



Figure 6.143

Place the required Reverse Insert (diameter, inclination and height) on the Reverse Tray, reproducing the configuration determined with the trial reduction. Use the marks at the highest point of inclined Reverse Inserts and the scale on offset and inclined Reverse Trays to do so.

Impact the Reverse Insert with the convex Impactor for Reverse Inserts and PE-Glenoids until the gap between Insert and Tray is completely closed.



Figure 6.144

Perform reduction and final check.

If adjustments are necessary, both Reverse Insert and Reverse Tray can be removed.

For further information on component removal, refer to chapter 8.

6.5.3.2 Cemented Proximal Body, Modular Stem/Modular Revision Stem and Humeral Fracture Stem Implantation (FX)

NOTE: For cemented implantation, select the Modular Stem/Modular Revision Stem or the Humeral Fracture Stem (monoblock) one or two sizes smaller than the last Trial Stem or Humeral Fracture Trial Stem used. Modular Trial Stems/Fracture Trial Stems and final Modular Stems/final Humeral Fracture Stems with the same size designation have identical intramedullar stem dimensions. When selecting the final component one size smaller than the corresponding trial component, a cement mantle thickness of approx. 0.5 mm is achieved.

NOTE: In cemented application, Modular Stem/ Modular Revision Stem and Proximal Body are assembled on the sterile table. It is recommended to completely assemble the humeral component on the sterile table and insert it as a whole afterwards in axial alignment.

NOTE: Humeral Fracture Stems have a monoblock design and therefore don't need to be assembled. In order to implant Humeral Fracture Stems, connect the required Stem to the Handle for Compressors and Proximal Bodies and follow the workflow described in this chapter correspondingly.

The use of high viscosity cement is recommended for cementation.

Remove the transportation lock (white plastic cover) from the final Proximal Body determined with the trial reduction.

Connect the Proximal Body to the Handle for Compressors and Proximal Bodies.

Connect the Proximal Body to the required Modular Stem/Modular Revision Stem and tighten the locking screw within the Proximal Body as described in chapter 6.5.3.1.

Connect the Template for Proximal Bodies to the Handle.

Clean the bone using jet or pulse lavage and apply the cement.

Insert the assembled humeral component into the soft cement taking into account the desired retroversion.

For this purpose, the Alignment Rod is screwed into the appropriate hole in the Handle impaction plate rim. Make sure to select the correct set of holes for left and right side treatment.



Figure 6.145



Figure 6.146

Alternatively, place the Alignment Rod Connector on the Handle and insert the Alignment Rod in the appropriate hole. Make sure to select the correct position of the Alignment Rod Connector for left and right side treatment.



Figure 6.147

Manually press down the humeral component into the soft cement until the Template for Proximal Bodies indicates the previously defined component level. Remove excessive bone cement. With the Handle, the prosthesis is held in position until the cement is cured.



Figure 6.148

Remove the Handle. Assemble the Reverse Tray, Humeral Extender (if required) and Reverse Insert as described in 6.5.3.1. Perform reduction and final check. If adjustments are necessary, both Reverse Insert and Reverse Tray can be removed.

For further information on component removal, refer to chapter 8.

7. Conversion of Anatomic to Reverse Configuration

The LINK Embrace System allows for conversion from anatomic to reverse joint configuration without removing the intramedullar humeral components. After retrieval of the anatomic components Humeral Head and Head Adapter these are replaced by a Reverse Tray and a Reverse Insert. If required, different types of Reverse Trays and Reverse Inserts allow for adaption of joint parameters such as inclination and retroversion.

In cases of a primarily implanted modular humeral component (Proximal Body and Modular Stem/Modular Revision Stem), the design allows for adaption of the retroversion by isolated realignment of the Proximal Body. In cases of a primarily implanted and well integrated Stemless Cage in anatomic configuration, this component may be converted to a reverse configuration by retrieving both Humeral Head and Head Adapter and replacing them with an appropriate Reverse Tray and Reverse Insert.

In cases of a primarily implanted and well fixed Stemless Ring Cage in anatomic configuration (with Stemless Ring Cage Adapter), this component may be converted to a reverse configuration by retrieving both Humeral Head and Stemless Ring Cage Head Adapter and replacing them with an appropriate Reverse Insert.

In case of a primarily implanted and well fixed Convertible Glenoid, this may be used to host a Glenosphere after removal of the initially implanted anatomic PE-Glenoid Insert.

NOTE: For detailed information on disassembly and retrieval of implanted components refer to chapter 8 Component Removal.

7.1 Conversion of Anatomic Configurations with Humeral Standard and Short Stems, Humeral Fracture Stems and Stemless Cages into Reverse Configuration

- Remove the Humeral Head using the Separator Wrench as described in 8.1.
- Remove the Fixation Screw within the Head Adapter using the Torx 25 Screwdriver connected to the Ratchet by turning it counterclockwise as described in 8.1.
- Remove the Head Adapter using the Extraction Bolt as described in 8.1.
- Assemble and adjust the reverse configuration as described in chapter 6.

7.2 Conversion of Anatomic Configurations with Proximal Bodies, Modular Stem/Modular Revision Stems (FX) into Reverse Configuration

- Remove the Humeral Head using the Separator Wrench as described in 8.1.
- Remove the Fixation Screw within the Head Adapter using the Torx 25 Screwdriver connected to the Ratchet by turning it counterclockwise as described in 8.1.
- Remove the Head Adapter using the Extraction Bolt as described in 8.1.
- If required, adapt the retroversion using the Reverse Tray in inclined or offset version as described in 6.4.3.1.
- Assemble and adjust the reverse configuration as described in chapter 6.

7.3 Conversion of Anatomic Configurations with Stemless Ring Cages into Reverse Configuration

- Remove the Humeral Head using the Separator Wrench as described in 8.1.
- Remove the Stemless Ring Cage Head Adapter with the Extraction Bolt as described in 8.4.
- Assemble and adjust the reverse configuration as described in chapter 6.

7.4 Conversion of Anatomic Glenoids into Reverse Configuration

7.4.1 Native Glenoid

In case of a native glenoid, implant a Reverse Glenoid Baseplate as described in chapter 6.

7.4.2 Cemented All-Poly Glenoid

In case of an implanted UHMWPE glenoid, remove the component as described in 8.6.

NOTE: When replacing a Cemented All Poly Glenoid with a Reverse Glenoid Baseplate or in other revision scenarios, it may be recommended to use a Reverse Glenoid Baseplate with a long peg for increased stability.

7.4.3 Convertible Glenoid

In case a LINK Embrace Convertible Glenoid has been implanted in a previous TSA, it may be converted to a reverse configuration and host a Glenosphere in the course of a revision. The prerequisite for this is a stable integration of the Convertible Glenoid into the bone substance of the scapula.

NOTE: The following table shows the allowed combinations of the four Convertible Glenoid sizes with the single LINK Embrace Glenospheres. When converting into a reverse configuration, make sure the combination chosen is in accordance to this table.

Convertible Glenoid Size	Glenosphere Type (material, type, diameter)										
	EndoDur						UHMWPE				
	neutral			eccentric			neutral		eccentric		
	36	39	42	36	39	42	39	42	39	42	
small	✓	✓	✓	✓	✓	✓	✓	✓	✓	✓	✓
medium	✓	✓	✓	✓	✓	✓	✓	✓	✓	✓	✓
large	✗	✓	✓	✗	✓	✓	✗	✓	✓	✓	✓
x-large	✗	✗	✗	✗	✗	✗	✗	✗	✗	✗	✗

Table 7.1: Allowed combinations of Convertible Glenoid Metal-Backs and Glenospheres are marked in green. Red combinations are not allowed. Numerical data in mm.

NOTE: LINK Embrace Convertible Glenoids of size XL cannot host a Glenosphere.

Remove the UHMWPE-Insert from the Convertible Glenoid Metal-Back as described in 8.7.

NOTE: When removing the UHMWPE-Insert from the Convertible Glenoid Metal-Back, care must be taken not to damage the inner Metal-Back thread. Check the thread inside the Metal-Back for integrity by fitting the threaded Shaft of the Convertible Glenoid Impactor into the Metal-Back and screw it into the central hole. This should be easily feasible and without any resistance.

8. Component Removal

In cases of conversion or revision, all LINK Embrace components can be removed by means of specifically designed instruments.

8.1 Removal of Humeral Heads and Head Adapters



Figure 8.1

Slide a small chisel into the gap between Humeral Head and Head Adapter or Stemless Ring Cage Head Adapter respectively.

Detach the Humeral Head by circumferential gentle levering with the chisel within the gap.



Figure 8.2

Connect the Torx 25 Screwdriverbit to the Ratchet and slide it through the Counter Sleeve with the small Sleeve pin at the lower end.



Figure 8.3

Introduce the prepared Screwdriver into the Adapter Fixation Screw and position the Sleeve pin in the small hole in the Head Adapter.



Figure 8.4

Untighten the Screw by turning the Screwdriver counterclockwise while holding the Sleeve firmly in place with your other hand.

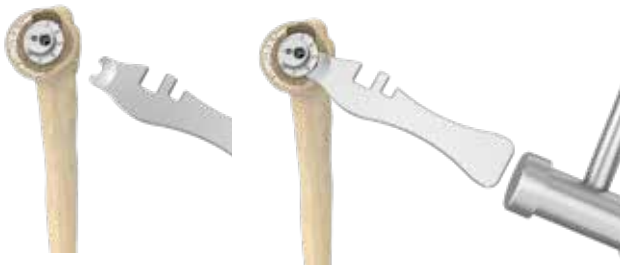

Figure 8.5

Remove all instruments and the Fixation Screw. Slide the Separator Wrench into the gap between Head Adapter and Humeral Component.

Impact the Separator Wrench with light mallet blows. Repeat this procedure at another position in case the component can not be removed.

In case the taper connection of the components cannot be released with the Separator Wrench, apply the Extraction instruments as described subsequently.



Figure 8.6

Slide the Head Adapter Extraction Bolt (M8 thread) through the Counter Sleeve.

Connect the T-Handle to the Extraction Bolt fitting.



Figure 8.7

Position the prepared instrument on the Head Adapter, introducing the threaded tip into the central Head Adapter hole and the Sleeve pin into the small Adapter hole.

Slightly pretighten the Extraction Bolt by turning it clockwise.
Remove the T-Handle and axially impact the Extraction Bolt with a hammer.
Reconnect the T-Handle to the Extraction Bolt.



Figure 8.8

Detach the Head Adapter from the humeral component by turning the T-Handle clockwise, holding the Counter Sleeve with your other hand as a countertorque, until the Adapter is completely separated from the humeral component.

In case of conversion surgery, visually check the female humeral component taper for integrity.
Mount the required reverse components as described in chapter 8.

8.2 Removal of Humeral Standard and Short Stems, Proximal Bodies and Modular Stems/Modular Revision Stems



Figure 8.9

For removal of Humeral Standard and Short Stems, Proximal Bodies with Modular Stems/Modular Revision Stems as well as Humeral Fracture Stems, connect the Handle for Compressors to the humeral component in situ.

Assemble the Extraction device by sliding the Slaphammer over the Stem for Slaphammer. Screw the Extraction device into the threaded hole of the Extraction Hook.



Figure 8.10

Attach the Extraction device to the Handle by sliding the two Hook bolts into the holes at the Handle.

Remove the humeral component by applying appropriate blows with the Slaphammer.



Figure 8.11

For the separate removal of Modular Stems/Modular Revision Stems, remove the Proximal Body first using the long Torx 25 Screwdriverbit connected to the Ratchet.

To do so, mount the Handle for Compressor onto the Proximal Body and slide the Screwdriver through the Handle so that it engages with the locking screw inside the Proximal Body.

Turn the Ratchet counterclockwise, disengaging the taper connection and pushing the Proximal Body off the Modular Stem.

Remove the Screwdriver, Handle and the attached Proximal Body.



Figure 8.12

Screw the Handle for Modular Stems onto the Modular Stem in situ.



Attach the extraction device to the Handle for Modular Stems by sliding the two Hook bolts into the Handle holes.

Remove the Modular Stem by applying appropriate blows with the Slaphammer.

Figure 8.13

8.3 Removal of Reverse Trays and Humeral Extenders



Push a small chisel into the gap between Reverse Insert and Reverse Tray and remove the Insert by circumferential levering with the chisel. To facilitate removal you may turn a Bone Screw through the PE-Insert, pushing the Insert off the Tray.

Figure 8.14



Position the tips of an appropriate instrument, e.g. a LINK Bankart Perforating Forceps (item code 64-4160/09) into the grooves of the Reverse Tray and hold the instrument firmly.

Figure 8.15



Remove the Fixation Screw within the Reverse Tray by turning it counterclockwise using the Torx 25 Screwdriverbit connected to the Ratchet

Figure 8.16



Slide the Separator Wrench into the gap between Reverse Tray and Humeral Component.

Impact the Separator Wrench with light mallet blows. Repeat this procedure at another position in case the component can not be removed.

Figure 8.17

In case the taper connection of the components cannot be released with the Separator Wrench, apply the Extraction instruments as described subsequently.

Connect the Reverse Tray Extraction Bolt to the T-Handle.



Figure 8.18

Introduce the threaded Extractor tip into the Reverse Tray central hole.

Slightly pretighten the Extraction Bolt by turning it clockwise.

Remove the T-Handle and axially impact the Extraction Bolt with a hammer.

Reconnect the T-Handle to the Extraction Bolt.

Turn the handle clockwise while holding the Forceps in place with your other hand.



Figure 8.19

Detach the Reverse Tray from the humeral component by turning the T-Handle clockwise, holding the Forceps with your other hand as a countertorque, until the Tray is completely separated from the humeral component.

In case of revision or conversion surgery, visually check the female taper of the humeral component for integrity.

NOTE: In case a CTA Head has to be implanted, refer to chapter 4.5.

In case reverse components have to be implanted, refer to chapter 6.



Figure 8.20

For removal of a Humeral Extender, push a small chisel into the gap between Humeral Extender and Reverse Tray or Stemless Ring Cage. With the chisel, detach the Extender from the hosting component by levering circumferentially to disconnect the tapers.

8.4 Removal of Stemless Ring Cage Head Adapters

Slide the Head Adapter Extraction Bolt (M8 thread) through the Counter Sleeve.



Figure 8.21



Figure 8.22

Connect the T-Handle to the Extraction Bolt fitting. Position the prepared instrument on the Stemless Ring Cage Head Adapter, introducing the threaded tip into the central Adapter hole and the Sleeve pin into the small Adapter hole.



Figure 8.23

Detach the Adapter from the Stemless Ring Cage by turning the T-Handle clockwise, holding the Counter Sleeve with your other hand as a counter-torque, until the Adapter is completely separated from the Stemless Ring Cage.

In case of revision or conversion surgery, visually check the female taper of the humeral component for integrity.

NOTE: In case a CTA Head has to be implanted, refer to chapter 4.5. In case reverse components have to be implanted, refer to chapter 6.

8.5 Removal of Stemless Cages and Stemless Ring Cages



Figure 8.24

For removal of Stemless Cages and Stemless Ring Cages, screw the Impactor for Stemless Cages/ Stemless Ring Cages (without Sleeve) into the central Cage hole.

Extract the component by applying appropriate mallet blows to the instrument impactation plate in upwards direction.

8.6 Removal of Cemented All Poly Glenoids

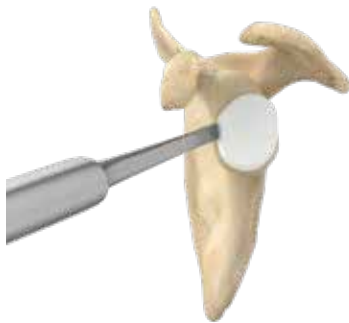

Figure 8.25

In order to remove a PE Glenoid, gently push an appropriate instrument, e.g. a small chisel, into the gap between the cemented PE Glenoid and the bone and loosen the component by carefully levering with the chisel.

Remove the component and bone cement residuals. In case it is intended to implant a new component, check if the remaining bone stock is sufficient to host the respective component.

NOTE: When replacing a Cemented All Poly Glenoid with a Reverse Glenoid Baseplate or in other revision scenarios, it may be recommended to use a Reverse Glenoid Baseplate with a long peg for increased stability.

8.7 Removal of Convertible Glenoids



Figure 8.26

Place a narrow chisel into the recesses at the PE-Insert sides, between the PE and the Metal-Back. Carefully lever with the chisel so that the Insert can be released and finally removed by gently pulling it out using a forceps.

Alternatively or as a support, a cancellous bone screw can be turned through the PE-Insert. Make sure to not position the screw in the areas of the peripheral or central pegs.



Figure 8.27

NOTE: When removing the UHMWPE-Insert from the Convertible Glenoid Metal-Back, care must be taken not to damage the inner Metal-Back thread. Check the thread inside the Metal-Back for integrity by fitting the threaded Shaft of the Convertible Glenoid Impactor into the Metal-Back and screw it into the central hole. This should be easily feasible and without any resistance.

If applied, remove the central Bone Screw using the Torx 25 Screwdriver and the Ratchet.

Screw the Extraction Adapter into the central hole of the Metal-Back.



Figure 8.28



Figure 8.29

Slide the Slaphammer over the Slaphammer Stem and attach the T-Handle. Screw the assembled Slaphammer onto the Extraction Adapter.

Extract the Convertible Glenoid Metal-Back by carefully sliding the hammer and stabilizing the instrument with your other hand on the T-Handle.

8.8 Removal of Glenospheres

Connect the Torx 20 Screwdriverbit to the Ratchet and introduce the screwdriver tip into the head of the Glenosphere locking screw.

Untighten the screw by turning the Screwdriver counterclockwise. Make sure the screw is completely loose.



Figure 8.30

Slide the Extraction Cap for Glenospheres (metal Cap) over the central rod between the branches of the Handle for Glenospheres.

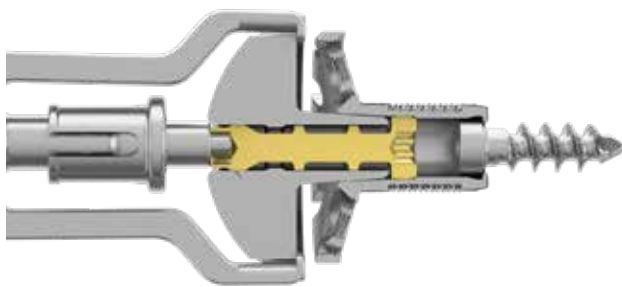

Figure 8.31

Turn the Handle knob counterclockwise in order to open the branches.

Attach the Handle to the implanted Glenosphere, inserting the metal Cap tip into the Glenosphere hole. Position the branches in the lateral Glenosphere grooves.

Turn the instrument knob clockwise to close the branches.



Figure 8.32

Detach the Glenosphere by continued turning the Handle knob clockwise, separating the taper connection between Glenosphere and glenoid component.

To facilitate turning the knob, slide a Screwdriverbit through the knob hole and use it as a T-Handle.

Go on turning the knob clockwise until the Glenosphere is completely separated from the Reverse Baseplate or Metal-Back respectively.

8.9 Removal of Reverse Glenoid Baseplates

After removal of the Glenosphere, remove all peripheral Bone Screws and, if applied, the central Bone Screw using the Torx 25 Screwdriverbit connected to the Ratchet.

Screw the Extraction Adapter into the central hole of the Reverse Baseplate.



Figure 8.33

Slide the Slaphammer over the Slaphammer Stem and attach the T-Handle.

Screw the assembled Slaphammer onto the Extraction Adapter.

Extract the Reverse Baseplate by carefully sliding the hammer and stabilizing the instrument with your other hand on the T-Handle.

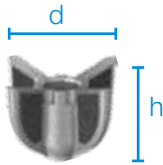

Figure 8.34

9. Implants

Stemless Cages

MAT *Ti/Co*tan-E, Fixation: cementless



REF	Diameter (d) mm	Height (h) mm
640-010/30	30	19
640-010/32	32	20
640-010/34	34	21
640-010/36	36	23
640-010/38	38	24
640-010/40	40	25

Stemless Ring Cages

MAT *Ti/Co*tan-E, Fixation: cementless



REF	Diameter (d) mm	Height (h) mm
640-015/34	34	21
640-015/36	36	23
640-015/38	38	24
640-015/40	40	25

Humeral Short Stems

MAT *Ti/Co*tan-S, Fixation: cementless



REF	Length (l) mm	Diameter (d) mm	Coating/Surface
640-175/12	75	12	CaP-coating
640-175/13	75	13	CaP-coating
640-175/14	75	14	CaP-coating
640-175/15	75	15	CaP-coating
640-175/16	75	16	CaP-coating
640-175/17	75	17	CaP-coating
640-175/18	75	18	CaP-coating
640-175/19	75	19	CaP-coating
640-175/20	75	20	CaP-coating

Humeral Standard Stems

MAT *Tibotan* -S, Fixation: cemented/cementless

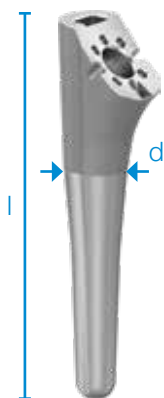

REF	Length (l) mm	Diameter (d) mm	Coating/Surface
640-100/12	100	12	-
640-100/13	100	13	-
640-100/14	100	14	-
640-100/15	100	15	-
640-100/16	100	16	-
640-100/17	100	17	-
640-100/18	100	18	-
640-100/19	100	19	-
640-100/20	100	20	-
640-100/21	100	21	-
640-100/22	100	22	-
640-100/23	100	23	-
640-100/24	100	24	-

Humeral Standard Stems

MAT *Tibotan* -S, Fixation: cementless

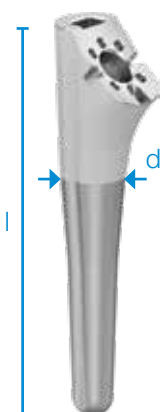

REF	Length (l) mm	Diameter (d) mm	Coating/Surface
640-110/12	100	12	CaP-coating
640-110/13	100	13	CaP-coating
640-110/14	100	14	CaP-coating
640-110/15	100	15	CaP-coating
640-110/16	100	16	CaP-coating
640-110/17	100	17	CaP-coating
640-110/18	100	18	CaP-coating
640-110/19	100	19	CaP-coating
640-110/20	100	20	CaP-coating
640-110/21	100	21	CaP-coating
640-110/22	100	22	CaP-coating
640-110/23	100	23	CaP-coating
640-110/24	100	24	CaP-coating

Humeral Fracture Stems

MAT *Ti/otan*-S, Fixation: cemented/cementless

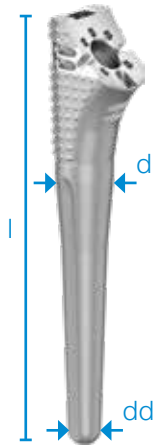

REF	Length (l) mm	Diameter (d) mm	Distal Diameter (dd) mm
641-120/12	120	12	5
641-120/13	120	13	6
641-120/14	120	14	7
641-120/15	120	15	8
641-120/16	120	16	9
641-120/17	120	17	10
641-120/18	120	18	11
641-120/19	120	19	12
641-120/20	120	20	13
641-120/21	120	21	14
641-120/22	120	22	15
641-120/23	120	23	16
641-120/24	120	24	17

Modular Stems

MAT *Ti/otan*-S, Fixation: cemented/cementless



REF	Length (l) mm	Diameter (d) mm	Distal Diameter (dd) mm
641-075/14	75	14	7
641-075/15	75	15	8
641-075/16	75	16	9
641-075/17	75	17	10
641-075/18	75	18	11
641-075/19	75	19	12
641-075/20	75	20	13
641-075/21	75	21	14
641-075/22	75	22	15
641-075/23	75	23	16
641-075/24	75	24	17

Proximal Bodies

MAT *Ti/otan*-S, Fixation: cemented/cementless

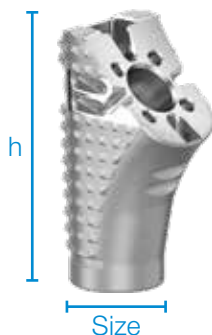

REF	Height (h) mm	Size
641-040/14	- 5	S
641-040/16	- 5	M
641-040/18	- 5	L
641-045/14	± 0	S
641-045/16	± 0	M
641-045/18	± 0	L
641-050/14	+ 5	S
641-050/16	+ 5	M
641-050/18	+ 5	L

Modular Revision Stems

MAT *Ti60tan*-S, Fixation: cemented

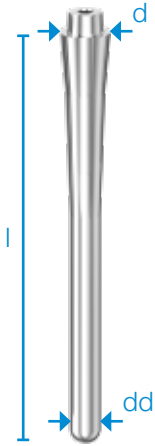

REF	Length (l) mm	Diameter (d) mm	Distal Diameter (dd) mm
641-105/13	105	13	7
641-105/14	105	14	8
641-105/15	105	15	9
641-105/16	105	16	10
641-135/13	135	13	7
641-135/14	135	14	8
641-135/15	135	15	9
641-135/16	135	16	10
641-165/13	165	13	7
641-165/14	165	14	8
641-165/15	165	15	9
641-165/16	165	16	10

Modular Revision Stems

MAT *Ti60tan*-S, Fixation: cementless

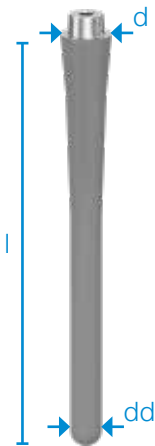

REF	Length (l) mm	Diameter (d) mm	Distal Diameter (dd) mm
641-205/13	105	13	7
641-205/14	105	14	8
641-205/15	105	15	9
641-205/16	105	16	10
641-235/13	135	13	7
641-235/14	135	14	8
641-235/15	135	15	9
641-235/16	135	16	10
641-265/13	165	13	7
641-265/14	165	14	8
641-265/15	165	15	9
641-265/16	165	16	10

Cemented All Poly Glenoids

MAT UHMWPE



REF	Size	Height (h) mm	Width (b) mm	Material
645-001/52	small	28	22	UHMWPE
645-002/58	medium	32	25	UHMWPE
645-003/64	large	36	28	UHMWPE
645-004/64	x-large	40	31	UHMWPE
645-021/52	small	28	22	UHMWPE/E-DUR
645-022/58	medium	32	25	UHMWPE/E-DUR
645-023/64	large	36	25	UHMWPE/E-DUR
645-024/64	x-large	40	31	UHMWPE/E-DUR

Metal-Backs for Convertible Glenoids

MAT Tifotan-E

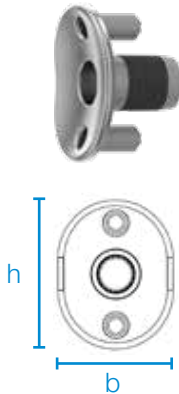

REF	Size	Height (h) mm	Width (b) mm	Fixation
645-041/52	small	27	20	Cementless, Hybrid (Partly Cemented)
645-042/58	medium	30	23	Cementless, Hybrid (Partly Cemented)
645-043/64	large	33	26	Cementless, Hybrid (Partly Cemented)
645-044/64	x-large	37	29	Cementless, Hybrid (Partly Cemented)

Inserts for Convertible Glenoids

MAT UHMWPE

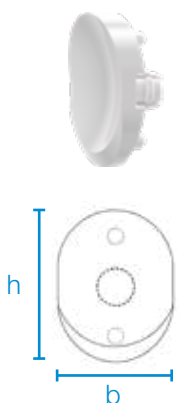

REF	Size	Height (h) mm	Width (b) mm	Material
645-055/52	small	28	22	UHMWPE/E-DUR
645-056/58	medium	32	25	UHMWPE/E-DUR
645-057/64	large	36	28	UHMWPE/E-DUR
645-058/64	x-large	40	31	UHMWPE/E-DUR
645-059/52	small	28	22	UHMWPE
645-060/58	medium	32	25	UHMWPE
645-061/64	large	36	25	UHMWPE
645-062/64	x-large	40	31	UHMWPE

Reverse Glenoid Baseplates

MAT Tifotan-E

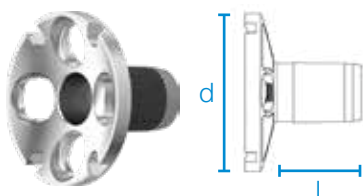

REF	Diameter (d) mm	Length (l) mm	Coating/Surface
645-080/20	28	15	TrabecuLink
645-080/30	28	25	TrabecuLink

Cortical Bone Screws

MAT *Ti60tan*-S, Torx 25



REF	Diameter (mm)	Length (mm)
645-073/20	4.5	20
645-073/25	4.5	25
645-073/30	4.5	30
645-073/35	4.5	35
645-073/40	4.5	40
645-073/50	4.5	50
645-073/60	4.5	60

Cortical Bone Screws - angle-stable

MAT *Ti60tan*-S, Torx 25



REF	Diameter (mm)	Length (mm)
645-075/20	4.5	20
645-075/25	4.5	25
645-075/30	4.5	30
645-075/35	4.5	35
645-075/40	4.5	40
645-075/50	4.5	50
645-075/60	4.5	60

Central Cancellous Bone Screws

MAT *Ti60tan*-S, Torx 25



REF	Diameter (mm)	Length (mm)
645-077/15	6.0	15
645-077/20	6.0	20
645-077/25	6.0	25
645-077/30	6.0	30

Cancellous Bone Screws

MAT *Ti60tan*-S, Torx 25



REF	Diameter (mm)	Length (mm)
645-070/20	6.0	20
645-070/25	6.0	25
645-070/30	6.0	30
645-070/35	6.0	35
645-070/40	6.0	40
645-070/50	6.0	50
645-070/60	6.0	60

Humeral Heads

MAT EndoDur-S (CoCrMo)

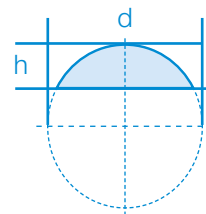

REF	Diameter (d) mm	Height (h) mm	Material	Coating/Surface
642-038/12	38	12	EndoDur-S	-
642-038/14	38	14	EndoDur-S	-
642-041/13	41	13	EndoDur-S	-
642-041/15	41	15	EndoDur-S	-
642-041/17	41	17	EndoDur-S	-
642-044/14	44	14	EndoDur-S	-
642-044/16	44	16	EndoDur-S	-
642-044/18	44	18	EndoDur-S	-
642-047/15	47	15	EndoDur-S	-
642-047/17	47	17	EndoDur-S	-
642-047/19	47	19	EndoDur-S	-
642-050/16	50	16	EndoDur-S	-
642-050/18	50	18	EndoDur-S	-
642-050/20	50	20	EndoDur-S	-
642-053/17	53	17	EndoDur-S	-
642-053/19	53	19	EndoDur-S	-
642-053/21	53	21	EndoDur-S	-
642-138/12	38	12	EndoDur-S/TiNbN	TiNbN
642-138/14	38	14	EndoDur-S/TiNbN	TiNbN
642-141/13	41	13	EndoDur-S/TiNbN	TiNbN
642-141/15	41	15	EndoDur-S/TiNbN	TiNbN
642-141/17	41	17	EndoDur-S/TiNbN	TiNbN
642-144/14	44	14	EndoDur-S/TiNbN	TiNbN
642-144/16	44	16	EndoDur-S/TiNbN	TiNbN
642-144/18	44	18	EndoDur-S/TiNbN	TiNbN
642-147/15	47	15	EndoDur-S/TiNbN	TiNbN
642-147/17	47	17	EndoDur-S/TiNbN	TiNbN
642-147/19	47	19	EndoDur-S/TiNbN	TiNbN
642-150/16	50	16	EndoDur-S/TiNbN	TiNbN
642-150/18	50	18	EndoDur-S/TiNbN	TiNbN
642-150/20	50	20	EndoDur-S/TiNbN	TiNbN
642-153/17	53	17	EndoDur-S/TiNbN	TiNbN
642-153/19	53	19	EndoDur-S/TiNbN	TiNbN
642-153/21	53	21	EndoDur-S/TiNbN	TiNbN

Head Adapters

MAT *TiZotan*-S, Fixation Screw included (*TiZotan*-S)



REF	Version
642-010/00	neutral
642-010/01*	neutral
642-010/02	2 mm offset
642-010/04	4 mm offset
642-010/06	6 mm offset

* with suture holes

Stemless Ring Cage Head Adapters

MAT *TiZotan*-S



REF	Version
642-035/00	neutral
642-035/02	2 mm offset

CTA Heads

MAT EndoDur-S (CoCrMo)

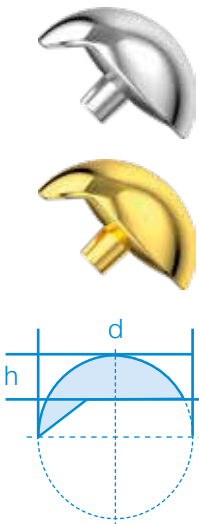

REF	Diameter (d) mm	Height (h) mm	Material	Coating/ Surface
647-044/16	44	16	EndoDur-S	-
647-047/17	47	17	EndoDur-S	-
647-050/18	50	18	EndoDur-S	-
647-053/19	53	19	EndoDur-S	-
647-144/16	44	16	EndoDur-S/ TiNbN	TiNbN
647-147/17	47	17	EndoDur-S/ TiNbN	TiNbN
647-150/18	50	18	EndoDur-S/ TiNbN	TiNbN
647-153/19	53	19	EndoDur-S/ TiNbN	TiNbN

Stemless Ring Cage CTA Head Adapters

MAT *TiZotan*-S



REF	Version
647-040/00	neutral

Humeral Reverse Tray - neutral

MAT EndoDur-S (CoCrMo), Fixation Screw included (*Ti/otan-S*)



REF	Material	Coating/Surface
643-010/00	EndoDur-S	-
643-011/00	EndoDur-S/TiNbN	TiNbN

Humeral Reverse Tray - 3 mm offset

MAT EndoDur-S (CoCrMo), Fixation Screw included (*Ti/otan-S*)



REF	Material	Coating/Surface
643-010/03	EndoDur-S	-
643-011/03	EndoDur-S/TiNbN	TiNbN

Humeral Reverse Tray - inclined 10°

MAT EndoDur-S (CoCrMo), Fixation Screw included (*Ti/otan-S*)

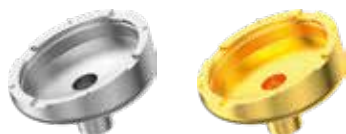

REF	Material	Coating/Surface
643-020/10	EndoDur-S	-
643-021/10	EndoDur-S/TiNbN	TiNbN

Humeral Extender

MAT *Ti/otan-S*



REF	Height (mm)
643-030/09	9

Reverse Inserts

MAT UHMWPE



REF	Height (mm)	Diameter (mm)	Material
643-036/00	0	36	UHMWPE
643-036/03	3	36	UHMWPE
643-036/06	6	36	UHMWPE
643-039/00	0	39	UHMWPE
643-039/03	3	39	UHMWPE
643-039/06	6	39	UHMWPE
643-042/00	0	42	UHMWPE
643-042/03	3	42	UHMWPE
643-042/06	6	42	UHMWPE
643-136/00	0	36	X-LINKed PE
643-136/03	3	36	X-LINKed PE
643-136/06	6	36	X-LINKed PE
643-139/00	0	39	X-LINKed PE
643-139/03	3	39	X-LINKed PE
643-139/06	6	39	X-LINKed PE
643-142/00	0	42	X-LINKed PE
643-142/03	3	42	X-LINKed PE
643-142/06	6	42	X-LINKed PE
643-236/00	0	36	UHMWPE/E-DUR
643-236/03	3	36	UHMWPE/E-DUR
643-236/06	6	36	UHMWPE/E-DUR
643-239/00	0	39	UHMWPE/E-DUR
643-239/03	3	39	UHMWPE/E-DUR
643-239/06	6	39	UHMWPE/E-DUR
643-242/00	0	42	UHMWPE/E-DUR
643-242/03	3	42	UHMWPE/E-DUR
643-242/06	6	42	UHMWPE/E-DUR

Reverse Inserts

MAT EndoDur-S (CoCrMo)



REF	Height (mm)	Diameter (mm)	Material	Coating/Surface
643-539/03	-3	39	EndoDur-S	-
643-339/00	0	39	EndoDur-S	-
643-339/03	3	39	EndoDur-S	-
643-339/06	6	39	EndoDur-S	-
643-542/03	-3	42	EndoDur-S	-
643-342/00	0	42	EndoDur-S	-
643-342/03	3	42	EndoDur-S	-
643-342/06	6	42	EndoDur-S	-
643-639/03	-3	39	EndoDur-S/TiNbN	TiNbN
643-439/00	0	39	EndoDur-S/TiNbN	TiNbN
643-439/03	3	39	EndoDur-S/TiNbN	TiNbN
643-439/06	6	39	EndoDur-S/TiNbN	TiNbN
643-642/03	-3	42	EndoDur-S/TiNbN	TiNbN
643-442/00	0	42	EndoDur-S/TiNbN	TiNbN
643-442/03	3	42	EndoDur-S/TiNbN	TiNbN
643-442/06	6	42	EndoDur-S/TiNbN	TiNbN

Reverse Inserts - inclined 10°

MAT UHMWPE



REF	Height (mm)	Diameter (mm)	Material
643-036/10	0	36	UHMWPE
643-036/13	3	36	UHMWPE
643-036/16	6	36	UHMWPE
643-039/10	0	39	UHMWPE
643-039/13	3	39	UHMWPE
643-039/16	6	39	UHMWPE
643-042/10	0	42	UHMWPE
643-042/13	3	42	UHMWPE
643-042/16	6	42	UHMWPE
643-136/10	0	36	X-LINKed PE
643-136/13	3	36	X-LINKed PE
643-136/16	6	36	X-LINKed PE
643-139/10	0	39	X-LINKed PE
643-139/13	3	39	X-LINKed PE
643-139/16	6	39	X-LINKed PE
643-142/10	0	42	X-LINKed PE
643-142/13	3	42	X-LINKed PE
643-142/16	6	42	X-LINKed PE
643-236/10	0	36	UHMWPE/E-DUR
643-236/13	3	36	UHMWPE/E-DUR
643-236/16	6	36	UHMWPE/E-DUR
643-239/10	0	39	UHMWPE/E-DUR
643-239/13	3	39	UHMWPE/E-DUR
643-239/16	6	39	UHMWPE/E-DUR
643-242/10	0	42	UHMWPE/E-DUR
643-242/13	3	42	UHMWPE/E-DUR
643-242/16	6	42	UHMWPE/E-DUR

Reverse Inserts - inclined 10°

MAT EndoDur-S (CoCrMo)



REF	Height (mm)	Diameter (mm)	Material	Coating/Surface
643-539/13	-3	39	EndoDur-S	
643-339/10	0	39	EndoDur-S	
643-339/13	3	39	EndoDur-S	
643-339/16	6	39	EndoDur-S	
643-542/13	-3	42	EndoDur-S	
643-342/10	0	42	EndoDur-S	
643-342/13	3	42	EndoDur-S	
643-342/16	6	42	EndoDur-S	
643-639/13	-3	39	EndoDur-S/TiNbN	TiNbN
643-439/10	0	39	EndoDur-S/TiNbN	TiNbN
643-439/13	3	39	EndoDur-S/TiNbN	TiNbN
643-439/16	6	39	EndoDur-S/TiNbN	TiNbN
643-642/13	-3	42	EndoDur-S/TiNbN	TiNbN
643-442/10	0	42	EndoDur-S/TiNbN	TiNbN
643-442/13	3	42	EndoDur-S/TiNbN	TiNbN
643-442/16	6	42	EndoDur-S/TiNbN	TiNbN

Reverse Inserts - inclined 20°

MAT UHMWPE



REF	Height (mm)	Diameter (mm)	Material
643-036/20	0	36	UHMWPE
643-036/23	3	36	UHMWPE
643-036/26	6	36	UHMWPE
643-039/20	0	39	UHMWPE
643-039/23	3	39	UHMWPE
643-039/26	6	39	UHMWPE
643-042/20	0	42	UHMWPE
643-042/23	3	42	UHMWPE
643-042/26	6	42	UHMWPE
643-136/20	0	36	X-LINKed PE
643-136/23	3	36	X-LINKed PE
643-136/26	6	36	X-LINKed PE
643-139/20	0	39	X-LINKed PE
643-139/23	3	39	X-LINKed PE
643-139/26	6	39	X-LINKed PE
643-142/20	0	42	X-LINKed PE
643-142/23	3	42	X-LINKed PE
643-142/26	6	42	X-LINKed PE
643-236/20	0	36	UHMWPE/E-DUR
643-236/23	3	36	UHMWPE/E-DUR
643-236/26	6	36	UHMWPE/E-DUR
643-239/20	0	39	UHMWPE/E-DUR
643-239/23	3	39	UHMWPE/E-DUR
643-239/26	6	39	UHMWPE/E-DUR
643-242/20	0	42	UHMWPE/E-DUR
643-242/23	3	42	UHMWPE/E-DUR
643-242/26	6	42	UHMWPE/E-DUR

Reverse Inserts - inclined 20°

MAT EndoDur-S (CoCrMo)



REF	Height (mm)	Diameter (mm)	Material	Coating/Surface
643-339/20	0	39	EndoDur-S	-
643-339/23	3	39	EndoDur-S	-
643-339/26	6	39	EndoDur-S	-
643-342/20	0	42	EndoDur-S	-
643-342/23	3	42	EndoDur-S	-
643-342/26	6	42	EndoDur-S	-
643-439/20	0	39	EndoDur-S/TiNbN	TiNbN
643-439/23	3	39	EndoDur-S/TiNbN	TiNbN
643-439/26	6	39	EndoDur-S/TiNbN	TiNbN
643-442/20	0	42	EndoDur-S/TiNbN	TiNbN
643-442/23	3	42	EndoDur-S/TiNbN	TiNbN
643-442/26	6	42	EndoDur-S/TiNbN	TiNbN

Glenospheres - neutral

MAT EndoDur-S (CoCrMo), with locking screw (EndoDur + TiNbN)



REF	Diameter (mm)	Material	Coating/Surface
646-036/00	36	EndoDur-S	-
646-039/00	39	EndoDur-S	-
646-042/00	42	EndoDur-S	-
646-136/00	36	EndoDur-S/TiNbN	TiNbN
646-139/00	39	EndoDur-S/TiNbN	TiNbN
646-142/00	42	EndoDur-S/TiNbN	TiNbN

Glenospheres - eccentric

MAT EndoDur-S (CoCrMo), with locking screw (EndoDur + TiNbN)



REF	Diameter (mm)	Eccentricity (mm)	Material	Coating/Surface
646-036/03	36	3.0	EndoDur-S	-
646-039/03	39	3.5	EndoDur-S	-
646-042/03	42	4.0	EndoDur-S	-
646-136/03	36	3.0	EndoDur-S/TiNbN	TiNbN
646-139/03	39	3.5	EndoDur-S/TiNbN	TiNbN
646-142/03	42	4.0	EndoDur-S/TiNbN	TiNbN

Glenosphere PE-Domes - neutral

MAT UHMWPE/E-DUR



REF	Diameter (mm)	Material
646-239/00	39	UHMWPE/E-DUR
646-242/00	42	UHMWPE/E-DUR

Glenosphere PE-Domes - eccentric

MAT UHMWPE/E-DUR



REF	Diameter (mm)	Eccentricity (mm)	Material
646-239/03	39	3.5	UHMWPE/E-DUR
646-242/03	42	4.0	UHMWPE/E-DUR

Metal Core for Glenosphere PE Domes

MAT EndoDur-S (CoCrMo), with locking screw (EndoDur-S + TiNbN)



REF	Material	Coating/Surface
646-001/06	EndoDur-S/TiNbN	TiNbN

10. Instruments

650-001/00 General Set

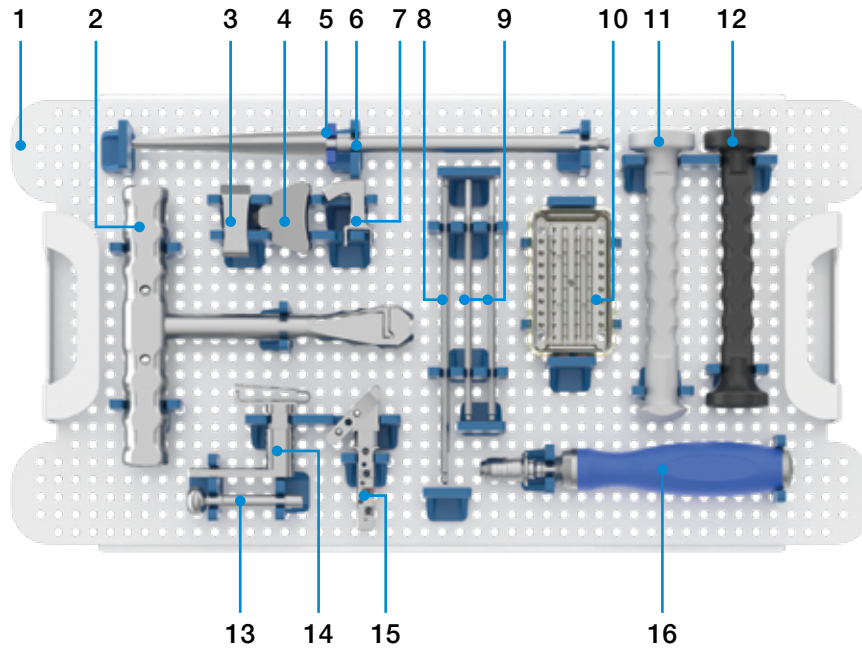

1	650-011/00	General Set Tray
2	15-6053/00	T-Handle (Hudson fitting)
3	632-005/02	Resection Block (for Delto-Pectoral Approach)
4	632-005/07	Resection Block (for Lateral Approach)
5	630-001/11	Depth Stop Disk
6	630-001/10	Starter Awl
7	632-005/09	Alignment Rod Connector
8	630-001/06	Screwdriverbit (T25, for Bone Screws)
9	632-005/08 × 2	Alignment Rod
10	319-601/30	Sterilizing Box , contains:
	632-005/65 × 4	Fixation Pin
11	643-001/01	Impactor (for Reverse Inserts and PE Glenoids)
12	632-001/01	Impactor (for Humeral Heads)
13	632-005/01	Resection Guide Connector
14	632-005/00	Resection Guide (for Humeral Head)
15	632-005/10	Extramedullary Resection Guide
16	134-220/03	Torque Wrench, 3 Nm (AO fitting)

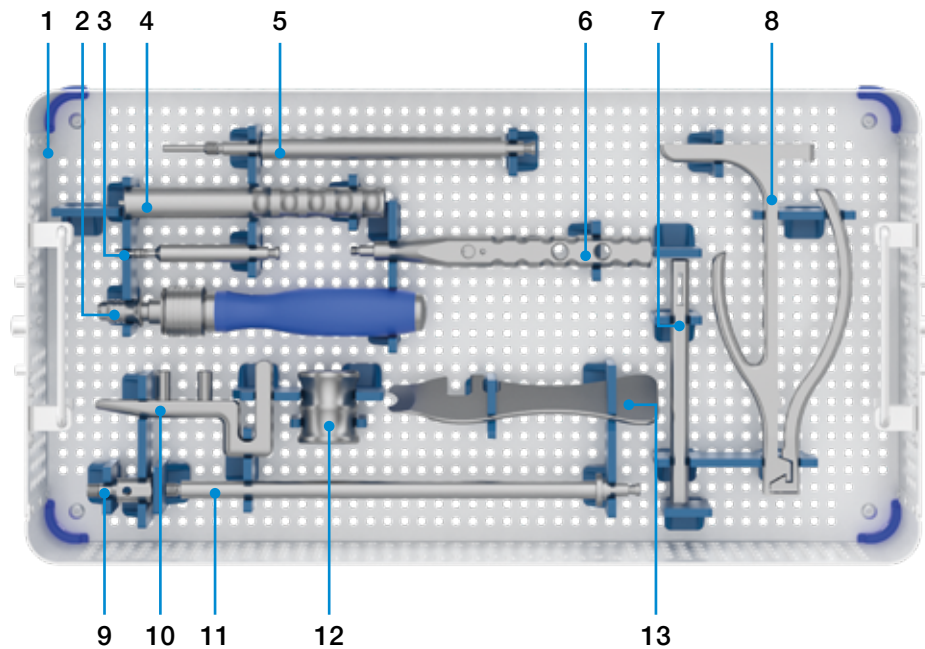

1	650-011/00	General Set Tray
2	80-2014	Ratchet Handle (AO fitting)
3	645-090/13	Reverse Tray Extraction Bolt
4	645-090/11	Counter Sleeve (for Head Adapter Extraction Bolt)
5	645-090/09	Head Adapter Extraction Bolt
6	631-001/01	Impactor (for Modular Stems)
7	445-121/00	Pin Inserter, universal
8	445-120/00	Pin Inserter/Extractor, universal
9	645-090/07	Extraction Adapter (for Convertible Metal-Back and Reverse Baseplate)
10	645-090/01	Extraction Hook
11	645-090/03	Stem for Slaphammer
12	645-090/05	Slaphammer
13	645-090/21	Separator Wrench

650-002/00 Stemless Set

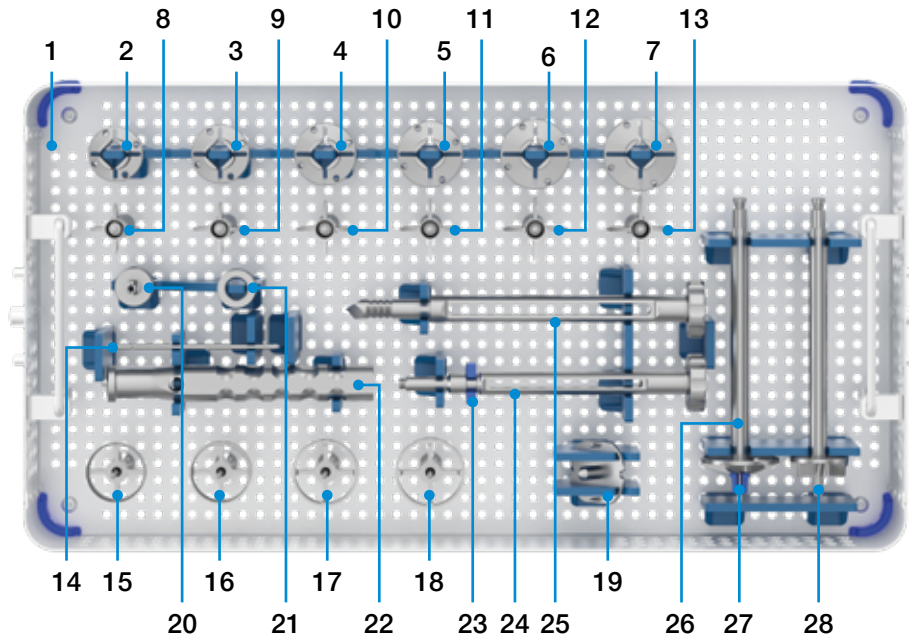

1	650-012/00	Stemless Set Tray
2	640-510/30	Sizer Disk 30 mm (for Stemless Cage)
3	640-510/32	Sizer Disk 32 mm (for Stemless Cage)
4	640-510/34	Sizer Disk 34 mm (for Stemless Cage/Ring Cage)
5	640-510/36	Sizer Disk 36 mm (for Stemless Cage/Ring Cage)
6	640-510/38	Sizer Disk 38 mm (for Stemless Cage/Ring Cage)
7	640-510/40	Sizer Disk 40 mm (for Stemless Cage/Ring Cage)
8	640-520/30	Punch/Trial Cage 30 mm (for Stemless Cage)
9	640-520/32	Punch/Trial Cage 32 mm (for Stemless Cage)
10	640-520/34	Punch/Trial Cage 34 mm (for Stemless Cage/Ring Cage)
11	640-520/36	Punch/Trial Cage 36 mm (for Stemless Cage/Ring Cage)
12	640-520/38	Punch/Trial Cage 38 mm (for Stemless Cage/Ring Cage)
13	640-520/40	Punch/Trial Cage 40 mm (for Stemless Cage/Ring Cage)
14	640-501/15	K-Wire (for Stemless/Stemless Ring Cage preparation)
15	640-530/34	Punch/Trial Cage 34 mm (for Stemless Ring Cage)
16	640-530/36	Punch/Trial Cage 36 mm (for Stemless Ring Cage)
17	640-530/38	Punch/Trial Cage 38 mm (for Stemless Ring Cage)
18	640-530/40	Punch/Trial Cage 40 mm (for Stemless Ring Cage)
19	630-001/15	Humerus Protection Plate, neutral
20	640-501/13	Sizer Sleeve (for Stemless/Stemless Ring Cage preparation)
21	640-501/07	Center Sleeve (for Central Peg Punch)
22	640-501/03	Sleeve (for Impactor)
23	630-001/11	Depth Stop Disk (for Starter Awl and Stemless Impactor)
24	640-501/01	Impactor (for Stemless Cages/Ring Cages)
25	640-501/09	Central Peg Punch
26	630-001/07	Finishing Reamer
27	630-001/09	Sleeve (for Finishing Reamer)
28	640-501/11	Reamer (for Stemless Ring Cage Preparation)

650-003/00 Short & Standard Stem Set

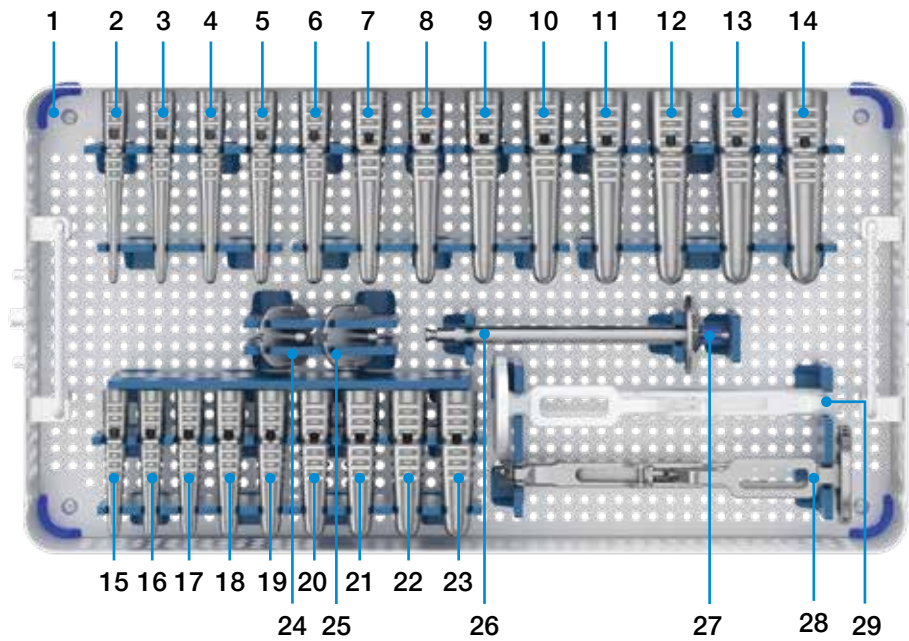

1	650-013/00	Short & Standard Stem Set Tray
2	630-100/12	Compressor (for Humeral Standard Stems), Ø 12
3	630-100/13	Compressor (for Humeral Standard Stems), Ø 13
4	630-100/14	Compressor (for Humeral Standard Stems), Ø 14
5	630-100/15	Compressor (for Humeral Standard Stems), Ø 15
6	630-100/16	Compressor (for Humeral Standard Stems), Ø 16
7	630-100/17	Compressor (for Humeral Standard Stems), Ø 17
8	630-100/18	Compressor (for Humeral Standard Stems), Ø 18
9	630-100/19	Compressor (for Humeral Standard Stems), Ø 19
10	630-100/20	Compressor (for Humeral Standard Stems), Ø 20
11	630-100/21	Compressor (for Humeral Standard Stems), Ø 21
12	630-100/22	Compressor (for Humeral Standard Stems), Ø 22
13	630-100/23	Compressor (for Humeral Standard Stems), Ø 23
14	630-100/24	Compressor (for Humeral Standard Stems), Ø 24
15	630-075/12	Compressor (for Humeral Short Stems), Ø 12
16	630-075/13	Compressor (for Humeral Short Stems), Ø 13
17	630-075/14	Compressor (for Humeral Short Stems), Ø 14
18	630-075/15	Compressor (for Humeral Short Stems), Ø 15
19	630-075/16	Compressor (for Humeral Short Stems), Ø 16
20	630-075/17	Compressor (for Humeral Short Stems), Ø 17
21	630-075/18	Compressor (for Humeral Short Stems), Ø 18
22	630-075/19	Compressor (for Humeral Short Stems), Ø 19
23	630-075/20	Compressor (for Humeral Short Stems), Ø 20
24	630-001/14	Humerus Protection Plate, 6 mm Offset
25	630-001/15	Humerus Protection Plate, neutral
26	630-001/07	Finishing Reamer
27	630-001/09	Sleeve (for Finishing Reamer)
28	630-001/01	Handle (for Compressors and Proximal Bodies)
29	630-001/01	Handle (for Compressors and Proximal Bodies, on request)

650-004/00 Modular Stem & Modular Revision Stem Set

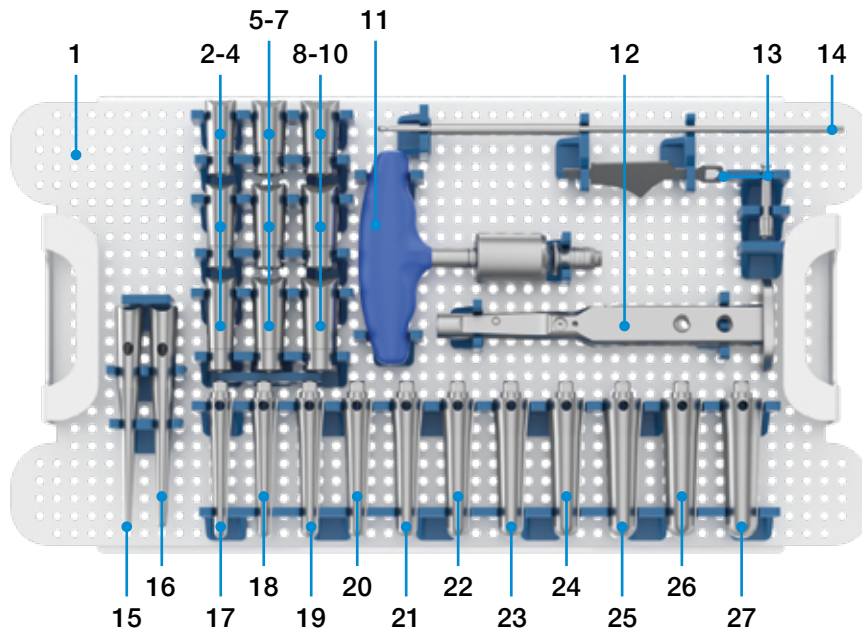

1	650-014/00	Modular Stem & Modular Revision Stem Set Tray
2	631-040/14	Proximal Trial Body, S, - 5
3	631-045/14	Proximal Trial Body, S, ± 0
4	631-050/14	Proximal Trial Body, S, + 5
5	631-040/16	Proximal Trial Body, M, -5
6	631-045/16	Proximal Trial Body, M, ± 0
7	631-050/16	Proximal Trial Body, M, + 5
8	631-040/18	Proximal Trial Body, L, - 5
9	631-045/18	Proximal Trial Body, L, ± 0
10	631-050/18	Proximal Trial Body, L, + 5
11	630-001/04	Torque Wrench, 5 Nm (AO fitting)
12	631-001/03	Handle (for Modular Trial Stems)
13	631-001/05	Template (for Proximal Bodies)
14	630-001/05	Screwdriverbit (T25, for Handle f. Compr. a. Prox. Bodies)
15	631-010/12	Humeral Fracture Trial Stem, Ø 12
16	631-010/13	Humeral Fracture Trial Stem, Ø 13
17	631-075/14	Modular Trial Stem, Ø 14, L75 mm
18	631-075/15	Modular Trial Stem, Ø 15, L75 mm
19	631-075/16	Modular Trial Stem, Ø 16, L75 mm
20	631-075/17	Modular Trial Stem, Ø 17, L75 mm
21	631-075/18	Modular Trial Stem, Ø 18, L75 mm
22	631-075/19	Modular Trial Stem, Ø 19, L75 mm
23	631-075/20	Modular Trial Stem, Ø 20, L75 mm
24	631-075/21	Modular Trial Stem, Ø 21, L75 mm
25	631-075/22	Modular Trial Stem, Ø 22, L75 mm
26	631-075/23	Modular Trial Stem, Ø 23, L75 mm
27	631-075/24	Modular Trial Stem, Ø 24, L75 mm

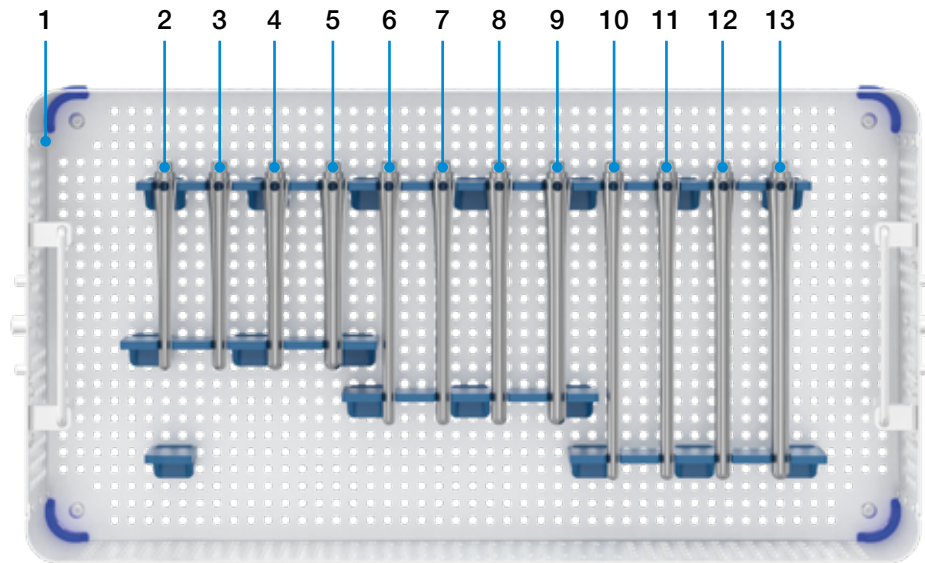

1	650-014/00	Modular Stem & Modular Revision Stem Set Tray
2	631-105/13	Modular Revision Trial Stem, Ø 13, L105 mm
3	631-105/14	Modular Revision Trial Stem, Ø 14, L105 mm
4	631-105/15	Modular Revision Trial Stem, Ø 15, L105 mm
5	631-105/16	Modular Revision Trial Stem, Ø 16, L105 mm
6	631-135/13	Modular Revision Trial Stem, Ø 13, L135 mm
7	631-135/14	Modular Revision Trial Stem, Ø 14, L135 mm
8	631-135/15	Modular Revision Trial Stem, Ø 15, L135 mm
9	631-135/16	Modular Revision Trial Stem, Ø 16, L135 mm
10	631-165/13	Modular Revision Trial Stem, Ø 13, L165 mm
11	631-165/14	Modular Revision Trial Stem, Ø 14, L165 mm
12	631-165/15	Modular Revision Trial Stem, Ø 15, L165 mm
13	631-165/16	Modular Revision Trial Stem, Ø 16, L165 mm

650-005/00 Glenoid Set

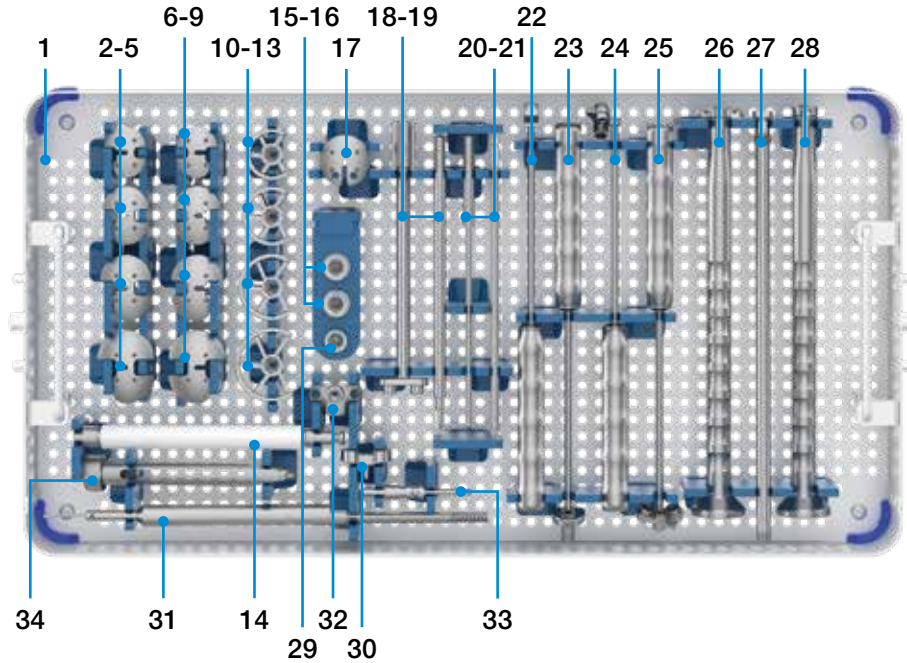

1	650-015/00	Glenoid Set Tray
2	645-001/09	Glenoid Sizer, left, small
3	645-001/11	Glenoid Sizer, left, medium
4	645-001/13	Glenoid Sizer, left, large
5	645-001/15	Glenoid Sizer, left, x-large
6	645-001/10	Glenoid Sizer, right, small
7	645-001/12	Glenoid Sizer, right, medium
8	645-001/14	Glenoid Sizer, right, large
9	645-001/16	Glenoid Sizer, right, x-large
10	645-001/28	Glenoid Reamer, small (Ø 28)
11	645-001/32	Glenoid Reamer, medium (Ø 32)
12	645-001/36	Glenoid Reamer, large (Ø 36)
13	645-001/40	Glenoid Reamer, x-large (Ø 40)
14	645-001/01	Drive Shaft (for Glenoid Preparation, cannulated, Hudson fitting)
15	645-002/03	Drill, standard (for Reverse Glen. Baseplate a. MB f. Convertible Glen., for Central Peg)
16	645-002/05	Drill, long (for Reverse Glenoid Baseplate, for Central Peg)
17	645-002/28	K-Wire Positioner for Reverse Baseplate

18	645-002/12	Guide Handle (for K-Wire)
19	645-002/07	Drill (for Glenoids, for Peripheral Pegs)
20	64-8022	Twist Drill, Ø 3.2
21	80-2030	Screwdriverbit (T20, for Glenospheres)
22	645-080/50	Handle (for Glenoid Sizers and Drill Templates)
23	645-080/60	Drill Guide (for Central Screws)
24	645-080/52	Drill Guide A/P monoaxial
25	645-080/54	Drill Guide “S/I” polyaxial
26	645-080/56	Impactor (for Reverse Baseplate)
27	645-080/59	Shaft for Impactor (for Convert. MB and Reverse Baseplate)
28	645-080/58	Impactor (for Convertible Metal-Back)
29	645-002/01	Drill (for Cemented All Poly Glenoids, for Central Peg)
30	645-002/09	Drill Template (for Cemented All Poly Glenoids, for Peripheral Pegs)
31	645-080/64	Depth Gauge (for Bone Screws)
32	645-003/09	Drill Template (for Convertible Metal-Back, for Peripheral Pegs)
33	645-002/08	Fixation Pin (for Drill Templates)
34	645-002/15	Repositioner (for K-Wire)

650-006/00 Anatomical Set

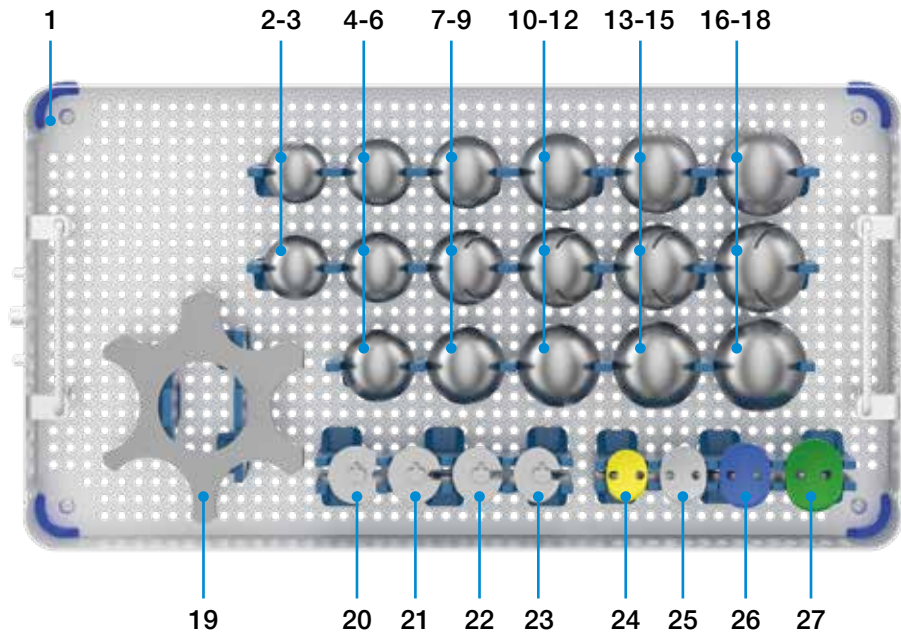

1	650-016/00	Anatomical Set Tray
2	632-038/12	Humeral Trial Head, Ø 38, H12 mm
3	632-038/14	Humeral Trial Head, Ø 38, H14 mm
4	632-041/13	Humeral Trial Head, Ø 41, H13 mm
5	632-041/15	Humeral Trial Head, Ø 41, H15 mm
6	632-041/17	Humeral Trial Head, Ø 41, H17 mm
7	632-044/14	Humeral Trial Head, Ø 44, H14 mm
8	632-044/16	Humeral Trial Head, Ø 44, H16 mm
9	632-044/18	Humeral Trial Head, Ø 44, H18 mm
10	632-047/15	Humeral Trial Head, Ø 47, H15 mm
11	632-047/17	Humeral Trial Head, Ø 47, H17 mm
12	632-047/19	Humeral Trial Head, Ø 47, H19 mm
13	632-050/16	Humeral Trial Head, Ø 50, H16 mm
14	632-050/18	Humeral Trial Head, Ø 50, H18 mm
15	632-050/20	Humeral Trial Head, Ø 50, H20 mm
16	632-053/17	Humeral Trial Head, Ø 53, H17 mm
17	632-053/19	Humeral Trial Head, Ø 53, H19 mm
18	632-053/21	Humeral Trial Head, Ø 53, H21 mm
19	632-001/05	Sizing Gauge (for Humeral Heads)
20	632-010/00	Head Trial Adapter (neutral)
21	632-010/02	Head Trial Adapter (2 mm offset)
22	632-010/04	Head Trial Adapter (4 mm offset)
23	632-010/06	Head Trial Adapter (6 mm offset)
24	645-004/09	Trial for Cemented All Poly Glenoid, small
25	645-004/11	Trial for Cemented All Poly Glenoid, medium
26	645-004/13	Trial for Cemented All Poly Glenoid, large
27	645-004/15	Trial for Cemented All Poly Glenoid, x-large

650-007/00 Reverse Set

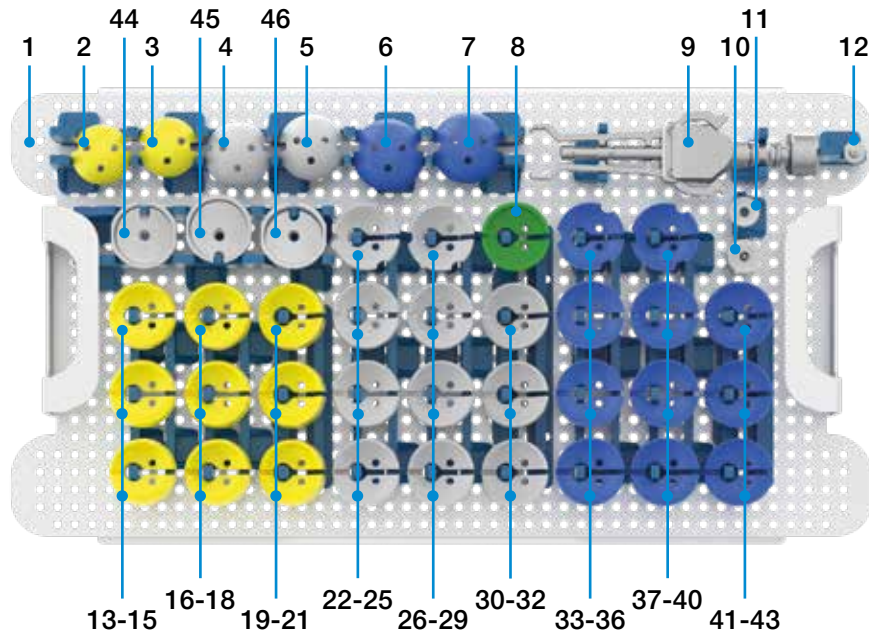

1	650-017/00	Reverse Set Tray
2	646-536/03	Trial Glenosphere, Ø 36, eccentric
3	646-536/00	Trial Glenosphere, Ø 36, neutral
4	646-539/03	Trial Glenosphere, Ø 39, eccentric
5	646-539/00	Trial Glenosphere, Ø 39, neutral
6	646-542/03	Trial Glenosphere, Ø 42, eccentric
7	646-542/00	Trial Glenosphere, Ø 42, neutral
8	643-930/09	Humeral Trial Extender
9	646-530/00	Handle for Glenospheres
10	646-530/04	Cap (for eccentric Glenospheres)
11	646-530/02	Cap (for neutral Glenospheres)
12	645-090/23	Extraction Cap (for Glenosphere Removal)
13	643-836/00	Reverse Trial Insert, Ø 36, H0 mm
14	643-836/03	Reverse Trial Insert, Ø 36, H3 mm
15	643-836/06	Reverse Trial Insert, Ø 36, H6 mm
16	643-836/10	Reverse Trial Insert, Ø 36, H0 mm, 10°
17	643-836/13	Reverse Trial Insert, Ø 36, H3 mm, 10°
18	643-836/16	Reverse Trial Insert, Ø 36, H6 mm, 10°
19	643-836/20	Reverse Trial Insert, Ø 36, H0 mm, 20°
20	643-836/23	Reverse Trial Insert, Ø 36, H3 mm, 20°
21	643-836/26	Reverse Trial Insert, Ø 36, H6 mm, 20°
22	643-839/33	Reverse Trial Insert, Ø 39, H-3 mm
23	643-839/00	Reverse Trial Insert, Ø 39, H0 mm
24	643-839/03	Reverse Trial Insert, Ø 39, H3 mm
25	643-839/06	Reverse Trial Insert, Ø 39, H6 mm

Continue on next page >

26	643-839/43	Reverse Trial Insert, Ø 39, H-3 mm, 10°
27	643-839/10	Reverse Trial Insert, Ø 39, H0 mm, 10°
28	643-839/13	Reverse Trial Insert, Ø 39, H3 mm, 10°
29	643-839/16	Reverse Trial Insert, Ø 39, H6 mm, 10°
30	643-839/20	Reverse Trial Insert, Ø 39, H0 mm, 20°
31	643-839/23	Reverse Trial Insert, Ø 39, H3 mm, 20°
32	643-839/26	Reverse Trial Insert, Ø 39, H6 mm, 20°
33	643-842/33	Reverse Trial Insert, Ø 42, H-3 mm
34	643-842/00	Reverse Trial Insert, Ø 42, H0 mm
35	643-842/03	Reverse Trial Insert, Ø 42, H3 mm
36	643-842/06	Reverse Trial Insert, Ø 42, H6 mm
37	643-842/43	Reverse Trial Insert, Ø 42, H-3 mm, 10°
38	643-842/10	Reverse Trial Insert, Ø 42, H0 mm, 10°
39	643-842/13	Reverse Trial Insert, Ø 42, H3 mm, 10°
40	643-842/16	Reverse Trial Insert, Ø 42, H6 mm, 10°
41	643-842/20	Reverse Trial Insert, Ø 42, H0 mm, 20°
42	643-842/23	Reverse Trial Insert, Ø 42, H3 mm, 20°
43	643-842/26	Reverse Trial Insert, Ø 42, H6 mm, 20°
44	643-910/00	Reverse Trial Tray (neutral)
45	643-910/03	Reverse Trial Tray (3 mm offset)
46	643-920/10	Reverse Trial Tray (10° inclined)

650-007/00 Reverse Set

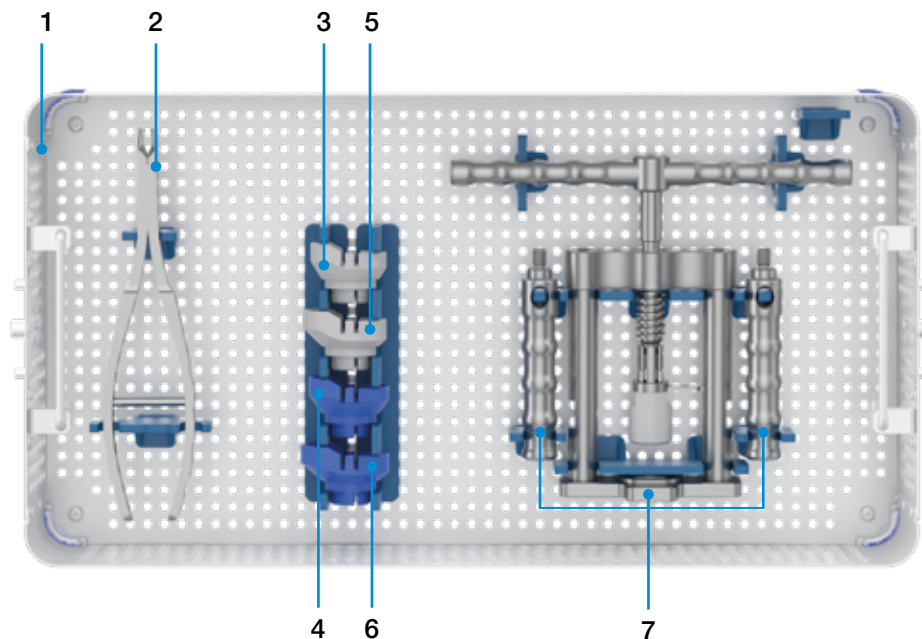

1	650-017/00	Reverse Set Tray
2	15-2042	Insertion Forceps
3	646-530/16	Support for Press, Ø 39, eccentric
4	646-530/18	Support for Press, Ø 42, eccentric
5	646-530/15	Support for Press, Ø 39, neutral
6	646-530/17	Support for Press, Ø 42, neutral
7	646-530/11	Press

X-ray Templates

1	650-030/00	Stemless Cages & Stemless Ring Cages
2	650-030/01	Humeral Short & Humeral Standard Stems
3	650-030/02	Proximal Bodies & Modular Stems/ Modular Revision Stems & Humeral Fracture Stems
4	650-030/03	Humeral Heads & Head Adapters, CTA Heads
5	650-030/04	Cemented All Poly Glenoids & Convertible Glenoids
6	650-030/05	Reverse Trays & Reverse Inserts & Humeral Extender
7	650-030/06	Reverse Glenoid Baseplates & Glenospheres

11. Indications/Contraindications

Indications
Anatomic Elective
A severely painful and/ or disabled shoulder joint resulting from osteoarthritis, traumatic arthritis or rheumatoid arthritis
Avascular necrosis of the humeral head
Deformity and/ or limited motion
Stemless Cage and Stemless Ring Cage Anatomic
Centered osteoarthritis of the shoulder
Humeral head fractures
Rheumatoid arthritis (with intact rotator cuff)
Avascular necrosis of the humeral head
Reverse
Offset osteoarthritis of the shoulder
Massive and non-repairable rotator cuff tears
Rheumatoid arthritis (with degenerative rotator cuff)
Fracture and Revision
Fracture-dislocations of the proximal humerus where the articular surface is severely comminuted, separated from its blood supply or where the surgeon's experience indicates that alternative methods of treatment are unsatisfactory
Other difficult clinical problems where shoulder arthrodesis or resection arthroplasty are not acceptable (e.g., revision of a failed primary component)
Ununited humeral head fractures
Rotator Cuff Tear, Reverse and CTA (including Stemless Ring Cage)
Rotator cuff tear arthropathy
Grossly rotator cuff deficient joint with severe arthropathy or a previously failed joint replacement with a grossly rotator cuff deficient joint
Proximal humerus fracture with insufficient rotator cuff function
Complex shoulder fractures of proximal humerus and glenoid with limited rotator cuff function or irreconstructable rotator cuff

Contraindications
Acute or chronic infections, local and systemic (for example sepsis/ septicaemia) insofar as they compromise the successful implantation of a hemi or total shoulder endoprosthesis
Any inflammatory process which might increase the risk of postoperative infection
Inadequate bone stock in the proximal humerus or glenoid fossa for supporting the components (for example caused by persistent acute or chronic osteomyelitis, or Paget's disease)
Absent, irreparable or nonfunctional rotator cuff or other essential muscles in cases of anatomic reconstruction
Axillary nerve lesions in cases of rotator cuff tear
Deltoid muscle insufficiency
Neurological impairments such as plexus paralysis after trauma, half side paralysis after stroke, cervical spine disc prolaps with following paralysis of relevant shoulder stabilisators, neuroarthropathy etc.
Systemic disorders reducing the cardiocirculatory capacity in respect of surviving the surgical operative trauma, such as COPD Gold 4, ASA 5, NYHA IV etc.
Any mental or neuromuscular disorder which would create an unacceptable risk of prosthesis instability, prosthesis fixation failure, complications in postoperative care or patient compliance
Obesity. An overweight or obese patient can produce loads on the prosthesis which can lead to failure of fixation of the device or to failure of the device itself
Local bone tumors

12. System Compatibility

This chapter comprises all tables showing component compatibility and restrictions within the LINK Embrace Shoulder system. For further information refer to the specified chapter.

CTA Head Combinations with Stemless Cages and Stemless Ring Cages

Chapter 4.5 CTA

CTA Head		Combinations with Stemless Cages/Stemless Ring Cages	
Size	Height		
44	16	✓ sizes 30 - 38	✗ size 40
47	17	✓ all sizes	
50	18	✓ all sizes	
53	19	✓ all sizes	

Table 4.1: Allowed CTA Head-Stemless Cage/Stemless Ring Cage combinations are marked in green. Red combinations are not allowed. Numerical data in mm.

Humeral Heads and Glenoids Combinations

Chapter 5.3 Glenoid Preparation (for cemented All Poly and Convertible Glenoids)

Glenoid Size	Curvature Diameter	Head Size					
		38	41	44	47	50	53
small	52	✓	✓	✓	✓	✗	✗
medium	58	✓	✓	✓	✓	✓	✓
large	64	✗	✗	✓	✓	✓	✓
x-large	64	✗	✗	✓	✓	✓	✓

Table 5.1: Allowed Head-Glenoid combinations are marked in green. Red combinations are not allowed. Numerical data in mm.

Reverse Inserts: Types and Allowed Combinations

Chapter 6.4 Reverse Humeral Component Trialing

Reverse Humeral Inserts			
Diameter	Inclination	Heights	
		UHMWPE	EndoDur
36	0°	0, 3, 6	X
	10°	0, 3, 6	X
	20°	0, 3, 6	X
39	0°	0, 3, 6	-3, 0, 3, 6
	10°	0, 3, 6	-3, 0, 3, 6
	20°	0, 3, 6	0, 3, 6
42	0°	0, 3, 6	-3, 0, 3, 6
	10°	0, 3, 6	-3, 0, 3, 6
	20°	0, 3, 6	0, 3, 6
to be combined with Glenospheres made of:		EndoDur	UHMWPE

Table 6.1: Reverse Inserts: types and allowed combinations. Numerical data in mm unless otherwise noted.

Convertible Glenoids and Glenospheres Combinations

Chapter 7.4 Conversions of Anatomic Glenoids into Reverse Configuration

Convertible Glenoid Size	Glenosphere Type (material, type, diameter)									
	EndoDur						UHMWPE			
	neutral			eccentric			neutral		eccentric	
	36	39	42	36	39	42	39	42	39	42
small	✓	✓	✓	✓	✓	✓	✓	✓	✓	✓
medium	✓	✓	✓	✓	✓	✓	✓	✓	✓	✓
large	✗	✓	✓	✗	✓	✓	✗	✓	✓	✓
x-large	✗	✗	✗	✗	✗	✗	✗	✗	✗	✗

Table 7.1: Allowed combinations of Convertible Glenoid Metal-Backs and Glenospheres are marked in green. Red combinations are not allowed. Numerical data in mm.

Please note the following regarding the use of our implants:

1. Choosing the right implant is very important.

The size and shape of the human bone determines the size and shape of the implant and also limits the load capacity.

Implants are not designed to withstand unlimited physical stress. Demands should not exceed normal functional loads.

2. Correct handling of the implant is very important.

Under no circumstances should the shape of a finished implant be altered, as this shortens its life span. Our implants must not be combined with implants from other manufacturers. The instruments indicated in the Surgical Technique must be used to ensure safe implantation of the components.

3. Implants must not be reused.

Implants are supplied sterile and are intended for single use only. Used implants must not be used again.

4. After-treatment is also very important.

The patient must be informed of the limitations of the implant. The load capacity of an implant cannot compare with that of healthy bone!

5. Unless otherwise indicated, implants are supplied in sterile packaging.

Note the following conditions for storage of packaged implants:

- Avoid extreme or sudden changes in temperature.
- Sterile implants in their original, intact protective packaging may be stored in permanent buildings up until the "Use by" date indicated on the packaging.
- They must not be exposed to frost, dampness or direct sunlight, or mechanical damage.
- Implants may be stored in their original packaging for up to 5 years after the date of manufacture. The "Use by" date is indicated on the product label.
- Do not use an implant if the packaging is damaged.

6. Traceability is important.

Please use the documentation stickers provided to ensure traceability.

7. Further information on the material composition is available on request from the manufacturer.

Follow the instructions for use!

Waldemar Link GmbH & Co. KG, Hamburg

All content in this catalog, including text, pictures and data, is protected by law. Every instance of use, whether in part or in whole and which is not permitted by law, is subject to our prior consent. In particular, this applies to the reproduction, editing, translation, publishing, saving, processing, or passing on of content stored in databases or other electronic media and systems, in any manner or form. The information in the catalogs is solely intended to describe the products and does not constitute a guarantee.

The Surgical Technique described has been written to the best of our knowledge and belief, but it does not relieve the surgeon of his/her responsibility to duly consider the particularities of each individual case.

Products shown in this document may not be available in your country. The product availability is subject to the approval and/or registration regulations of the respective country. Please contact Waldemar Link GmbH & Co. KG if you have questions about the availability of LINK products in your country.

Waldemar Link GmbH & Co. KG and/or other corporate affiliated entities own, use or have applied for the following trademarks in many jurisdictions: LINK, BiMobile, SP II, Modell Lubinus, E-Dur, EndoDur, T.O.P. II, BetaCup, CombiCup PF, CombiCup SC, CombiCup R, MobileLink, C.F.P., LCU, SP-CL, LCP, MIT-H, Endo-Model, Endo-Model SL, MP, MEGASYSTEM-C, GEMINI SL, SPAR-K, LCK, Link OptiStem, HX, TiCaP, X-LINKed, PorAg, LINK PorEx, BiPorEx, PorEx-Z, TrabecuLink, Tilastan, customLINK, RescueSleeve, Stactip, VACUCAST.

Other trademarks and trade names may be used in this document to refer to either the entities claiming the marks and/or names or their products and are the property of their respective owners.

Waldemar Link GmbH & Co. KG and/or other corporate affiliated entities own, use or have applied for the following trademarks in many jurisdictions: LINK, BiMobile, SP II, Modell Lubinus, E-Dur, EndoDur, T.O.P. II, BetaCup, CombiCup PF, CombiCup SC, CombiCup R, MobileLink, C.F.P., LCU, SP-CL, LCP, MIT-H, Endo-Model, Endo-Model SL, MP, MEGASYSTEM-C, GEMINI SL, SPAR-K, LCK, HX, TiCaP, X-LINKed, PorAg, LINK PorEx, BiPorEx, PorEx-Z, TrabecuLink, Tilastan, customLink, RescueSleeve, VACUCAST.

Other trademarks and trade names may be used in this document to refer to either the entities claiming the marks and/or names or their products and are the property of their respective owners.

